



2024

# Environmental Best Management Practices & Design Standards

Prepared By:  
City of Bellevue Parks & Community Services  
Natural Resource, Resource Management & Planning Divisions

# Acknowledgements

---

Thank you to everyone who contributed to this document's development and creation. It could not have been done without the time, input, and expertise of everyone involved.

Parks Natural Resource Division  
Parks Resource Management Division  
Parks Planning Division  
Utilities Department  
Developmental Services Department

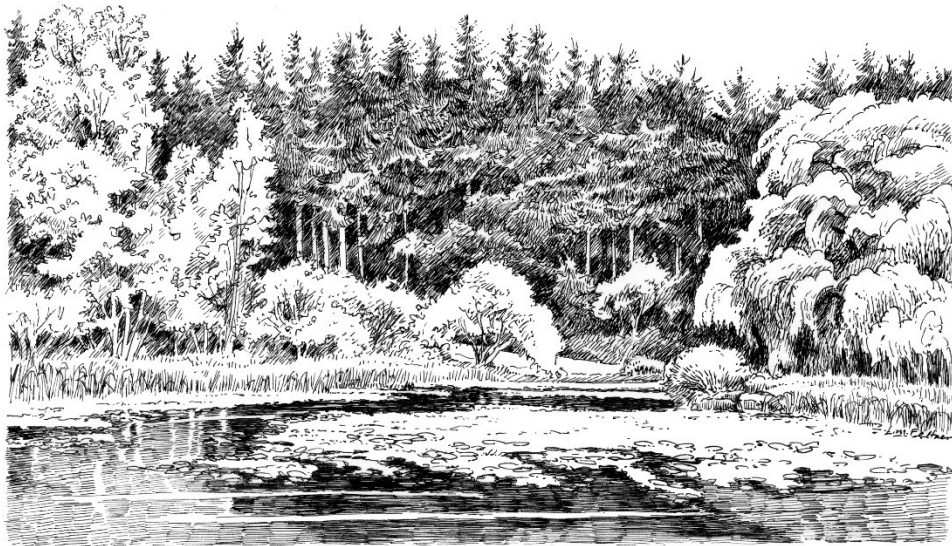

# Table of Contents

---

Acknowledgements.....	i
Introduction .....	iii
How to Use This Manual.....	iv
Chapter 1: Construction Site Management .....	1
Chapter 2: Stormwater Pollution Prevention Plan for Park Operations .....	11
Chapter 3: Integrated Pest Management (IPM) .....	29
Chapter 4: Irrigation and Water Management.....	57
Chapter 5: Nursery Operations .....	65
Chapter 6: Planting Bed Management .....	69
Chapter 7: Turf Management.....	77
Chapter 8: Streetscape Management .....	87
Chapter 9: Trees and Natural Areas .....	111
Chapter 10: Trail System Management.....	133
Chapter 11: Agricultural Areas .....	141
Glossary.....	149
References .....	155

## Appendices

1. Parks & Community Services Water Shortage Response Plan
2. Parks & Community Services Standard Detail Drawings

# Introduction

---

This manual was written to provide clear direction on standard operational procedures and design features to effectively communicate the operational practices of the Parks & Community Services Department to the public and to respond to regional, state and federal environmental issues. Proper care and maintenance, as well as the understanding of certain practices and systems, is essential in perpetuating the longevity and usefulness of our park resources.

The Parks & Community Services Department's mission is to contribute to a healthy community through an integrated system of exceptional parks, open space, recreational, cultural and human services. This mission is based on the Parks and Community Services Department's philosophy to:

- Protect and preserve environmentally sensitive natural areas;
- Provide connections for an integrated open space system;
- Enhance the city's visual character throughout the park system by perpetuating the "City in a Park" ideal;
- To acquire and develop park facilities to meet the present and future needs of the community; and
- To renovate or modify parks for optimum use of resources.

The goals of the Parks & Community Services Department are to ensure the safety of citizens, protect water quality, provide for recreation, preserve wildlife habitat, buffer land uses and improve landscape conditions. All park designers, planners, managers, crews and contractors are required to use water efficiently, implement the principles of IPM, reduce and reuse landscape waste materials, minimize negative impacts on aquatic environments and soil organisms, design and renovate landscape areas to suit the site conditions, and restore, create and protect environmentally rich habitats.

The Parks & Community Services Department is the single largest landowner and manager in Bellevue, with over 2,700 acres of park and open space property. Within the system are 78 neighborhood and community parks with various amenities such as beaches, golf courses, sport-fields/courts, community centers and city buildings. Remaining open space consists primarily of natural areas comprised of forests, steep slopes, wetlands, riparian corridors and meadows. Parks & Community Services also manages 46 acres of farmland and approximately 200 acres of street tree and arterial landscapes within the city's developed right-of-ways.

In order to continue to improve the standard of care and our maintenance practices, the Parks & Community Services Department will review and revise this manual every 4 years. Any changes, modifications, or comments regarding these best management practices should be directed to the Natural Resource, Resource Management and Planning Divisions.

Sincerely,



Michael Shiosaki, Director  
Parks & Community Services Department

# How to Use This Manual

---

This manual represents present day ideals and should be seen as a flexible document that can readily adapt to new environmental information and management technologies. The wording of this manual has been carefully selected. “Shall” and “will” have been selected to indicate those activities that are performed as management practices. The verb “should” prescribes practices the Department should be performing to adequately care for the resources base.

In an effort to better organize this information, this manual has been divided into 11 chapters that collectively represent the breadth of the Parks & Community Services Department’s maintenance operational responsibilities. Each chapter has a consistent section format, as follows:

## **Section 1 – Purpose**

Discusses the inventory of the resource being managed and describes the level of detail known about the resource. It explains the objectives for which that specific resource is managed and the role it serves in the community. This section also presents any of the environmental risks associated with the management of that resource and the effect it has on air and water quality.

## **Section 2 – Background**

Provides background information about the resource, including design elements considered during creation, renovation or enhancement of the resource, and relevant policies.

## **Section 3 – BMPs**

Outlines the specific Best Management Practices (BMPs) associated with the resource. BMPs can be defined as a clear and consistent set of directions to Parks staff for the management and maintenance of resource areas and the individual assets contained within those areas. Resource areas within the City of Bellevue parklands include landscape, horticulture, urban forest, and agricultural categories. This section also includes safety and risk management procedures and equipment requirements, if applicable.

## **Section 4 – Training**

Notes training needed or required.

# CHAPTER 1 – Construction Site Management



## 1.1 Purpose

The purpose of this section is to identify the management practices that should be employed at construction sites to guarantee a successful project before, during and through a lifetime of site use and maintenance.

The Bellevue Parks & Community Services Department plans and manages construction sites to control development and renovation schedules, cost, quality, and to the extent feasible, preserve existing vegetation and infrastructure to:

- Ensure public safety and reduce liability.
- Sustain both the function and value of existing vegetation, by avoiding physical injury to existing trees and other vegetation, including subsurface damage, especially to the root systems.
- Sustain both the function and value of existing soils and hydraulic integrity of the entire site by employing strategies to reduce or avoid compaction and soil degradation by providing means and methods for working in critical areas, and root zones, when no feasible alternative is available.
- Provide temporary, new and/or protect existing infrastructure such as irrigation, utilities and underground drainage to ensure value and function.
- Prevent sediment laden and/or polluted runoff from entering drainage systems and water bodies (streams, wetlands, lakes).

- Protect habitat for animals and wildlife, and limit to the extent possible, loss of habitat and ecosystems
- Minimize costs associated with site restoration.

### 1.2 Background

Many problems encountered in landscape maintenance can be traced to poor planning, construction or management. Planning, including schedule of the work, site access, construction staging, site protection, material quality and construction practices can all inform the success, or not, of a projects landscape. If access is not adequately planned, or if during construction, equipment accidentally strikes or grades over vegetation, those plants often suffer or die. If a site's soil is overly compacted or contaminated, it will not allow the air and water movement essential for healthy root zones and plants. If hydrologic processes on site are disrupted, the site may forever have drainage problems. These and other construction related impacts can produce long-term maintenance problems that can be avoided by following the BMPs set forth in the remainder of this section.

### 1.3 Best Management Practices

#### **Pre-Construction – Design and Planning**

Design and planning are critical steps to every successful construction project. The project manager shall ensure that project construction documentation adequately captures and communicates project parameters. Development of construction plans should begin with an understanding of the site including previous development and existing conditions. This shall include consultation with site manager(s) to confirm understanding of the sites built and natural system functions.

Construction scope, impacts, regulatory requirements, scheduling and funding shall be established prior to initiating construction.

- Construction documents shall be created to the degree necessary to communicate project objectives and requirements.
- The site shall be inventoried and surveyed as necessary. Site inventory includes all aspects of the built and natural environment. As appropriate to the project, features can include: topography, wetlands, streams, construction access and staging, trees (size, species, and number) irrigation and drainage systems; site restrictions and legal requirements (e.g. easements); and problems, if any, of root intrusions into the drainage and other utility systems.

- Construction documents should convey what is to be protected, demolished, and constructed. They should communicate the limits of work area, the work, access and staging, safety, drainage and erosion control plans. Documents may include but are not limited to: survey, TESC, civil, building, electrical, planting and irrigation plan sheets.
- All trees and plants to be removed or preserved and protected shall be identified on plans.
- The project manager and other appropriate park staff shall review plans for quality control purposes prior to submission for permitting and construction.

## Permitting

The project manager is responsible for securing all necessary permits for each construction project. The project manager will coordinate work to ensure permit requirements are met, maintained, monitored, reported and removed per regulatory direction (City, State, Federal per DSD, DAHP, DOE etc.).

- Regulatory plans and turbidity monitoring requirements shall be understood and established prior to construction. This includes National Pollutant Discharge Elimination System (NPDES) requirements for erosion control. Specific requirements of NPDES are covered in Chapter 2 – Stormwater Pollution Protection Plan (SWPPP) for Park Operations.
- The project manager shall know and understand the development and building regulations concerning project development including that for tree and vegetation in the area.
- The project manager will ensure that the "Dial-Before-You-Dig" (1-800-424-5555 or 811) to locate any underground utilities onsite occurs before construction begins.

## Construction Site Preparation / Landscape BMP

Prior to the initiation of onsite construction, the project manager shall establish communication protocol and reporting to ensure ongoing understanding and compliance with permit requirements, scope of the work, changes in work, schedule and Best Management Practices (BMPs). The project manager is responsible for ensuring compliance with BMPs throughout construction. These BMPs at a minimum shall include:



- Planned Site Temporary Erosion and Sediment Control (TESC) systems are in place and include protection of critical areas and associated buffers, for wetlands, streams and steep slopes.
- Site access and staging areas are established and fenced with chain link or construction fencing to ensure public safety and protect existing trees, plants and their roots. Utility access corridors should be avoided.
- Tree and vegetation protection is in place per plan. Six foot (6') high chain-link fencing, or other approved tree protection fencing, is installed around the tree protection zone (TPZ) and any other vegetation that is to remain onsite. At the discretion of the project manager, the fencing shall be installed at least 1 foot out from the trunk for every inch diameter of the existing trees or farther.
  - If tree protection cannot be installed at the predetermined TPZ because of site constraints, the fencing can be moved no closer than the critical root zone (CRZ) and an adequate root buffer shall be constructed in the affected area of the TPZ.
- Trees and plants in the construction zone have been pruned as necessary to remove deadwood and prevent damage from construction equipment.
  - For alterations to designated tree protection, especially for any root impacts and pruning exercises, a certified arborist should be consulted and BMP followed as noted below.
- Trees/plants to be preserved have been watered and fertilized before and after construction at the discretion of the project manager.
- Irrigation and drainage systems are protected from damage unless plans call for the demolition or renovation of such systems.

### **Construction / Landscape BMP**

The project manager shall regularly monitor construction to ensure ongoing compliance with specifications and BMPs. Unforeseen circumstances and subsequent construction changes are inevitable. It is the project manager's responsibility to manage that change, and ensure those changes comply with BMPs, permitting regulations, and city policies.

The following tree protection BMPs are intended to eliminate undesirable consequences that result from uninformed or careless acts and to preserve both trees and property values. Trees vary in their ability to adapt to altered growing conditions. Mature trees have established stable biological systems in the pre-existing physical environment. Disruption of this environment by construction

activities interrupts the tree's physiological processes causing depletion of energy reserves and a decline in vigor, often resulting in the tree's death. Typically, this reaction may develop from one to seven years after disruption.

The project manager shall stop work if construction site management BMPs are not being maintained by the contractor. The project manager is responsible for approving, or not, unanticipated vegetation removal during construction. The following BMPs, if followed, will reduce the negative impacts of park construction on trees:

- Tree protection fencing shall be placed at the outer limit of the TPZ. If the fencing must enter inside the TPZ, a root buffer will be constructed. One warning sign will be displayed for every 15 feet of lineal fencing, facing toward the work area.
  - Trenching and excavation activities are prohibited within the TPZ.
  - No activity is allowed in the CRZ of the trees being protected.
- On occasion, trees will need to have branches pruned in order to facilitate access to a construction site or the construction of a new facility. Pruning will follow International Society of Arboriculture Pruning Guidelines.
- When utility installation must occur within the TPZ, tunneling shall be the preferred method to install such utilities. The tunnel shall be dug either by hand, air spade, hydraulic vacuum or mechanical tunnel boring under the roots with horizontal directional drill and hydraulic or pneumatic air excavation technology.
- Cement washout pits and chemical holding areas shall be located away from vegetation protection areas, streams and wetlands.
- Contractor parking and material storage shall be limited to already impacted areas away from tree roots.
- To the extent possible, construction equipment shall be kept away from all onsite vegetation, especially those within designated protection areas. Site offices and equipment shall not encroach into vegetation protection areas.
- Whenever possible, control and minimize grade changes within vegetation protection areas. Generally, no changes in grade should occur within the TPZ of any tree to remain on site. This area may be increased at the discretion of the project manager. If the grade must be raised around a desired tree, a dry well shall be constructed around the tree at the drip line or some point farther out.

- Refueling and maintenance areas shall be kept away from trees, native soils, water bodies and drainage systems. Fuel spills will not be tolerated on construction sites. If pollutants leak or are discharged into a waterbody or into the stormwater system, the City of Bellevue Clearing and Grading Inspector and Utilities Department Water Quality Division shall be contacted.
- TESC implementation, maintenance, turbidity monitoring and removal shall follow City and State regulations.

### **Post-Construction / Landscape Maintenance**

Maintaining preserved and establishing new vegetation is the primary focus following construction. This requires identifying problems and treatments that may help preserve these resources. If warranted, severely damaged vegetation should be removed and replaced by the contractor at their expense with new plantings, per warranty. The following practices should be employed to preserve vegetation:

- Weekly water management is most important. At least one inch (1") per week between May 1<sup>st</sup> – Sept. 30<sup>th</sup>, corresponding with drier weather.
- Insure contractor compliance with plant maintenance and establishment warranty period per contract specifications.
- Fertilize with an appropriate product, as needed.
- Wait one growing season for pruning and use minimal nitrogen fertilizer applications. Maintain levels for 3 to 5 years.
- Maintain a depth of 2 to 3 inches of mulch around trees and shrubs, and new plantings.
- Watch closely for pests and changes in plant structure. Preventative treatments may be advisable.
- Maintenance staff shall closely monitor and inspect all new construction throughout the warranty period to ensure plant establishment.
- Special emphasis will be placed on weed control during the plant establishment period (3 to 5 years).
- For enhancement projects completed within Sensitive/Critical Areas or Sensitive/Critical Area Buffers, the project manager shall coordinate all monitoring protocol as established and enforced by the Bellevue Developmental Services Division. Specific information concerning Sensitive/Critical Area management is covered in Chapter 9 – Trees and Natural Areas.

## Mitigating Tree Infrastructure Conflicts

Conflicts may occur when tree roots grow adjacent to paving, foundations, sidewalks or curbs (hardscape). Improper or careless extraction of these elements can cause severe injury to the roots and instability or even death of the trees. The following alternatives must first be considered before root pruning within the TPZ of a tree.

### 1. Removal of Pavement or Sidewalk

Removal of existing pavement over tree roots shall include the following precautions:

- Break hardscape into manageable pieces with a jackhammer or pick and hand load the pieces onto a loader. The loader must remain outside the TPZ on undisturbed pavement or off exposed roots. Do not remove base rock that has been exploited by established absorbing roots.
- Apply untreated wood chips over the exposed area within one hour, then wet the chips and base rock and keep moist until overlay surface is applied.

### 2. Replacement of pavement or sidewalk

An alternative to the severance of roots greater than 2- inches in diameter should be considered before cutting roots. If an alternative is not feasible, remove the sidewalk, as stated above, cut roots with a sharp, clean saw, as approved by the project manager or arborist, and replace sidewalk using #3 dowels at the expansion joint if within 10-feet of a street tree. Use wire mesh reinforcement if within 10-feet of the trunk of a tree.

### 3. Alternative methods to prevent root cutting

- Grinding a raised sidewalk edge.
- Ramping the walking surface over the roots or lifted slab with pliable paving. Routing the sidewalk around the tree roots.
- Install boardwalk, flexible paving or rubberized sections.

### 4. Alternatives to conventional pavement and sidewalk materials

Substitute permeable materials for typical asphalt or concrete overlay, sub-base, or footings to consider are:

- Permeable paving materials (such as ECO-Stone or RIMA pavers).
- Interlocking pavers, flexible paving, wooden walkways and brick or flagstone walkways on sand foundations.

## 5. Tree and Infrastructure Conflicts

Avoid tree and infrastructure conflicts and associated costs by the following planting practices:

- Plant deep rooting trees that are proven to be non-invasive.
- Over soil that shrinks and swells, install a sidewalk with higher strength that has wire mesh and/or expansion slip joint dowel reinforcement.
- Fracture soil with an air spade and backfill with sand prior to planting to promote deep rooting and improved drainage.
- Install root barrier only along the hardscape area of the tree and allow roots to use open lawn or planter strip areas.
- Dedicate at least 10-linear feet of planting space for the growth of each tree.
- Provide a dedicated irrigation system or zone for the tree so the trees do not have to compete and are not dependent on the turf and shrub irrigation.
- Avoid planting trees over underground drainage systems where root intrusion will impede function of the system.
- Consider the use of a soil cell system under hard surfaces to provide adequate volume for healthy root development.

## 6. Alternative Base Course Materials

When designing hardscape areas near trees, the project architect or engineer should consider the use of recommended base course material such as an engineered structural soil mix. An approved structural soil mix will allow a long-term, cost-effective tree and infrastructure compatibility that is particularly suited for the following types of development projects:

- Repair or replacement of sidewalk greater than 40-feet in length.
- Planting areas that are designed over structures or parking garages.
- Confined parking lot medians and islands or other specialized conditions as warranted.

## 7. Tree Removal

In some cases, tree removal may be the preferred option if the site does not provide adequate space to account for future growth of the tree.

## 1.4 Training

Provide training to all construction personnel to make sure they understand all construction site BMPs.

- The project manager and the designated site manager(s) shall receive the most recent training and education dealing with construction site management. This training includes the most recent advances for protecting trees and erosion control on construction sites.
- Urban Foresters and site managers should receive training in appraising and evaluating tree and plant damage according to International Society for Arboriculture standards.

(This page intentionally left blank)

# CHAPTER 2 – Stormwater Pollution Prevention Plan (SWPPP) for Park Operations

---



---

## 2.1 Purpose

Bordered by Lake Washington & Lake Sammamish, the City of Bellevue has more than 60 miles of streams, 800 acres of wetlands and 3 small lakes (Larson, Phantom, and Bellevue) that provide rich habitat for fish and wildlife as well as a multitude of benefits that enhance the quality of life for Bellevue residents. Protecting these environmentally sensitive assets from the discharge of harmful pollutants is an important goal of the Parks & Community Services Department.

Stormwater accumulates a variety of pollutants as it runs over roofs, lawns, sidewalks, streets, compacted soils and parking lots before entering streams or groundwater. Pollutants commonly found in urban stormwater include heavy metals, pesticides and fertilizers, oil and grease, bacteria and sediment. Stormwater runoff contributes to water quality problems that can endanger human health and wildlife.

Bellevue Parks & Community Services operates three maintenance facilities (Resource Management, Bellefields and Golf Course) that have areas where bulk materials are stored and equipment is washed. Bulk materials are also intermittently stored on a temporary basis at park and open space sites when performing maintenance and renovation operations such as turf topdressing, infield replenishment, trail resurfacing and landscape renovation. In addition, the Parks



Department manages multiple off leash dog facilities where biowaste is produced and routinely washes equipment, buildings, docks, picnic shelters, playgrounds and hard surfaces at various park sites throughout the city. If not properly managed, pollutants can be discharged from these facilities or sites into the city's stormwater system. The purpose of this section is to identify methods and procedures to reduce or eliminate the contamination of stormwater runoff or discharges of pollutants from Bellevue Parks operations. The objectives of a Stormwater Pollution Prevention Plan (SWPPP) are as follows:

- Implement and maintain best management practices that identify, reduce, eliminate and/or prevent the discharge of stormwater pollutants from maintenance facilities and operations.
- Eliminate unpermitted discharges and other illicit discharges into the city's stormwater drainage systems.

## 2.2 Background

The Washington State Department of Ecology (DOE) requires that the city meet the requirements of the NPDES and State Waste Discharge General Permit and Phase II Municipal Stormwater Permit. Conditions of this permit require that the city implement and maintain a SWPPP for all heavy equipment maintenance or storage yards, and all material storage facilities owned or operated by the city. The permit also requires the city to include periodic visual observation of discharges from the facility to evaluate the effectiveness of the BMPs. The Resource Management, Bellefields and Golf Course maintenance facilities are included in the SWPPP since activities at these three sites can be categorized as heavy equipment maintenance or storage yards or bulk material storage facilities.

The Stormwater Management Manual for Western Washington establishes source control BMPs for various construction, renovation and maintenance tasks to help businesses and municipal agencies comply with the requirements of the NPDES general permit. Relevant source control BMPs applicable to Bellevue Parks operations will also be covered in this chapter.

## 2.3 Best Management Practices

### Park Operational Facilities

#### Good Housekeeping

“Good housekeeping” is an ongoing approach to improving and maintaining a clean and orderly work environment. Recommendations for good housekeeping are as follows:

- Promptly contain and clean up solid and liquid pollutant leaks and spills including oils, solvents, fuels and dust to prevent contact with any soil, vegetation or paved area exposed to stormwater.
- Sweep paved material handling and storage areas regularly as needed to collect and dispose of dust and debris that could contaminate stormwater. Do not hose down pollutants from any area to the ground, storm drain, conveyance ditch or receiving water unless necessary for dust control purposes to meet air quality regulations and unless the pollutants are conveyed to a treatment system approved by the city.
- Clean accumulations of oils, debris, sludge, etc. from all BMP systems regularly, including catch basins, sedimentation basins, oil/water separators, boomed areas and conveyance systems to prevent the contamination of stormwater.
- Promptly repair or replace all substantially cracked or otherwise damaged paved secondary containment, high-intensity parking, and any other drainage areas, which are subjected to pollutant material leaks or spills.
- Promptly repair or replace all leaking connections, pipes, hoses, valves, etc. which can contaminate stormwater.
- Use solid absorbents and rags for cleanup of liquid spills and leaks where practical.
- Dispose all green waste in appropriate storage bins for regular recycling and disposal. All non-green waste and construction debris should be separated and disposed of separately. Contaminated green waste generated from street and parking lot sweeping should be handled separately and transferred to an appropriate vendor who can accept contaminated waste.

#### Perform Routine Maintenance

Over time, sediment and pollutants can accumulate in stormwater collection, conveyance, and treatment systems, such as basins, ditches, storm drains and oil/water separators. These pollutants can include sediment and other substances

such as oils, debris and sludge. When a storm event occurs, the pollutants can become mobilized and transported into receiving waters. Regular maintenance of the stormwater drainage system decreases the amount of pollutants available to contaminate stormwater. Routine maintenance elements and recommendations are described as follows:

1. Catch Basins. Catch basins at the Resource Management, Bellefields, and Golf Course facilities shall be inspected annually and maintained according to maintenance standards consistent with the most recent edition of the Stormwater Management Manual for Western Washington. Additional inspections may be warranted following major storm events (e.g. greater than 1 inch of precipitation in a 24-hour period).
2. Parking Lot Sweeping. Sweeping should occur monthly to reduce the amount of potential sediment entering storm catch basins and conveyance systems. This practice will help reduce the costs associated with commercial cleaning and repairs identified through the NPDES Utility inspection program.
3. Stormwater Treatment Facilities. The Resource Management & Golf Course facilities have equipment wash stations that treat stormwater through oil/water separators before discharging into the city's storm conveyance system. These treatment facilities shall be inspected annually and maintained using standards consistent with the most recent edition of the Stormwater Management Manual for Western Washington. The separators shall be vacuum cleaned throughout the year as necessary.
4. Drainage Systems/Ponds. Inspection and maintenance of drainage conveyance systems and retention ponds should occur annually. Cleaning of inflow and outflow drains (e.g. removing built up vegetation) should be performed annually. These practices will extend the service life of the system and reduce long-term maintenance costs.

### **Spill Prevention & Response**

Spills can contribute a variety of pollutants to the stormwater drainage system and nearby waterways, but this result is often preventable if appropriate practices for chemical and waste handling and spill response are implemented.

1. Spill Prevention. To reduce the potential for spills, the following practices shall be implemented:
  - Clearly label all containers that contain potential pollutants.
  - Store and transport liquid materials in appropriate containers with tight fitting lids.
  - Place drip pans underneath containers, fittings, valves and any other area where materials are likely to spill or leak.

- Use tarpaulins, ground cloths or drip pans in areas where materials are mixed, carried and applied to capture any spilled materials.
2. Spill Plan. The Resource Management, Bellefields, and Golf course facilities shall implement site specific spill plans to address small spills and leaks. These plans shall be updated annually and posted at appropriate points in the building, such as loading areas, product storage areas and waste storage areas. The spill plan shall include the following information:
    - Facility description including the address and telephone number, the nature of the facility and the general types of chemicals used.
    - Names, addresses and telephone numbers of designated spill response employees who are responsible for implementing the spill cleanup.
    - Site drainage plan showing locations of storage areas for chemicals, storm drains and other relevant drainage or materials information.
    - Description of the emergency cleanup and disposal procedures.
    - Names and telephone numbers of agencies to contact in the event of a spill.
  3. Spill Cleanup Kits. Spill cleanup kits shall be stored near areas with a high potential for spills so that they are easily accessible. The spill kit contents must be appropriate to the types and quantities of materials stored or otherwise used at the facility and refilled when materials are used. Spill kits may include the following items:
    - Absorbent pads
    - Sorbent booms
    - Absorbent granular material (e.g. kitty litter)
    - Personal protective equipment (e.g. latex gloves, safety goggles)
    - Thick plastic garbage bags
    - Drain cover
  4. Spill Cleanup & Disposal. To minimize release of pollutants into the storm drainage system, the following procedures shall be implemented when there is a spill:
    - Immediately report spills that involve potentially flammable or hazardous substances to the Bellevue Fire Department. Notify the Utilities 24-hour Emergency Response Line (425-452-7840) that an illicit discharge has occurred.
    - Immediately evaluate whether the illicit discharge can be safely contained or prevented from entering the drainage system and/or receiving waters.

- Determine the responsible party, if possible.
- Characterize the nature of the pollutant so that the appropriate personal protective equipment (PPE) can be utilized.
- If you know what the substance is, follow the recommended procedures for containment/cleanup for that substance. If necessary, refer to the material safety data sheet (MSDS) for the substance.
- If the substance is unknown, the following steps shall be taken:
  - If it is safe to do so, attempt to contain the spill. Use physical barriers, such as sandbags, or an absorbent, such as a pad or clay litter.
  - Do not use water or any other substances on the spill unless it is safe to do so.
  - Do not wash or push the substance toward the drain, indoors or out, until it has been identified and a safe cleanup method has been determined.
  - Immediately notify your supervisor of the spill and what steps have been taken to contain it or identify the substance.
- If necessary, place warning signs or barriers around the area to keep people away.
- Do not use a vacuum to clean up flammable substances.

### **Maintenance Facility Inspections**

The Resource Management, Bellefields, and Golf Course maintenance facilities shall be regularly inspected by the designated SWPPP manager where heavy equipment and material storage areas are exposed to stormwater. During these inspections, staff shall assess how the stormwater BMPs are operating. Routine visual inspections shall occur at least quarterly during the wet season (October – March) and at least once during the dry season. Some types of equipment, processes and BMPs will require more frequent checks than others. Visual inspections of wash stations should occur monthly with a written log maintained each year of the person who made the inspection, the date of the inspection and what action was taken as a result of the inspection. Removal and clearing debris from the separators should occur immediately after each inspection as required.

### **Park & Open Space Inspections**

The Bellevue Utilities Department annually inspects all managed park and open space sites that contain stormwater systems and detention facilities. Upon completion of these inspections, detailed reports and maps are provided to the Parks Department and correction notices are issued for any systems that are out of

compliance with NPDES standards. Upon receiving these notices, the Parks Department shall initiate appropriate actions to correct any stormwater infrastructure that is out of compliance. Such actions may include sediment extraction from catch basins and stormwater lines, replacement of filtration equipment and repair or installation of erosion control devices. In general, all required corrective measures should be completed within 3 months of notification.

### **Reporting & Record Keeping**

Records shall be kept of all inspections, observations and compliance documentation for each of the Resource Management, Bellefields, and Golf Course facilities as well as inspections of park and open space sites. The results of each visual inspection shall be summarized in an inspection report or checklist and be entered into the city's Maximo database. The visual inspection report shall include the following:

- Scope of the inspection and date.
- Major observations relating to the implementation of the SWPPP.
- Summary of the actions which will be taken to meet NPDES Municipal Stormwater permit requirements.
- Tracking procedures to ensure that an inspection report is prepared, and appropriate corrective actions taken.

### **Construction Site Management**

The construction or refurbishment of park facilities can include demolition work, site grading, import/export of materials, concrete and asphalt work, erection and/or renovation of buildings and playgrounds, installation of fencing, drainage improvements and the installation of irrigation and landscaping as well as many other activities. If not managed properly, these activities can lead to the discharge of sediments and other contaminants into the stormwater system and/or receiving waters.

The City of Bellevue Developmental Services Department is the lead regulatory authority for construction activity in Bellevue and provides a comprehensive list of associated BMPs on the City of Bellevue website.

### **Building Construction and Renovation**

Pollutants of concern include toxic hydrocarbons, hazardous waste, toxic organics, suspended solids, heavy metals, pH, oils and greases. The goal is to control leaks, spills and loose material. Utilize good housekeeping practices and regularly clean up debris that can contaminate stormwater. Protect the drainage system from dirty runoff and loose particles.

- Identify and properly remove hazardous substances from the building prior to beginning renovation activities, such as PCB's, asbestos, lead paint, mercury switches and electronic waste.
- Educate employees about the need to control site activities to prevent stormwater pollution and train them in spill cleanup procedures.
- At all times, have spill cleanup materials appropriate to the chemicals used on site.
- Clean up the work site at the end of each workday. Put away materials (such as solvents) indoors or cover and secure them so that unauthorized personnel will not have access to them.
- Sweep the area daily to collect loose litter, paint chips, grit and dirt.
- Do not dump any substance on pavement, on the ground, in the storm drain, or toward the storm drain, regardless of its content, unless it is clean water only.
- Place a drop cloth, where space and access permits, before beginning wood treating activities. Use drip pans in areas where drips are likely to occur if the area cannot be protected with a drop cloth.
- Use ground or drop cloths underneath scraping and sandblasting work. Use ground cloths, buckets or tubs anywhere that work materials are laid down.

### **Cleaning Buildings, Structures and Equipment**

Exterior cleaning activities conducted at community centers, visitor centers, restrooms, picnic shelters, playgrounds, water spray parks, skate parks, sport courts and surrounding areas where hand scrubbing and pressure washing is involved may release pollutants such as heavy metals, suspended solids, grit and paint chips into the stormwater system. Such cleaning activities may include the washing of siding, awnings, roofs, HVAC equipment, sidewalks, parking lots, retaining walls, picnic tables, benches, signs, fences and garbage cans.

#### **Buildings and Structures**

- When feasible, use dry scrubbing or scraping methods to remove loose debris, such as flaking paint, to prepare areas for wet washing. Sweep up or vacuum the debris and remove it from the site prior to introducing water and detergents.
- When using hot water and/or detergents, wastewater shall be discharged to the sanitary sewer system. Using tarps with berms and a wet/dry vacuum can be an effective way to capture wastewater.

- If only using cold water with no detergents, and runoff does not contain pollutants, wastewater may be allowed to drain into surrounding turf/landscaped areas or the stormwater system.
- Wastewater from cleaning rooftops and rooftop equipment, such as exhaust fans and HVAC equipment, shall be captured and discharged to the sanitary sewer system. The use of wet/dry vacuums, temporary berms or containers can be an effective way to capture wastewater on rooftops.

### **Parking Lots, Driveways, Pathways and Sidewalks**

- Sweep, shovel or scrape up large debris and remove it from the site prior to washing.
- When possible, use a street sweeper service to clean driveways and parking lots.
- When using hot water and/or detergents, the wastewater shall be captured and discharged into the sanitary sewer system.
- If only using cold water with no detergents, and runoff does not contain pollutants, wastewater may be allowed to drain into surrounding turf/landscaped areas. Wastewater may also be allowed to drain into the stormwater system if an approved sediment removal device is used, such as a filter sock installed within a catch basin.

### **Graffiti Removal**

- Wastewater generated from graffiti removal shall be captured and discharged to the sanitary sewer system.
- If removing graffiti with a cleaner only, apply sufficient cleaner to do the job and wipe clean without the use of water. This will prevent the discharge of cleaning products into the stormwater system.

### **Painting Buildings, Structures and Equipment**

Surface preparation and the application of paints, finishes and/or coatings to buildings, structures and equipment outdoors can be sources of pollutants. Potential pollutants include organic compounds, oils and greases, heavy metals and suspended solids. Good housekeeping and maintenance practices will prevent the discharge of sanding grit and paint overspray into the stormwater system.

- Train employees in the careful application of paints, finishes and coatings to reduce misuse and overspray. Use drop cloths underneath outdoor painting, scraping, and sandblasting work, and properly clean and temporarily store collected debris daily.
- Do not conduct spraying, blasting or sanding activities over open water or where wind may blow paint into water.



- Wipe up spills with rags and other absorbent materials immediately. Do not hose down the area to a stormwater system, receiving water, or conveyance ditch.
- On dock areas, sweep rather than hose down debris. Collect any hose water generated and discharge to the sanitary sewer system or transport to an appropriate disposal facility.
- Use a catch basin cover, filter sock or other effective runoff control device if dust, grit, wash water or other pollutants may escape the work area and enter a catch basin. The containment device(s) shall be in place at the beginning of the workday. Collect contaminated runoff and solids and properly dispose of such wastes before removing the containment device(s) at the end of the workday.
- Use a ground cloth, pail, drum, drip pan, tarpaulin or other protective device for activities such as outdoor paint mixing and tool cleaning, or where spills can contaminate stormwater.
- Properly dispose of all waste and prevent all uncontrolled releases to the air, ground or water.
- Clean paintbrushes and tools covered with water-based paints in sinks connected to the sanitary sewer system. Do not dump pollutants collected in portable containers into stormwater drains.
- Clean brushes and tools covered with non-water-based paints, finishes or other materials in a manner that allows collection of used solvents (e.g. paint thinner, turpentine, xylol) for recycling or proper disposal.
- Store toxic materials under cover (tarp, etc.) during precipitation events and when not in use to prevent contact with stormwater.

## **Dock Washing**

Washing docks (or wharves, piers, floats and boat ramps) can result in the discharge of dirt, bird feces, soaps and detergents that can be toxic to aquatic life, especially after they take on contaminants while cleaning. Use dry methods and equipment (scraping, sweeping, vacuuming) to remove debris and contaminants prior to cleaning with water to prevent these substances from entering surface water.

## **Surface Preparation and Spot Cleaning**

- Scoop and collect debris and bird feces.
- Sweep, capture and dispose of debris from the dock as solid waste. Sweep or vacuum docks to minimize the need for chemical cleaners.
- During cleaning activities, if debris, substances, or wash water could enter surface waters through drains, temporarily block the drains and collect the water for proper disposal.

- Hose down the area if necessary and collect water as feasible.
- Try spot cleaning with water and a coarse cloth before using soaps or detergents.
- If a cleaner is needed for spot cleaning:
  - Mix it in a bucket and use it to scrub down only the areas that need extra attention.
  - Start with vinegar and baking soda and move to other options as needed. Spot clean using a rag if harsher cleaning products are needed.
  - Avoid or minimize the use of petroleum distillates, chlorinated solvents and ammoniated cleaning agents.
  - Use degreasers or absorbent material to remove residual grease by hand and do not allow this material to enter surface water.
  - Keep cleaners in sealed containers. Keep cleaner containers closed securely when transporting between the shore and docks.
  - Properly dispose of the dirty bucket water.
- Minimize the scour impact of wash water on any exposed soil at the landward end(s) of the dock or below the dock. Place a tarp over exposed soil, plant vegetation or put berms to contain eroded soil.

### **Washing and Disposal**

- To the extent practicable, collect any wash water generated from hosing down, pressure washing, or cleaning dock areas, and dispose of it properly.
- Try pressure washing using light pressure. This uses less water and decreases the need for soap and scrubbing when washing the dock. Avoid using excessive pressure, which may damage the dock or send flakes of paint and other material into the water.
- Do not place any debris and substances resulting from cleaning activities in shoreline areas, riparian areas or on adjacent land where these substances may erode into receiving waters.
- Where treated wood associated with the structure being washed are present, use non-abrasive methods and tools that, to the maximum extent practical, minimize removal of the creosote or treated wood fibers when it removes marine growth from creosote or any other treated wood.
- Do not discharge removed marine growth to receiving waters where such marine growth would accumulate.

## Landscaping and Turf/Vegetation Management

Landscaping can include grading, soil transfer, vegetation planting and vegetation removal. Examples include weed control on formal lawns, athletic fields, landscape beds, access roads, parking lots and trails. Proper management of vegetation can minimize excess nutrients and pesticides. The objective shall be to maintain appropriate vegetation to control erosion and the discharge of pollutants into the stormwater system. Where practical, grow plant species appropriate for the site, or adjust the soil properties of the site to grow desired plant species.

- When feasible and practical, install engineered soil/landscape systems to improve the infiltration and regulation of stormwater in landscaped areas.
- Select the right plants for the planting location based on proposed use, available maintenance, soil conditions, sun exposure, water availability, height, sight factors and space available.
- Do not dispose of collected vegetation into waterways or sewer systems.
- Do not blow vegetation or other debris into the drainage system.
- Dispose of collected vegetation such as grass clippings, leaves and branches by composting or recycling.
- Use manual and/or mechanical methods of controlling undesirable vegetation rather than applying herbicides, where practical.
- Use at least an eight-inch "topsoil" layer with at least 8 percent organic matter to provide a sufficient growing medium.
- Select the appropriate turfgrass mixture for the climate and soil type.
- Conduct mulch-mowing whenever practical.
- Use native plants in landscaping.
- Use mulch or other erosion control measures on soils exposed for more than one week during the dry season (May 1 to September 30) or two days during the rainy season (October 1 to April 30).
- When feasible, till a topsoil mix or composted organic material into the soil to create a well-mixed transition layer that encourages deeper root systems and drought-resistant plants.
- When practical, apply an annual topdressing application of 3/8" compost which will enhance soil permeability, provide nutrients to keep trees and shrubs healthy, and will reduce demand for fertilizers and pesticides.
- Disinfect gardening tools after pruning diseased plants to prevent the spread of disease.
- Prune trees and shrubs in a manner appropriate for each species.
- If specific plants have a high mortality rate, assess the cause and replace with another more appropriate species.

- Overseed bare turf areas until the vegetation fully covers the ground surface.
- Plant and protect trees.
- Aerate lawns regularly in areas of heavy use where the soil tends to become compacted.
- Set the mowing height at the highest acceptable level and mow at times and intervals designed to minimize stress on the turf.

## Nurseries and Greenhouses

Common practices at nurseries and greenhouses can cause elevated levels of phosphorus, nitrogen, sediment, bacteria and organic material which can contribute to the degradation of water quality. The objective is to minimize the pollutants that leave the site by controlling the placement of materials, stabilizing the site and managing irrigation water.

- Establish composting areas, soil storage bins and mixing areas at least 100 feet away from any stream or body of water and as far away as possible from any onsite stormwater system.
- Do not dispose of collected vegetation into waterways or storm sewer systems. Do not blow, sweep, or otherwise allow vegetation or other debris into the drainage system.
- Regularly clean up spilled potting soil to prevent its movement, especially if fertilizers and pesticides are incorporated.
- Use soil mixing and layering techniques with composted organic material to reduce herbicide use and watering.
- Cover soil storage and compost storage piles.
- Dispose of pathogen-laced potting substrate and diseased plants appropriately.
- Place plants on gravel, geotextile or weed cloth to allow infiltration and minimize erosion, including inside greenhouse structures.
- Properly reuse, recycle or dispose of used polyfilm, containers, and other plastic-based products so that they do not collect stormwater.
- Evaluate and manage irrigation to reduce runoff, sediment transport and erosion.
- Surround soil storage and compost storage areas with a berm or wattles.
- In areas with a large amount of foot traffic, use appropriate aggregate such as rock and gravel for stabilization.

## **Irrigation**

Irrigation consists of discharges from irrigation water lines, landscape irrigation and lawn or athletic field watering. Excessive watering can lead to discharges of chlorinated potable water runoff into drainage systems and erosion. Improper irrigation can encourage pest problems, leach nutrients and make a lawn completely dependent on artificial watering. The objective is to limit the amount and location of watering to prevent runoff and discharges into surrounding drainage systems.

- Irrigate with the minimum amount of water needed. Never water at rates that exceed the infiltration rate of the soil.
- Maintain all irrigation systems so that irrigation water is applied evenly and where it is needed.
- Ensure irrigation heads do not overspray vegetated areas resulting in excess water discharging into the drainage system.
- Inspect irrigated areas for excess watering. Adjust watering times and schedules to ensure that the appropriate amount of water is being used to minimize runoff. Consider factors such as soil structure, grade, time of year and type of plant material in determining the proper amounts of water for a specific area.
- Inspect irrigated areas regularly for signs of erosion and/or discharge.
- Place irrigation heads appropriately so that water is not being sprayed on impervious surfaces instead of vegetation.
- Repair broken or leaking irrigation head nozzles as soon as possible.
- Appropriately irrigate turf and landscaped areas based on the species planted, the available water holding capacity of the soil and the efficiency of the irrigation system.
- Do not irrigate plants during or immediately after fertilizer application. The longer the period between fertilizer application and irrigation, the less fertilizer runoff occurs.
- Do not irrigate plants during or immediately after pesticide application (unless the pesticide label directs such timing).
- For additional irrigation BMPs, see Chapter 4 – Irrigation and Water Management.

## **Fertilizer Application**

Poor application of fertilizers can cause appreciable stormwater contamination. Fertilizers can leach phosphorus and nitrogen which can contribute to algae blooms, increased nutrient concentrations and depletion of oxygen in receiving waters. The goal should be to minimize the amount of fertilizer necessary to maintain vegetation

and control the application of fertilizer to prevent the discharge of stormwater pollution.

- Apply the minimum amount of slow-release fertilizer necessary to achieve successful plant and turf establishment.
- Do not fertilize when the soil is dry or during a drought.
- Avoid applying fertilizers if it is raining or about to rain.
- Do not apply fertilizers within three days prior to forecasted rainfall. The longer the period between fertilizer application and either rainfall or irrigation, the less fertilizer runoff occurs.
- Determine the proper fertilizer application for the types of soil and vegetation involved.
- Follow manufacturers' recommendations and labeled directions.
- Train employees on the proper use and application of fertilizers.
- Keep fertilizer granules off impervious surfaces. Clean up any spills immediately. Do not hose down to a storm drain, conveyance ditch or water body.
- Do not fertilize areas within 50 feet of water bodies including wetlands, ponds and streams.
- Use slow-release fertilizers such as methylene urea, isobutylidene or resin coated fertilizers when appropriate.
- Apply fertilizers in amounts appropriate for the target vegetation and at the time of year that minimizes loss to surface and ground waters.
- Time the fertilizer application to periods of maximum plant uptake.
- Avoid using fertilizers that contain phosphorus.

## **Pesticides and Integrated Pest Management**

Pesticides include herbicides, rodenticides, insecticides, fungicides, etc. Examples of pesticide uses include:

- Weed control in parks, golf courses, access roads, utility corridors and streetscapes.
- Rooftop moss removal.
- Extermination of nuisance rodents.
- Fungicide application to golf greens.

It is possible to discharge pesticides such as pentachlorophenol, carbamates and organometallics into the environment from leaching and dripping of treated parts, container leaks, product misuse and outside storage of pesticide contaminated materials and equipment. Poor management of pesticides can cause appreciable stormwater contamination and unintended impacts to non-target organisms.

Relevant BMPs regarding the Parks Department's integrated pest management program, including pesticide storage, is covered extensively in Chapter 3 – Integrated Pest Management.

### **Farm and Animal Handling Areas**

The Kesley Creek Farm can potentially generate pollutants from manure deposits, animal washing, grazing and other handling activities that could potentially enter the surrounding Kelsey Creek basin if not managed properly. Pollutants can include coliform bacteria, nutrients and suspended solids.

- Regularly sweep and clean animal keeping areas to collect and properly dispose of droppings, uneaten food and other potential stormwater contaminants.
- Do not hose down areas that contain potential stormwater contaminants where they drain to storm drains or to receiving waters.
- Do not discharge any wash water to storm drains or to receiving waters without proper treatment.
- For uncovered and unpaved handling areas, the ground shall have either vegetative cover or some other type of ground cover such as straw, hog fuel or mulch.
- Surround the area where animals are kept with a fence or other means to prevent animals from moving away from the controlled area where BMPs are used.
- For outside surface areas that must be disinfected, use an unsaturated mop to spot clean the area. Do not allow wastewater runoff to enter the drainage system.
- Do not stockpile manure in areas where runoff is allowed to flow into a storm drain or to nearby receiving waters or wetlands.

### **Pet Waste Management**

The Parks Department manages multiple off leash dog facilities where biowaste is produced. If not managed properly, contaminants from pet waste can wash into the stormwater system and make its way into surrounding streams and lakes. Decay of pet waste can reduce oxygen levels and release ammonia into aquatic ecosystems. This combined with warm water can be toxic to aquatic wildlife. Pet waste also contains nutrients that encourage aquatic weed growth and contribute to low oxygen and high pH in waters used for swimming, boating and fishing. Most importantly, pet waste can carry viruses and bacteria that can be harmful to humans.

- Signs shall be posted notifying the public of the Parks & Community Services Facilities Code (BCC 3.43) which requires pet waste to be collected and deposited in an appropriate receptacle (BCC 3.43.140).
- Mutt Mitt® collection bags and waste receptacles shall be provided at all off leash dog facilities as well as areas within the park and open space system that are frequently used by dog owners.
- Signs, Mutt Mitt® collection bags and receptacles should be placed at locations that are clearly visible, accessible, and convenient to use.
- Mutt Mitt® dispensers shall be checked on a regular basis to ensure that they are always stocked.
- Waste receptacles shall be checked and emptied on a regular basis to ensure that they don't overflow. All pet waste shall be properly disposed of at approved solid waste collection center.
- The Park Ranger program shall provide education and incentives to encourage dog owners to pick up and dispose of pet waste properly.

## 2.4 Training

All staff members shall be trained annually on safe techniques for handling materials, spill control procedures and operations and maintenance of BMPs to prevent illicit discharge of pollutants into the city's stormwater system. All pollution prevention team members shall be trained annually in the operation, maintenance and inspections of BMPs. This training will be documented for compliance with NPDES Municipal Stormwater permit requirements.



(This page intentionally left blank)

## CHAPTER 3 – Integrated Pest Management (IPM)



### 3.1 Purpose

The City of Bellevue’s parks and natural areas are a reflection of the values of the community. The Parks Department strives to ensure that public landscapes remain attractive and meet the expectations of thousands of users and preserve natural ecosystems for future generations. These green open spaces offer Bellevue residents the opportunity to enjoy a natural environment within their community. Trees, shrubs, flower beds, ponds, streams and lakes make up these open spaces, and require maintenance and protection from damage by both humans as well as biological pests.

Integrated Pest Management (IPM) is a sustainable approach to managing pests by combining biological, cultural, physical and chemical methods in a way that will minimize the effects on the environment, minimize domestic and health risks, while considering budgetary restrictions. The Parks Department adopted an IPM program in 1997, which has been integrated into this manual, which outlines how both passive and active modes of maintenance are vital to the preservation of any environment. The objectives of the Parks Department’s IPM program are as follows:

- To protect the health, safety, and welfare of the community.
- To provide efficient cost-effective maintenance of the city’s park resources. This includes non-chemical controls whenever possible.

- To design new and renovate existing landscape areas that suit site conditions with sustainable maintenance practices, thus providing a comprehensive stewardship of parks and natural resources.
- To restore, create and protect environmentally valuable areas such as wetlands and riparian areas, aquatic and terrestrial wildlife habitat, forests and meadow areas.

## 3.2 Background

### **Policies and Regulations**

By legal definition, a pesticide is any substance for which a manufacturer or distributor claims pesticidal value. Today there are more than 30,000 pesticide products registered to destroy, prevent, attract or in some manner control pests.

The Insecticide Act of 1910 was the first legislative action taken in an effort to regulate the use of pesticides. Since then, there has been the Federal Insecticide, Fungicide and Rodenticide Act of 1947 (FIRFA), and more recently, the Federal Environmental Pesticide Control Act of 1972. The major provisions of this act are:

- All pesticides must be registered with the U.S. Environmental Protection Agency (EPA). Qualified states may also register pesticides under special conditions.
- All pesticides will be classified for either general or restricted use.
- Only certified applicators, or those under their supervision, may apply restricted use pesticides. States have the authority to certify applicators.
- Use of pesticide inconsistent with labeling instructions is prohibited.
- Violators may be fined or imprisoned or both.

In order to comply with this act as well as other regulations, the Parks Department ensures that all employees remain informed and receive the proper training when managing pesticides and their application.

Other important regulations pertain to working within protected areas, such as wetlands and riparian corridors, steep slopes and native growth protection areas. Certain activities are restricted in these areas and may require special permits granted by the City of Bellevue Developmental Services Department and other regulatory agencies. Further description of these areas and their restrictions will be described later in this chapter.

## Pesticide Use Decision Process

The following agencies and individuals are involved in the determination of when to use pesticides in City of Bellevue managed parks:

- The Washington State Department of Agriculture (WSDA) sets the overall policy for pesticide use in Washington State. The approved chemical list can be seen on their website at [www.agr.wa.gov](http://www.agr.wa.gov).
- The Washington Department of Ecology (DOE) requires a special permit for all aquatic herbicide applications. This permit allows herbicide control for all listed noxious weeds within an aquatic environment and monitors impact levels on non-target plants.
- The Park Resource Managers, Golf Course Superintendents, Program Supervisors, Contract Administrators and Crew Leaders are responsible for upholding and applying the Parks Department pesticide policies and procedures within their areas of control. They are also responsible for ensuring that any personal protective equipment (PPE) is available and properly fitted for use by applicable staff for any chemical application.
- The Site Managers and Crew Leaders determine the most appropriate control measure for actual landscape pest situations, including selecting the most appropriate pesticide products, if necessary. In golf maintenance, this responsibility rests with the Golf Course Superintendent or their immediate assistant. They are also responsible for the safe storage and handling of pesticides, spill responses and related training.
- The IPM Coordinator is responsible for verifying that all license holders or pesticide operators have completed their mandatory annual recertification training. This position also serves as the primary contact for providing information regarding the Parks Department IPM program to the general public and outside agencies.

## Pest Management Guidelines

The following pest management guidelines generally apply to all City of Bellevue Parks & Community Services landscapes:

- Park landscapes will be designed to minimize pest management. Where resources are available and existing design themes will not be compromised, modifying landscapes will be considered to reduce pest management.

- All reasonable, cost effective non-chemical pest control options will be considered first before resorting to the use of pesticides.
- Parks will practice IPM in all pest management situations, understanding that some situations will require the use of a pesticide product.
- Certain levels of pest problems or populations will be accepted within established thresholds. Those thresholds will vary with the pest and the landscape setting.
- Parks will not perform prophylactic or calendar-based pesticide applications.
- Only pesticides approved for that particular use will be used for the prescribed applications. When pesticides are applied, the smallest effective area will be treated and the application will be timed to minimize public contact and the effects on the environment.
- Whenever possible, pesticide applications will be carefully timed to control the pest and reduce the need for retreatment.
- In accordance with Washington State licensing guidelines, all staff and contractors who are engaged in the use, application and storage of pesticides shall have a current Washington State pesticide license. Contractors must notify appropriate Parks Department representatives prior to the application of any pesticide to a park and open space site.
- Parks Department pesticide applicators shall strictly observe all pesticide products labeled requirements. All chemicals used on parks property will have a Material Safety Data Sheet (MSDS) on file, and will be available to all staff, contractors and the public upon request.
- Pesticides shall not be used to control plants with edible fruit during the fruiting season unless the plant being controlled is not of sufficient size to produce fruit, or in a location where there is absolutely no possibility of public access. Fruiting plants such as blackberries may be first cut to the ground, allowed to re-sprout and then chemically controlled before the plant can produce fruit. Plants controlled in this manner will never be allowed to produce fruit in the future.
- All sites where pesticides have been applied shall be posted, as required by the WSDA. As required by the WSDA, all applications of pesticides will be recorded. All application records for the Parks Department will be filed in one central location at the Resource Management office and made readily available to the public upon request.

- When pesticides are used in confined environments such as greenhouses, the facility shall be clearly posted "Closed to Entry" until the re-entry time period has elapsed.
- Parks will continue its aggressive training program for all staff who apply pesticides and will continue to emphasize learning new pest control techniques as they are available.
- Parks will continue to field test alternative controls to pesticide use and will implement successful control options as budget allows.
- To promote public understanding and support of the benefits of the IPM program, educational assistance and information will be made available to the public regarding the use of pesticides.
- The city shall comply with all federal, state and local regulations pertaining to the application, handling, storage and disposal of pesticides.

## Components of an IPM Program

IPM involves a structured decision-making process that embodies the philosophy and the components of the IPM system. Through the following applications, as well as the proceeding guidelines, a well-managed IPM program can be implemented.

1. Identification of pest populations: Identify the nature, location, scale, and the intensity of the problem.
2. Determine plant injury levels: Define the tolerance levels for aesthetic and economic injuries. Prescribe the point at which actions must be taken to avoid exceeding the tolerance level.
3. Design and implement the pest management treatment: Research all possible options and design strategies. Non-target organisms must be considered at this time. Use of pesticides is limited to situations where other cultural and biological options are not likely to be successful within the context of available resources. The pesticide chosen shall be the least toxic of those available with as minimal impact possible, as defined by that chemical's use.
4. Evaluate results. Conduct follow-up inspections to support evaluation:
  - Did the pest population decline to acceptable levels?
  - Was there a negative impact on non-target organisms?
  - Do the host plants appear to be able to thrive following a successful treatment?
5. Adjust and extend program as indicated: Decide whether further treatment will be necessary, either on a temporary or permanent basis. If it will be on a permanent basis, plan potential site modifications to eradicate the problem or prevent future recurrences.

6. Create documentation of all research, monitoring and application data: A comprehensive system of forms for monitoring data and documenting treatment is a key component of a successful IPM program.
7. Share pest management information with decision-makers and maintenance staff: Professional staff must know the degree to which landscape pest management programs impact existing staff, maintenance budgets and park assets. Only through such understanding and ongoing communication can the best long-term strategies be developed for managing pest populations.

### **IPM Control Alternatives Selection Hierarchy**

The following selection rationales are used as a guide for determining whether pesticides shall be used in place of other control methods:

- Proper planning and management decisions begin the IPM process.
- Cultural methods of vegetation and pest control are preferred and will be employed first.
- If unsuccessful, mechanical means of vegetation and pest control will be employed next where practical and feasible.
- Biological means of vegetation and pest control will be employed next where they are practical and feasible.
- Pesticides will only be used when no other feasible method exists that will control the pest within the realities of the location, site conditions, budget and other relevant considerations. At the same time, it is recognized that pesticide use is a legitimate element of an IPM program.

## 3.3 Best Management Practices

### **Storage and Use Guidelines**

Every employee has a personal responsibility to themselves, other staff and the public to follow safe work practices when storing or using pesticides. The following management practices are required:

- Always read and understand the label of the chemical that you will be using.
- Store and handle all chemicals or fertilizers in a manner that minimizes worker exposure and potential for contamination of surface and ground water.

- Always have the correct MSDS on hand for all chemicals or fertilizers at your site (required by law).
- Always check the MSDS for the type of protection needed and the recommended re-entry time before the chemical is applied.
- When possible, purchase the smallest amount of any pesticide and avoid stockpiling of chemicals.
- Store fertilizer in a separate weatherproof area.
- All spray equipment shall be maintained in proper working order and stored in an OSHA approved site.
- All protective gear (masks, filters, rain gear) will be stored separately to avoid any possible contamination.
- Store and mix all chemicals in a WSDA approved storage and mixing area. Label storage area with an NFPA coded sign to protect fire department or hazmat personnel in case of emergency.
- Any pesticides in inventory that are no longer needed for use will be disposed of through hazardous materials disposal practices. The WSDA provides free disposal of unwanted pesticides at various locations throughout the calendar year.
- All chemical containers will be clearly labeled.
- A pesticide inventory will be maintained by the Resource Management Division.

### **Pesticide Application Equipment**

Pesticide application for all listed areas will be carried out by hand with directed, low-volume, single-wand sprayers, wiping, daubing and painting equipment, injection systems or drop spreaders. Typically, applications are done with backpack sprayers, but may also include sprayers with larger fill tanks providing the same kind of hand application method is used. These methods of delivery result in low volume applications at low nozzle pressures. This practice minimizes the formation of fine mists that can result in pesticide drift. These practices also help ensure that the pesticide applied will reach only its intended target. In large open turf areas, boom type sprayers may also be employed. Boom sprayers are efficient and expedient tools used to destroy weed species after they have exceeded the acceptable threshold level. Broadcast applications shall be avoided unless absolutely necessary.

### **Personal Protective Equipment (PPE)**

Table 3.1 shows the personal protective equipment required by city, state, and federal regulations for pesticide use.



### **Chemical Application near Watercourses & Aquatic Habitats**

Generally, the use of chemical products within 50 feet of a watercourse shall be prohibited in favor of an alternative control method. If a pesticide must be applied within the 50-foot buffer, only products registered for use near water bodies shall be used, and great care will be taken to ensure that the product does not migrate into the watercourse either through drift or by overland flow. All applications will be made under the guidelines of the NPDES Aquatic Noxious Weed Management General Permit as issued by the Washington State DOE. Weather conditions must be monitored carefully to avoid applying a chemical near a watercourse immediately before heavy rains. Soil conditions and site topography must also be carefully studied to determine the appropriate timing of a chemical application and/or whether a chemical should even be applied at the site.

### **Chemical Application in Watercourses**

Generally, the use of chemical products within aquatic environments shall be prohibited in favor of alternative control methods. In limited situations, the city may apply herbicides directly to watercourses to control wide spread noxious aquatic vegetation, such as Eurasian Water Milfoil, within public marinas, boat launches and swimming beaches. In such applications, only products registered for use in aquatic environments and approved by the DOE will be used. Chemical applications will be contained to the area of infestation and applied under requirements established through the NPDES Aquatic Plant & Algae Management General Permit issued by the Washington State DOE. Aquatic pesticide applications will generally be contracted out to specialized aquatic weed management agencies and supervised by city staff.

**Table 3.1** Personal Protective Equipment (PPE) Guide for Using Pesticides

Form of Pesticide	LABEL SIGNAL WORD		
	CAUTION	WARNING	DANGER
<b>Dry</b>	<ul style="list-style-type: none"> <li>• long-legged pants</li> <li>• long-sleeved shirt</li> <li>• shoes &amp; socks</li> </ul>	<ul style="list-style-type: none"> <li>• long-legged pants</li> <li>• long-sleeved shirt</li> <li>• shoes &amp; socks</li> <li>• wide-brimmed hat</li> <li>• gloves</li> </ul>	<ul style="list-style-type: none"> <li>• long-legged pants</li> <li>• long-sleeved shirt</li> <li>• shoes &amp; socks</li> <li>• hat</li> <li>• gloves</li> <li>• cartridge or canister respirator if dusts in air or if label precautionary statement says "Poisonous or fatal if inhaled"</li> </ul>
<b>Liquid</b>	<ul style="list-style-type: none"> <li>• long-legged pants</li> <li>• long-sleeved shirt</li> <li>• shoes &amp; socks</li> <li>• wide-brimmed hat</li> <li>• gloves</li> </ul>	<ul style="list-style-type: none"> <li>• long-legged pants</li> <li>• long-sleeved shirt</li> <li>• shoes &amp; socks</li> <li>• wide-brimmed hat</li> <li>• rubber gloves</li> <li>• goggles if required by label precautionary statement</li> <li>• cartridge or canister respirator if label precautionary statement says "Do not breathe vapors or spray mist" or "Poisonous if inhaled"</li> </ul>	<ul style="list-style-type: none"> <li>• long-legged pants</li> <li>• long-sleeved shirt</li> <li>• rubber boots</li> <li>• wide-brimmed hat</li> <li>• rubber gloves or face shield</li> <li>• cartridge or canister respirator if dusts in air or if label precautionary statement says "Poisonous or fatal if inhaled"</li> </ul>
<b>Liquid when mixing</b>	<ul style="list-style-type: none"> <li>• long-legged pants</li> <li>• long-sleeved shirt</li> <li>• shoes &amp; socks</li> <li>• wide-brimmed hat</li> <li>• gloves</li> <li>• rubber apron</li> </ul>	<ul style="list-style-type: none"> <li>• long-legged pants</li> <li>• long-sleeved shirt</li> <li>• shoes &amp; socks</li> <li>• wide-brimmed hat</li> <li>• rubber gloves</li> <li>• goggles or face shield</li> <li>• rubber apron</li> <li>• cartridge or canister respirator if label precautionary statement says "Do not breathe vapors or spray mist" or "Poisonous if inhaled"</li> </ul>	<ul style="list-style-type: none"> <li>• long-legged pants</li> <li>• long-sleeved shirt</li> <li>• rubber boots</li> <li>• wide-brimmed hat</li> <li>• rubber gloves</li> <li>• goggles</li> <li>• rubber apron</li> <li>• cartridge or canister respirator if label precautionary statement says "Do not breathe vapors or spray mist" or "Poisonous if inhaled"</li> </ul>
<b>Liquid (prolonged exposure to spray, or application in enclosed area)</b>	<ul style="list-style-type: none"> <li>• long-legged pants</li> <li>• long-sleeved shirt</li> <li>• boots</li> <li>• rubber gloves</li> <li>• waterproof wide-brimmed hat</li> </ul>	<ul style="list-style-type: none"> <li>• water-repellent long-legged pants &amp; long-sleeved shirt</li> <li>• rubber boots</li> <li>• rubber gloves</li> <li>• rubber apron</li> <li>• waterproof wide-brimmed hat</li> <li>• face shield</li> <li>• cartridge or canister respirator if label precautionary statement says "Do not breathe vapors or spray mist" or "Poisonous if inhaled"</li> </ul>	<ul style="list-style-type: none"> <li>• waterproof suit</li> <li>• rubber boots</li> <li>• rubber gloves</li> <li>• waterproof hood or wide brimmed hat</li> <li>• face shield</li> <li>• cartridge or canister respirator if label precautionary statement says "Do not breathe vapors or spray mist" or "Poisonous if inhaled"</li> </ul>

## **IPM Best Management Practices**

Bellevue Parks maintains a wide variety of landscape types, each with unique pest control issues and control measures. For these reasons, the pest control measures specific to each landscape are dealt with separately in this section. If chemical applications are required, only chemicals approved for a specific location will be used in that location. Parks staff only use city approved chemicals on park properties.

### **Control of Special Pests**

#### **Blackberries**

An aggressive, invasive plant, Himalayan blackberry will overtake a disturbed site at an alarming rate. Mechanical control is not very effective by itself, but combined with chemical control measures and replanting of the site, effective control can be maintained. Chemical applications shall be kept to the area of infestation. Treatment efforts should include re-vegetating the site with desirable plant species.

#### **Scotch Broom**

An unruly plant, it thrives on disturbed sites. It is difficult to control and spreads rapidly. This plant can be toxic to humans, making it a high priority for eradication. Manual control can have some effect, but it must be done at the proper time of year. Chemical control can also be effective, but requires follow up management techniques until full eradication occurs. Chemical applications shall be kept to the area of infestation.

#### **English Ivy**

A very aggressive, invasive, introduced plant, Ivy is difficult to control or eradicate. Manual or mechanical control is somewhat effective, but highly time consuming. A combination of mechanical and chemical control is more effective and spread can be kept to a minimum with continuous control measures. Chemical applications shall be kept to the area of infestation.

#### **Horsetail**

Although native to the Pacific Northwest region, horsetail is considered by many to be a nuisance and is often controlled like a noxious weed. It is almost impossible to control manually or mechanically. Horsetail can be controlled with herbicides. As with other chemical controls, chemical application shall be contained to the area of infestation. Horsetail is an indication of high-water content in soil, so any use of herbicides should be well thought out and carefully timed.

**Eurasian Water Milfoil**

Because it is widely distributed and difficult to control, milfoil is considered to be one of the most problematic invasive aquatic plants in Washington State. Milfoil can drastically alter a water body's ecology and significantly interfere with recreational activities such as swimming and boating. Because of its wide distribution, eradication is not practical. Therefore, a "management" approach has been adopted to control the spread of milfoil within public marinas, boat launches and swimming beaches. A combination of manual and chemical control shall be used to achieve the most effective results.

**Garlic Mustard**

Garlic mustard is an invasive non-native biennial herb that spreads by seed. It is difficult to control once it has established at a site. It out competes native vegetation and it can establish in a relatively stable forest understory. Plant stands can produce more than 62,000 seeds per square meter which can quickly out compete local flora, changing the structure of plant communities on the forest floor. This noxious weed has been discovered within the Coal Creek Natural Area, Eastgate Park and Forest Park Open Space, and is aggressively managed by Bellevue Parks staff in cooperation with King County primarily with herbicide applications.

**Pennywort**

Although native to the Pacific Northwest region, pennywort has become widespread and problematic at the Mercer Slough Nature Park. Pennywort forms a dense mat of leaves at the water surface which can impede recreational boating. A combination of mechanical and chemical control is the best method for controlling pennywort. The primary focus in controlling pennywort at the Mercer Slough is to maintain access for recreational boaters.

**Poison Hemlock**

This noxious weed is acutely toxic to people and animals. It is most commonly found along roadsides, in open fields and in natural areas. Unrelated to the native evergreen hemlock tree, poison-hemlock can be deadly. As such, this weed is aggressively managed, typically with use of herbicides, when discovered in Bellevue managed parks.

**Tansy Ragwort**

This invasive, toxic biennial is most often found in pastures and along roads and trails. Although animals tend to avoid it, they may eat enough of it to cause health problems. Despite efforts to control it, tansy ragwort is widespread in the Pacific Northwest and can be found within some Bellevue

parks. This weed is best controlled by using a combination of manual control and herbicide application.

#### **New Zealand Mud Snails**

This invasive species has been discovered in Kelsey Creek (Kelsey Creek Park), Valley Creek (Highland Park), upper Vasa Creek (Horizon Heights Open Space & Whispering Heights Open Space), Sunset Creek (Eastgate Park) and Coal Creek (Coal Creek Natural Area). The city has developed protocol to prevent the further spread of this invasive species. Decontamination of equipment, personal gear and increasing public awareness is the most effective method of controlling the spread of the New Zealand mud snail.

#### **Rats**

Rats are only somewhat problematic in Bellevue parks. Bellevue does have some natural predators of rats which help alleviate many of the problems that could occur. They do pose a human health risk and will be controlled in given situations. The common method of control is baiting with an approved rat bait/trap. Extreme caution must be taken to place rat bait in locations where people or domestic animals cannot access it.

#### **Mice**

Mice are becoming an increasing human health problem from Hanta virus. Mice control is not currently a major pest control issue in park facilities, but increased control measures may be required in the future based on the history of the virus.

#### **Moles**

Moles can cause significant damage and disfigurement to turf areas in developed parks, athletic fields and golf courses. Moles can also destroy flower beds and damage underground utilities. Since mole trapping is outlawed in Washington State, approved mole baits have become the most common control method utilized by the Parks Department. Extreme caution must be taken to place mole baits in locations where people or domestic animals cannot access them.

#### **Yellow Jackets, Hornets and Wasps**

These insects often require control in parks. Control is typically through use of an approved insecticide. Only individual nests are treated and only if the nest poses an imminent risk to humans using park facilities.

#### **Vector-borne Disease**

Here in the Pacific Northwest, vector-borne diseases have increasingly become an issue. The most significant is mosquito-borne diseases, such as the West Nile Virus (WNV). Complete control of mosquito infestations is nearly

impossible, but cultural control can have some effect, such as removing any standing-stagnant water from any sites. Larvicides may also be used to control mosquito infestations if it's determined that public health concerns warrant their use. As part of the city-wide WNV response plan, surveillance (dipping) for pond facilities will be included during the mosquito season when human cases are reported in the Puget Sound region.

## **IPM for Greenhouse Operations**

Greenhouses are a production operation dealing with large numbers of plants, of similar species, in a closed, non-public environment. Because of these factors, the tolerance threshold for many pest problems is much less in the greenhouse environment than it is in general park landscapes, requiring the use of a broader palette of pesticide products.

### **Pest Tolerance Thresholds**

Weeds are not tolerated in the city greenhouse.

- Insects or disease pests that threaten the health of plant collections or production crops are not tolerated in the greenhouse.
- Display spaces shall be kept free of weeds.

### **Pest Management Strategies**

#### **Weed Control**

- Greenhouse operating areas, containers and conservatory shall be maintained through hand/manual weeding.
- Weeds shall be controlled in exterior spaces, building perimeters, shade houses, cold frames and related areas either by hand or mechanically with push type mowers and string trimmers or suppressed with landscape fabrics.
- Exterior areas shall receive pesticide treatments for weed control if they impact interior production.

#### **Insect Control**

- Insect pests shall be routinely monitored by visual inspection or the use of "sticky traps."
- Cultural practices including regular irrigating and fertilizing shall be used.
- Insects should be removed by hand or washed off the affected parts of the plants.
- Biological controls, such as beneficial insects and other organisms that attack pest insects, should be used to keep pest populations under

control. Periodic release of beneficial insects helps to suppress and reduce the need for chemical control.

- Spot treatments of the least toxic, yet effective, insecticide shall be directed at specific plant parts for specific pest control.

#### **Disease Control**

- Good sanitation techniques shall be provided, including regular removal of plant debris, and keeping tools and work areas clean.
- Plants shall be properly spaced to provide good air circulation.
- Disease resistant plants shall be selected.
- Diseased plants shall be kept away from healthy crops.
- The least toxic, but effective, pesticide product shall be applied to control specific disease pathogens on specific plants or crops.

### **IPM for Nursery Operations**

The Bellevue Nursery, located on SE 16th Street, is a facility for the growing of plants for use on developed and undeveloped park property. It occupies roughly five acres of property and has been in continuous operation for more than 40 years. The plants provided by the nursery operation include natives as well as ornamentals, groundcovers, vines, perennials, shrubs and trees. The plants are grown to support various needs throughout the park system ranging from small in-house planting projects to large capital Improvement projects. Control of pests in the nursery environment is significant since many plants may be affected at one time.

#### **Pest Tolerance Thresholds**

Pests that threaten the health of the nursery crops will not be tolerated and will be controlled.

#### **Pest Management Strategies**

##### **Surface and Groundwater Protection**

- General site runoff is controlled through biofiltration.
- Select the least toxic and most non-leaching chemical products only when necessary.
- Precisely follow all label instructions.

##### **Weed Control**

- Most weed control at the nursery is accomplished through hand weeding, mulching, and use of landscape fabrics.
- When other controls have failed, herbicide is used for spot control of weeds.

**Insect Control**

- Habitat for natural insect pest predators will be encouraged as an environmentally sound means to reduce populations of insect pests.

**Disease Control**

- Select disease-resistant plant varieties.
- Monitor plant crops for disease outbreaks.
- Practice good cultural practices including watering, fertilizing, pruning and maintaining good air circulation.
- Reduce the potential for transfer of disease through good sanitation techniques. These practices include keeping growing areas, tools and containers clean and removing plant litter and debris in a timely manner.

**IPM for Planting Beds**

Planting beds are defined as non-turf planted areas that include woody plant material such as shrubs, trees and ground covers. This category also includes floral color displays containing herbaceous plants such as perennials, annuals and bulbs. The most serious pest management issue in planting beds is weed control. If not controlled, weeds not only make a planting bed appear unkept, but more importantly, they can outcompete desirable landscape plants resulting in a loss of assets. The table on the following page shows pest tolerance thresholds and IPM principles that shall be employed in selecting maintenance methods for planting beds.



**TABLE 3.2** Pest Tolerance Thresholds for Planting Beds

Area	Weeds	Insects	Disease
General Landscape Beds	<ul style="list-style-type: none"> <li>• Some weeds acceptable</li> <li>• Goal is for bed areas to be free of weeds for both asset protection and appearance</li> <li>• Weeds will not be allowed to outcompete desirable landscape plants</li> </ul>	<ul style="list-style-type: none"> <li>• Generally tolerated unless particularly valuable plants are threatened</li> </ul>	<ul style="list-style-type: none"> <li>• Occasionally tolerated</li> <li>• Manual and cultural controls preferred</li> <li>• Chemical controls used to save specimens</li> </ul>
Highly-visible/ Public facility landscapes/ Bellevue Botanical Gardens	<ul style="list-style-type: none"> <li>• Generally not acceptable</li> </ul>	<ul style="list-style-type: none"> <li>• Generally tolerated unless they threaten particularly valuable plants</li> <li>• Manual removal of pests is encouraged</li> </ul>	<ul style="list-style-type: none"> <li>• Occasionally tolerated</li> <li>• Manual and cultural controls preferred</li> <li>• Chemical controls used when other means fail</li> </ul>
Floral beds	<ul style="list-style-type: none"> <li>• Generally not acceptable</li> </ul>	<ul style="list-style-type: none"> <li>• Generally tolerated</li> </ul>	<ul style="list-style-type: none"> <li>• Disease problems tolerated</li> <li>• Plants may be replaced when appearance is impacted</li> </ul>
Newly-established landscapes	<ul style="list-style-type: none"> <li>• Weed control is very important to ensure complete establishment of desired plants</li> </ul>	<ul style="list-style-type: none"> <li>• Generally tolerated</li> <li>• Presence of pests may result in host plant being removed and replaced</li> </ul>	<ul style="list-style-type: none"> <li>• Minor disease problems may be tolerated</li> <li>• Presence of disease problems may result in host plant removal and replacement</li> </ul>

**Pest Management Strategies**

**Weed Control**

- Weeds are controlled by hand pulling, or by mechanical methods in larger planting beds.
- Whenever feasible, planting beds will be mulched after planting to suppress new weed growth.
- Spot treatment with herbicides shall be used as necessary.

**Disease Control**

- Diseased plants shall be hand pulled from planting beds and discarded appropriately.
- Disease resistant plants shall be planted in all planting beds, whenever possible.

## IPM for Trees

Trees are an integral part of most landscapes, whether formal or natural, and are considered an asset. They provide shade, clean the air of pollutants, modify both micro and macro climates and provide visual relief to the urban environment. Because trees are often very large and tall, accessing and managing insects and disease can be quite difficult and costly.

### Pest Tolerance Thresholds

In general, insect and disease pests in trees, including trees located in streetscapes, are tolerated.

- Insect or disease pests in selected, high-value specimen trees may be subject to control measures.

### Pest Management Strategies

#### Physical Damage to Trees

- Physical damage to trees can be a major factor in overall loss of trees. This damage most often occurs in one of two ways. One is when trees are repeatedly struck by mowing equipment. A second form of injury is by string trimmers, which can damage bark leading to the intrusion of pathogens and ultimately to tree loss. Many trees are also lost to lack of appropriate care during construction projects within existing parks.
- Removing turf from around the tree base to create tree mulch rings 3 to 4 feet in diameter can substantially reduce damage caused by mowers and trimmers. With tree mulching, a mower or trimmer never has to come close enough to the tree to cause damage. The tree mulch ring will need to be kept free of grass and weeds.
- Following the BMPs in Chapter 1 - Construction Site Management, substantially reduces or eliminates damage from construction activities.
- All pruning for tree health reasons and for hazard reduction will be done in conformance with the International Society of Arboriculture standards.

#### Insect Control

Parks does not actively control insect pests in trees. This is particularly true of large trees where the control of the pest might require the use of large aerial spray equipment, which carries with it a high probability of the insecticide applied leaving the area due to wind drift. For example, Parks does not spray aphids despite the "honeydew" problem associated with them. When insect pests are controlled in trees, the following measures are used:

- Trees that are highly susceptible to specific insect pests (such as blue spruce and spruce aphids) may be removed from the landscape and replaced with resistant species.
- When possible, the portion of the tree affected by the insect (such as tent caterpillars) can be physically removed, eliminating the pest.
- An insecticide may be applied to control a specific insect pest in very select situations. These situations include pests on specimen quality trees at special gardens or in high visibility locations where the presence of the pest threatens the life of the tree. In these situations, general foliar applications will not be made unless the potential for product drift can be controlled.
- Injection technology when practical may allow for systemic control of certain insect pests with minimal or no impact to human or environmental health.

#### **Disease Control**

Dutch Elm Disease and *Anthracnose* on London plane trees are the only tree diseases the Parks Department actively controls with pesticides. Most other diseases are tolerated in trees, unless they lead to a tree becoming a hazard to the surrounding environment. As with insecticides, it is unlikely that parks staff will subscribe to general foliar applications of fungicides or similar pesticide products to control disease pests in trees. The following are control measures that can be performed:

- Trees that are susceptible to particular disease pathogens may be removed from the landscape and replaced with resistant varieties.
- When possible, parts of trees affected by disease should be pruned out and properly disposed to stop the spread of disease within the tree and to adjacent trees.
- An appropriate fungicide may be applied to control a specific disease pathogen in very selected situations. These cases include specimen quality trees in special gardens or in high-visibility park locations where the presence of the disease threatens the life of the tree. In these situations, general foliar applications will not be made unless the potential for product drift can be controlled.
- Injection technology, when practical, may allow for systemic control of certain disease pests with minimal or no impact to human or environmental health.

## IPM for Turf

The Parks Department maintains a wide variety of turf types. These include park lawn areas (both formal and informal), athletic fields, golf courses and meadow areas. Each of these turf types has different pest management challenges, and practices may vary accordingly.

### Pest Tolerance Thresholds

Some level of weed, insect and disease pests are tolerated in general park lawn areas.

- Weed, insect and disease pests are typically tolerated in general park lawn areas.
- Turf pests in highly maintained areas such as athletic fields, beach parks and other high-visibility/high-use areas are generally controlled through good turf cultural practices.
- Pesticides can be applied to park turf areas only when thresholds for weeds, especially in high profile areas, become unacceptable.
- Because of the unique conditions present on golf courses, a variety of pest control measures are used, including mechanical, cultural and chemical.

### Pest Management Strategies

#### Weed Control

Weeds in turf are tolerated, to some level, with the exception of golf course turf and a few high-visibility park turf areas. When control is necessary, the primary method is through the following cultural practices:

- Careful monitoring of watering practices
- Fertilization
- Aeration
- Top-dressing
- Over-seeding

By performing this preventive maintenance, park turf is healthier and better able to compete with various broadleaf weeds. Chemical weed control may be used for controlling particularly difficult weeds in high-visibility turf areas.

- In these rare situations, the least toxic, least residual pesticide will be used.
- Pesticide use should be avoided near waterways.
- In general, broadcast applications will be avoided.

- The timing of such applications will be made to avoid contact with the public to the greatest extent possible.
- Posting of the site that has been treated will be done as legally required to meet or exceed legal requirements.
- Maintenance of municipal golf courses include treatment of broadleaf weeds through cultural practices and spot application of carefully selected herbicides.

#### **Insect Control**

The only insect pest of significance for turf in the Bellevue area is the European Crane Fly. While it can be quite damaging to turf areas, the crane fly is not controlled by prophylactic means in Bellevue managed parks.

- Chemical control is used in limited circumstances for highly visible and valuable turf areas such as golf courses, athletic fields and formal park areas.
- Chemical applications will consist of spot treatments directed specifically at the turf areas containing the pest.
- The preferred initial choice for application in high-use areas will be the least toxic product available.

#### **Wood Brush Control**

Woody brush control in meadows may require the use of chemical controls if mechanical control measures are not adequate. Cultural practices, such as frequent mowing, are the preferred methods of control.

#### **Disease Control for General Park Turf**

Disease in general park turf is typically tolerated and not actively controlled.

- In high-use/high-visibility park turf areas, disease will be controlled to a considerable degree by performing sound cultural practices.
- Pesticides may be used as a last resort to control disease in park turf areas.

#### **Disease Control for Golf Course Turf**

Because turf disease can be a significant problem on golf courses, it must be controlled to preserve the function of this asset. Golf course turf, particularly greens and tees, must perform under extreme conditions of maintenance and use. These conditions make golf course turf more susceptible to disease than general park turf.

- Golf turf disease is controlled through cultural practices to the greatest extent possible.

- Certain diseases are controlled through the application of an appropriate fungicide.
- When used, fungicides are applied to the diseased turf only, such as a green.
- The least toxic and still effective products are used.
- The fungicide used will be rotated annually to reduce the chance of the turf disease developing a resistance to the chemical control.

### **Grass Trimming Abatement**

The control of grass growing along fence lines and around trees, bollards, posts and other landscape features is a regular maintenance activity that helps preserve the asset by allowing large riding lawn mowers to steer clear of objects. This is especially important around trees where impact from mower damage can easily lead to tree loss. At the same time, keeping this grass controlled allows for parks to appear clean and well kept. This grooming affects how the public uses park facilities. Well-maintained parks are subject to less vandalism and related misuse. The following are BMPs for grass trimming abatement:

- Line trimmers or push mowers: The grass is trimmed using gas-powered line trimmers or push-type lawn mowers. This labor-intensive practice is costly and produces noise and air pollution.
- Herbicide: Post-emergent applications may be performed as needed to keep tree rings, planting beds and similar areas weed free. In general, the use of pre-emergent herbicides shall not be used unless absolutely necessary.
- Concrete mow strips: As resources are available, it is sometimes possible to provide a “mow strip” of concrete or a similar low maintenance product around some landscape features to eliminate the need for grass trimming. This control option can be costly and doesn’t work in all situations.

### **IPM for Natural and Sensitive Areas**

Natural areas are undeveloped open space properties that are owned and managed by the Parks Department. These properties typically contain sensitive areas such as steep slopes, wetlands and riparian corridors. These sensitive habitats shelter native ecosystems and wildlife habitat and include nearly all classifications in the city’s *Sensitive Areas Manual*, including steep slopes and slide prone areas. For the purposes of this BMP manual, these resource assets are divided into three major groups:

- Wetlands, riparian corridors, shorelines and aquatic habitats

- Forests
- Meadows

### **Pest Tolerance Thresholds**

- Invasive plants are generally not tolerated. Invasive plants will be controlled in conjunction with natural resource enhancement efforts in these environments as resources permit and where control can be practically achieved.
- Noxious weeds will not be tolerated and will be controlled when found in conformance with State of Washington and/or King County mandates.
- Only insect pests that pose a risk to the public (such as hornets) or to the resource (such as gypsy moth) will be controlled.
- Plant diseases will generally be tolerated unless: a specific control can be employed that will be effective in ensuring the health of particularly valuable assets; or if they pose a threat to other plant populations outside of the natural area; or if they pose an unacceptable risk to the public.
- Herbicide Use: The use of herbicides in any natural environment must be carefully considered. Herbicides will be used for weed control in natural areas only when other control measures have been tried and failed, and only if control can be achieved through the use of an herbicide, and is imperative to the health of the site. For wetland or aquatic environments, only herbicides approved for aquatic use will be used. When needed, herbicide use practices are as follows:
  - Cut and stem treatment (daubing or painting) is the preferred choice for natural area management.
  - Certain invasive plants are difficult to treat and control in their mature form. If possible, remove existing growth manually or mechanically. Wait for new growth to become established, then treat with the appropriate and approved herbicide.

### **Pest Management Strategies**

#### **Weed Control**

An overriding principle of IPM is the maintenance of healthy plant communities. That means weed control of the following types:

- Timed mowing: Carefully timed mowing before seed set can effectively reduce weed seed sources. Frequent mowing can eliminate blackberry and other woody species.

- **Mulching:** Mulching around the base of plantings is widely accepted as a horticultural practice for soil fertility and weed control. In most instances, composted wood chips or onsite recycled leaf litter are adequate materials. Avoid using wood chips from diseased trees. Mulch should be between 2 to 3 inches deep for the best results.
- **Weed monitoring during mulching:** Care must be given to not incorporate new weed problems when importing mulch materials.

**Woody Brush Control:**

The control of woody brush, like blackberry, is very important in certain park locations. Often these plants are found in transition areas between developed park areas and natural areas. If not controlled, woody brush can easily overtake forest-edge environments, eliminating vital habitat opportunities. Control measures for woody brush include the following:

- Manual or mechanical removal using hand tools or gas-powered equipment. Special tools are now available for removing woody brush. In many areas, this can provide effective control.
- Chemical control can be employed when other measures are not mechanically or economically feasible. Spot applications are preferred, whenever possible, over large area applications.

**Insect Control:**

Insects like the European and Asian Gypsy moth and the Asian Long Horned Beetle can potentially devastate Bellevue's urban forest. Parks will cooperate with state and federal agencies in their monitoring and control programs to prevent the introduction of these pests.

**Disease Control – Root Rots:**

Even native forests can have serious disease problems. Root rots are the most serious problem, leading often to the death of significant trees. Several strategies help control root rot in forests:

- Inoculate with mycorrhizae
- Remove infected wood
- Plant resistant varieties
- Do not change site conditions on mature trees

**Stump Re-Sprouting Control:**

Often there is a need to remove small trees and prevent re-sprouting of a stump. Methods for controlling the re-sprouting of stumps include the following:



- If the location of the stump allows access by equipment, then they can be mechanically removed providing the location is not within an environmentally critical area.
- Small stumps may be removed manually providing they are not on steep slopes or in other environmentally critical areas.
- The re-sprouting of stumps can also be controlled by painting newly cut stump surfaces with an herbicide. Care will be taken to limit the application of the selected herbicide to the stump surface only.
- The preferred and most commonly used chemical method for controlling stump re-sprouts is injection with a Lance EZ-Ject tool.

#### **Invasive Plant Control:**

Invasive plants have taken over many of the city's forested areas and have radically and negatively impacted natural ecosystems. Attaining long-term control of invasive plants is essential to the recovery and preservation of Bellevue's natural ecosystems. Invasive plant control shall follow the guidelines established by the *King County Noxious Weed Board*. Except in the case of Class A weeds, the goal is suppression of weed populations to below threshold (damage causing) levels. Eradication of certain ecological weeds (blackberry or ivy) in all of the city's natural areas is neither feasible nor cost-effective. However, controlling the spread of the problem and eradicating it in certain priority locations is the goal. Control methods include:

- Use *extent of removal* and *type of habitat* to determine the pest control method.
- Large areas that are totally infested can be mowed. Areas that are interspersed with invasive pests require more selective procedures such as manual removal.
- Heavy equipment or manual removal can be used on firm soils. On either steep or saturated soil, use techniques that will minimize site or slope disturbance.
- Where mechanical or manual removal is neither possible nor practical, but control is essential, careful and selective use of an approved herbicide is permitted.
- Re-establishing a new native planting regime as quickly as possible following the removal of invasive plants is critical to successful forest restoration. These new plantings generally require 3-5 years of watering and maintenance to insure successful establishment.
- Preserve established native plants when possible rather than re-establishing new plants after the clearing of invasives.

- Public education and outreach concerning plant identification and management techniques will also aid the Parks Department in controlling noxious weeds.

**Nuisance Wildlife Control:**

Mountain beavers, moles, coyotes, beavers, opossums, raccoons, waterfowl and other species can be destructive to natural areas when their activities are excessive. Overall, the Parks Department does not encourage the interference with wildlife and prefers to leave them to their natural behaviors. If control of wildlife is deemed necessary, the Parks Department will work with the most appropriate county (Animal Control) or state (Department of Wildlife) agency to formulate a control solution.

**IPM for Trails****Pest Tolerance Thresholds**

Invasive plants that invade the trail area are generally not tolerated. Invasive plants will be controlled in conjunction with ecosystem restoration efforts on any park trail as resources permit.

- Noxious weeds will not be tolerated and will be controlled when found in conformance with State of Washington and/or King County mandates.
- Weeds are generally found on trails and many will be tolerated. Weeds that begin to form a hindrance of trail function will be eradicated.
- Only insect pests that pose a risk to the public (e.g. hornets) will be controlled.

**Pest Management Strategies****Weed Control:**

Weeds on trails are generally tolerated, until they begin to interfere with trail function and safety. When control is necessary, the primary method is increasing mulch on, or re-surfacing, the trail surface. Chemical weed control is often not necessary on trail surfaces but will be used only as a last resort for controlling particularly difficult weeds.

- In these rare situations, the least toxic, least residual herbicide will be used for spot treatments.
- General broadcast treatments will be avoided.
- Timing of such applications will be made to avoid contact with the public to the extent possible.

- Posting of the site that has been treated will be done as legally required.

### **Insect Control:**

Overall, insects on trails are tolerated. Only insects that can cause a health risk are controlled. Wasps and hornets are some of the few insects that will be eradicated immediately when encountered. When this is necessary, chemical control with an approved insecticide is the preferred method, and only individual nests will be treated.

## **IPM within Agricultural Areas**

### **Pest Tolerance Thresholds**

Invasive plants that invade agricultural areas are generally not tolerated. Invasive plants will be controlled as resources allow.

- Noxious weeds will not be tolerated and will be controlled when found in conformance with State of Washington and/or King County mandates.
- Weeds are generally found in agricultural areas and many will be tolerated. Weeds that begin to interfere with crop production will be eradicated.
- Only insect pests that pose a risk to the public (e.g. hornets) will be controlled.

### **Pest Management Strategies**

#### **Weed Control**

Generally, weeds are tolerated in agricultural areas. When control is necessary, mechanical practices are the primary methods.

- Mowing
- Hand pulling
- Herbicides are used only in extreme cases

#### **Insect Control**

Insects are not a high concern on agricultural farms. In the past, there has been little need to utilize insecticides, except in the case of hornet nests. The selective use of surfactants has proven to be effective for controlling minor insect breakouts.

#### **Disease Control**

Most agricultural areas managed by the Parks Department are within wetlands. Disease issues related to that kind of environment make control

more difficult. At the present time, only fungicides approved for a wetland environment have been used to control diseases such as “mummy berry”, which is a serious disease on blueberry farms. The following control measures may be performed to prevent spread of diseases:

- Drainage of crop rows to reduce root rot.
- Spot application of an approved fungicide. In these situations, general foliar application will not be made unless the potential for product drift can be controlled.
- Clean cultivation or tilling of the soil around crop plants to bury mummified berries to 1 inch will help prevent the disease from spreading in the following year.

#### **Fertilizer Use**

The Parks Department does not use fertilizers on any agricultural lands.

#### **Nuisance Wildlife**

There is some need for the control of nuisance wildlife on managed agricultural lands. Most of the farms grow fruits, which are highly appealing to many wildlife populations. Most grazing by wildlife is tolerated, with the exception of Starlings. They pose a major detriment to the farm as they can consume large amounts of foods and are very abundant. The Starling population has risen to such a level that extreme measures of control have been considered. Presently, the Parks Department uses bird calling machines placed throughout the farm areas as a deterrent to Starlings and other birds.

## 3.4 Training

Because IPM is an ecologically sophisticated process that requires professional expertise in vegetation and pest management, it demands trained field personnel that are knowledgeable about:

1. Ecological interactions and relationships among vegetation and pests;
2. Potential tools and materials that can be used to effectively manage vegetation and pests by manipulating environmental conditions; and
3. Correct timing for implementing specific management practices relative to vegetation and pest biology.

Educational and career opportunities in IPM will enhance crew professionalism, their knowledge of current vegetation and pest management practices, and their stewardship of managed landscapes. Each landscape type will have an individualized training program developed and accessible to all applicable staff.

(This page intentionally left blank)

## CHAPTER 4 –

# Irrigation and Water Management



## 4.1 Purpose

Water resources are an important part of the Parks & Community Services Department's landscape assets. Turf, shrubs and trees all require water to live, but not all require the same amounts. Wise water use must consider both the preservation of landscape assets and the impact on the broader watershed. An efficient irrigation program makes the best use of the resource by not wasting water vital to other natural resources, such as fish, while at the same time preserving landscape assets.

The design and programming of irrigation systems is complex. It requires understanding the principles of hydro-zoning and knowledge of basic hydraulics, site conditions such as soils, slopes and plants, and knowledge of the irrigation system tools themselves. As competition for available water becomes more acute, the department will continue to be equally dedicated to carefully managing this resource.

## 4.2 Background

Best management practices for irrigation system operations combine activities for maximizing a range of technologies for water control and common field practices.

### **Irrigated Park Areas**

Because the Parks Department's mission is to preserve all landscape assets, most developed landscape areas are irrigated, including the following:

- Athletic fields
- Community and neighborhood parks
- Golf greens, tees and fairways
- Most turf areas
- Most shrub and annual plant beds
- Newly installed landscapes
- Most areas in high-use or high-visibility parks
- Specialty gardens
- City building facilities
- Natural areas under active restoration

### **Non-Irrigated Park Areas**

The following City assets are not irrigated:

- Meadow areas
- Natural areas
- Low visibility and low use turf areas

### **Design**

Irrigation design is the foundation of sound water management. The design process involves determining which sites to irrigate, what portions of each site should be irrigated, and choosing the appropriate automated system. (Note: all new irrigation systems are designed and installed in compliance with City of Bellevue's water budget requirements.)

### **Choosing an Automatic Irrigation Control Option**

The City of Bellevue utilizes a variety of controllers for timing the application of irrigation water. These automatic controllers serve three primary purposes:

1. Operate remotely rather than manually, saving labor hours and water.
2. Accurately time irrigation to specific needs of soils, slopes and plants.

3. Reduce impacts to park use and water loss from evaporation by operating at night.

## **Types of Irrigation Controllers used in Bellevue Parks**

Four types of irrigation controllers are used in Bellevue managed parks and streetscapes:

### **Electric Controllers**

These controllers use electrical circuitry. Advantages of these controllers include relatively low cost, significant programming flexibility and ease of repair. The only disadvantage of these controllers is that they operate as stand-alone units, thereby lacking the savings potential of central computer control. Electric is the preferred controller for parks that will not be connected to central control.

### **Battery-Operated Controllers**

Battery-operated controllers are either mechanical or solid-state controllers that operate from a DC power source. They are typically used at locations where automatic irrigation is desirable but access to electric power is not feasible. The city uses very few of these devices currently as constant monitoring is required to make the systems reliable. Batteries are subject to failure and moisture problems, requiring regular replacement.

### **Solar Powered Controllers**

Solar powered controllers utilize solar energy to provide power for the controller. This technology requires the use of on-site solar panels which are susceptible to vandalism and misuse. The Parks Department has yet to find reliable solar powered equipment, however, will continue to experiment with this technology as newer and improved equipment is made available.

### **Computer ET Based (Maxicom and IQ)**

Maxicom and IQ are the brand name for the centralized computer-controlled ET based irrigation system that the Parks Department uses at those park and streetscape sites where communication linkages are possible. The use of a centralized ET based computer system provides the following advantages as it pertains to irrigation water management:

- Allows our irrigation systems to be programmed remotely without a physical site visit.
- Monitors water use within individual systems and can detect and flag problems and pinpoint them for repair.



- Since the system is linked to a weather station, it can be automatically programmed to withhold water on rainy days.
- Remote systems can be automatically programmed not to water when soil moisture levels indicate water is not needed. These built in sensors can determine where water is being used and where there may be problems.
- Uses flow control monitoring devices that provide valuable data on water usage at each specific park or streetscape site.

Maxicom and IQ are the preferred central control systems for the majority of the city's park and streetscape sites. These systems requires daily monitoring by trained technicians who can make appropriate changes based on water use data and weather conditions. Since they are relatively complicated to operate, only sufficiently trained staff should program and operate centralized computer-controlled controllers. The use of a computer ET based system for medium to large parks and athletic fields is very important and should continue to be a high priority.

### **Installing Irrigation Systems**

All new irrigation systems and renovations shall be designed and installed according to departmental standard specifications and shall comply with the City of Bellevue's water efficiency standards and codes. In order to have water service (meter) provided, a water budget must be prepared and approved by the Utilities Department. To the extent possible, standardized material and products will be used to increase ease of maintenance and reduce inventory confusion and incompatibility problems.

### **Programming Automatic Irrigation Controllers**

Programming automatic irrigation controllers relies more on understanding a site and its plant materials than the mechanics of the system itself. Controllers should be checked bi-weekly to ensure proper operation to maximize watering efficiency. The primary goal of using automatic irrigation controllers is to maintain a consistent soil moisture environment that maximizes plant health and vigor while closely monitoring water use to minimize waste.

### **Water Auditing and Conservation**

As budget allows, the Parks Department may perform occasional water audits on existing systems to determine if water usage exceeds, meets or fails to meet the needs of plant species, soil types and weather conditions. In such cases, usage adjustments are made if a water audit shows that efficiencies can be gained with little or no impact to the plant resources.

During periods of drought, the City of Bellevue follows a water shortage management plan which is based on the voluntary curtailment of water usage by Bellevue residents, as well as a 50% reduction in normal irrigation usages on city property. For a detailed description of the City of Bellevue Parks & Community Services Department's Water Shortage Response Plan, see appendix. The Parks Department, in cooperation with the Utilities Department, also adheres to the City-wide Water Shortage Contingency Plan, adopted in 1994. Water restrictions are kept in effect until reservoirs are returned to safe levels and water quality testing has confirmed that the city's drinking water is safe for the public to consume.

### 4.3 Best Management Practices

Water use needs of the turf, shrubs and trees shall be researched prior to irrigation.

- Apply no more water each week than required to sustain healthy plants. For turf areas, a general rule of thumb is no more than 1 inch of irrigation water per week, including rainwater.
- Turf should be watered 1–3 times per week, and for longer periods if necessary, to promote deep rooting. Deep rooting leads to healthier, more drought-tolerant grass.
- Soil also plays an important role in irrigation. Soil conditions should be considered, particularly in turf areas with heavy use. Heavier, clay-type soils cannot be watered as long during each watering cycle as can sandy soils.
- Turf and planted areas should be aerated and cultivated to relieve soil compaction and increase water uptake.
- Whenever possible, watering should be avoided during the hottest part of the day. Watering at night is preferred to reduce water loss through evaporation and reduce potential vandalism to equipment and irrigation heads.
- Staff shall not allow manually operated systems to apply water longer than needed. For instance, the system shall not be turned on in the morning and turned off at the end of the day for convenience.
- Special attention shall be paid to verify that manually operated irrigation heads are watering the landscape and not hard surfaces or other non-landscaped areas.
- A water budget should be determined for each site.
- Depending on the availability of resources, a complete system audit should be completed on a 5-year cycle.

- Application of irrigation water shall be carefully monitored to determine when controller settings can be reduced to save water and to reduce runoff.
- A resource management system for irrigation operations should be developed. This system would provide a database from which programming records can be retrieved for annual system reprogramming to avoid starting from scratch.

### **Other considerations for Irrigation:**

- Consider plant species and age when programming the irrigation controller or when applying water manually.
- Site topography plays an important role in irrigation timing. Given their potential for runoff, sloped sites may require multiple applications of irrigation water in shorter timing cycles than required for flat sites.
- Parks staff should become familiar with site specific soil moisture holding capacities and soil infiltration rates.
- To help prevent overwatering and waste, staff should learn what the specific water requirements are of the plant material in each irrigation zone at any given park or streetscape site.
- Staff should become familiar with the attributes for each irrigation zone, such as slope, aspect, soil type and plant nutritional requirements.

### **Irrigation System Maintenance**

The following are preventive maintenance procedures for irrigation system operations:

- Visually check the system to make sure it is operating properly. This includes taking the time to make sure that rotary irrigation heads are rotating fully to the desired arc and adjusting as necessary.
- Perform regular preventive maintenance on heads, valves and controllers.
- Repair the system promptly to reduce water loss and damage to the landscape.
- Make sure heads are set at the proper grade and properly aligned.
- Make sure valves are operating properly.
- Use the system winterization and de-winterization processes as opportunities to make complete system visual checks.
- Keep grass and shrubs trimmed away from heads to allow proper functioning.
- Clean heads as needed to ensure optimum performance.

## Upgrades and Replacements

- An existing inventory of the condition of all managed irrigation systems shall be maintained and updated as required.
- A replacement program (major maintenance program) is needed to ensure timely upgrading or replacement of old and antiquated systems. This is currently achieved through the Parks & Community Services 7-year Renovation and Refurbishment Plan.

## 4.4 Training

Staff training is required in several areas:

### Basic Water Conservation

All park maintenance and operations staff should receive training on basic water conservation as part of an overall training program in environmental management. City staff, vendors or state agencies can provide this training. Staff should follow the Parks & Community Services Department drought policy during periods of extreme regional water shortages (see appendix).

### Electric Controllers

Programmers for the system are required to become familiar with the unique qualities of each controller. This training should be scheduled when controllers are installed or when staff are unfamiliar with equipment. Training should include all field staff.

### Maxicom & IQ

Operation of the Maxicom and IQ systems require training and certification. This training is typically provided by outside vendors.

(This page intentionally left blank)

## CHAPTER 5 – Nursery Operations



### 5.1 Purpose

The Bellevue nursery provides a cost-effective way for the Parks Department to meet landscape construction, restoration and plant replacement needs throughout the park and open space system. Parks staff follow strict operational procedures at this facility to produce and maintain high quality and healthy plants. This chapter identifies and defines these best management practices for nursery operations.

### 5.2 Background

The Parks Department operates a 5-acre nursery located at 15302 SE 16<sup>th</sup> Street within the Lake Hills Greenbelt. This facility holds ornamentals, groundcovers, vines, perennials, shrubs and trees that are procured from local nurseries and plant growers. These plants are stored at this facility to support various needs throughout the park system ranging from small in-house planting projects to large capital improvement projects.

An increasing number of these plants are Pacific Northwest native species that are grown for use in landscape renovation and open space restoration projects to ensure

variety of plants needed in the sizes required. The following are features of the City of Bellevue Nursery:

- Office and storage building
- Growing frames
- Holding and healing-in area
- Container yards
- Poly and shade houses
- Propagation areas: cold frames, seed beds, poly-house.
- Bulk material storage
- Equipment storage

### **Basic Operating Plan**

- Most of the nursery operation is containerized. Plants are grown and stored in containers of various sizes for eventual planting in parks. A containerized operation is both cleaner and less labor intensive than field growing, particularly when moving plants out of the nursery.
- Plants are field grown to meet specific needs such as large specimen trees.

### **Plant Selection**

- The City of Bellevue's nursery program is not designed to store or carry a large number of plants in its inventory. Surplus plants are not cost effective given the care required to maintain a large inventory.
- The types and quantities of plants selected for procurement and storage are generally determined through requests from Parks Department staff or to meet specific requirements of various capital projects.
- There are some plants that are grown occasionally as test subjects for possible introduction into park landscapes.

## 5.3 Best Management Practices

The following are standard practices for preparing and maintaining plants grown and/or stored in City of Bellevue nursery operations.

### **Site Preparation**

- All plant growing and storage areas shall have adequate drainage to ensure plants are not sitting in water or saturated soil.
- Field growing soil and imported potting soil shall be tested as needed to determine the need for amendments/nutrients and for the presence of unwanted pathogens.

- The container soil mix shall be compost (20%), peat (15%), pumice (25%) and fine decomposed bark (40%) with 1 lb. calcium nitrate added per cubic yard.
- Soil for field growing shall be a sandy loam with not more than 30% organic material in the form of equal parts of compost and bark (Note: bark in this case is fir or hemlock free of wood waste products. Cedar bark or chipping debris shall not be used).

### Site Maintenance

- Noxious weeds shall be controlled or removed from the site during preparation.
- Roads and pathways shall be maintained on an annual basis to ensure accessibility.
- Any exposed soils or bark piles shall be covered with plastic.
- The general public or contractors shall not have access to the nursery grounds unless a pre-approved department staff person is also present.

### Cultural Care

The following are preventive maintenance techniques the Parks Department uses to ensure the quality of its nursery plants.

- All plants should be spaced to allow for optimal growth, especially in field growing areas.
- Containerized plants shall be re-potted as needed to prevent encircling roots and to allow them to grow into their desired natural form without girdling.
- All plants shall be watered as needed. The primary method of irrigation is the existing overhead system. This system works well for field growing areas but is modified as needed for watering containerized plants.
- City water used for plant irrigation purposes shall be used efficiently:
  - Plants will be grouped by size and water needs.
  - Watering will be done on an as-needed basis.
  - The most efficient system for watering individual planted areas will be used.
  - Avoid watering nursery areas that are not currently holding plants.
- The nursery shall support recycling:
  - Clean compost will be used whenever possible.
  - Growing containers will be reused or recycled.
  - Plant debris will be sent to a "clean-green" yard waste facility.
  - Used soil from containers will be reused onsite whenever possible.
- Plants shall be fertilized as needed using slow-release types of fertilizers.



- Plant holding areas shall be used for plants that are in transition. While in holding, plants shall be mulched, staked as needed, watered and provided with shade protection if required.
- Winter protection shall be provided for plants as needed through the use of existing greenhouses or "frost blankets." Smaller, more tender plants shall have priority for winter protection.

### 5.4 Training

The City of Bellevue has developed a basic training program for staff assigned to work in the nursery. This training is also made available to other City of Bellevue staff to broaden their horticultural skill base.

## CHAPTER 6 – Planting Bed Management

---



### 6.1 Purpose

Landscape planting beds are often the focal point of a park, streetscape or city buildings. They provide color, texture, space definition, fragrance, wildlife habitat and other benefits enjoyed by park users. In the Pacific Northwest, climatic conditions favor growing a wide variety of ornamental landscape plants and a rich palette of Northwest native plants. These environmental conditions have allowed planners, designers and maintenance staff to create a landscape plant collection of real beauty. Careful management of these assets is required to continue the heritage and maintain the value of this substantial plant collection. The best management practices described in this chapter are applicable to parks, city buildings and streetscapes that have planting areas as a design function.

### 6.2 Background

Level of visibility and site use dictate maintenance standards for planting beds. Even within the same park, maintenance techniques can differ for formal plantings and high-traffic areas as opposed to remote areas that may remain informal and natural. For that reason, planting bed BMPs are tailored to the specific requirements of plant material and site goals. For example, at a formal site, the desired result may be to promote prolonged bloom in floral displays.

Planting beds can be divided into four categories according to level of visibility and usage:

1. Floral Beds are highly visible and have a high standard of maintenance which includes weekly grooming, weeding and regular site visits.
2. General Landscape Bed Areas have moderate visibility and standards of maintenance which include monthly weeding and seasonal pruning.
3. High-Visibility/Public Facility Landscapes have the highest visibility and the highest standard of maintenance.
4. Newly Established Landscapes will have a high standard of maintenance through the plant establishment period (1-5 years).

### **Existing Site/Environmental Conditions**

Site microclimate considerations are taken into account when planning a new planting or renovating an existing one. The following factors must be weighed:

#### **Current Landscape Condition**

The condition of current plant material is a good indicator of existing cultural conditions. Compaction, low nutrients and types of pest populations determine renovation and plant selection options. This is particularly true of soil-borne pathogens such as *Phytophthora* root rot. Selecting resistant plant materials is a must. It is also recommended to select plants that do not require fertilizers or highly specialized care.

#### **Soil Type and Condition**

Soil may require amendment to improve drainage or water-holding capacity. Heavy clay or very sandy soils may be improved if desired, but appropriate plant selection is vital to the success of the planting.

#### **Drainage**

Irrigation and drainage conditions must be assessed and any improvements included in the design process. Run-off should be eliminated as much as possible. If a site is or has a steep slope, COB standards must be met. (see *City of Bellevue Critical Areas Ordinances*)

#### **Cultural Conditions**

Cultural conditions such as exposure to sunlight and reflected light, heat, wind and rainfall apply to plant selection and irrigation installation.

#### **Safety**

Safety issues include falling branches, plant growth that blocks pathways, visibility through shrub beds, sightlines at park entrances, and rerouting pedestrian traffic to sidewalks.

### **Flowers**

In floral displays, the maintenance budget for the display must be taken into consideration when selecting plant material. Some annuals and perennials require more grooming than time constraints allow and should only be used where they will receive adequate care.

### **Species Diversity**

Species diversity offers a longer season of interest. Monocultures can be more susceptible to total failure in the case of insect or disease problems.

## 6.3 Best Management Practices

### **Site Preparation**

Preparing the site is important to the long-term success of a landscape. Making the necessary cultural improvements before planting saves time and money. The following are BMPs for site preparation:

#### **Existing Weeds**

To prepare a site for landscaping or renovation, existing weeds and undesirable plant materials should be removed as thoroughly as possible. Weed populations (especially difficult-to-control weeds such as horsetail, morning glory and quack grass) affect planting plans. In a primary bed location, they should be eradicated before installation of new landscapes. If mechanical eradication is not practical, appropriate chemical control will be considered.

#### **Overgrown Plants**

Plant material that is too large, or has an expected mature size that is too large for the space, should be replaced with appropriately sized species.

#### **Diseased Plants**

Disease and insect-resistant material should be selected and used where the culture will promote healthy growth. In an existing planting bed to be renovated, diseased plants shall be removed and replaced with healthy specimens or treated by appropriate means.

#### **Soil**

Soil amendments as required should be added to and incorporated into an entire planting area. Avoid tilling saturated soil, which can damage tilth. Providing adequate soil volumes for newly constructed park facilities and streetscapes is a key component of long-term landscape success.

### **Water**

Irrigation and drainage systems should be installed as needed.

### **Landscape Features**

Install retaining walls, pathways and hardscape features prior to plant installation to avoid subsequent damage.

### **Rocks and Debris**

Excessive rocks and debris must be removed. Rake area to establish finish grade.

### **Fertilizers**

A soil test indicates fertility levels in the soil. Fertilizer, if required, should be applied to the site and incorporated into the soil. Amendments that include un-composted woody material may require nitrogen.

### **Annuals**

Annual flowerbeds must be spaded or tilled at planting time. Amendments such as compost, sand or Perlite can be added to adjust drainage. In containers, the addition of hydrating gel can enable the use of plant material that might not otherwise be appropriate to water requirements.

## **Planting**

The following guidelines for proper installation of plant material ensure good establishment and healthy growth.

### **Fertilizer**

If fertilizer is to be used, it is best to wait until plants are established before adding chemical fertilizers to the soil in order to promote long root growth.

### **Depth**

Plants must be placed at proper depth, taking into consideration the space needed for mulching.

### **Spacing**

Proper spacing with consideration of mature size and spread of plants ensures good establishment. Good air circulation and availability of sunlight, water and nutrients will promote growth and avoid development of disease. Groundcovers and floral plantings should be close enough to provide adequate coverage to compete with weeds and provide effective display without being too crowded at maturity.

### **Water**

Water new plantings to settle soil and reduce transplant shock. Ensure adequate moisture levels during the growing season.

**Mulch**

Mulch at planting time for maximum efficiency. Rake soil smooth to prevent puddling and then apply mulch. Avoid smothering small plants. A fine mulch is preferred as it will become the next season's planting soil.

**Edging**

The main purpose of edging is to maintain an attractive, manicured edge to the planting bed area. Proper edging also controls weeds along the edge of the planting bed.

- Informal plantings can be maintained mechanically or chemically to control turf and weed encroachment onto mulched areas.
- Formal plantings can be maintained by hand tools, mechanical means or chemically.

**Irrigation**

Site conditions such as soil type and slope, exposure and moisture requirements of plants dictate both frequency and duration of application.

- Weather conditions, such as temperature and rainfall, require monitoring and response. Generally, most plants require at least 1 inch of water per week. Drought tolerant plants, once established, may need less. Floral plantings, particularly in containers, require considerably more.
- Infrequent deep watering is preferable. Avoid creating runoff.
- Shrubs, groundcovers and flowers planted in the root zones of large trees need more water to balance the competition from the tree roots.
- Consider pedestrian access, park usage and available personnel when establishing irrigation schedules.
- Avoid disease damage by keeping water off of leaves.
- Be sure to begin watering early enough in the spring to prevent plant stress and hydrophobic soil conditions. Continue irrigating until consistent fall rains begin.
- Visually test and monitor the system weekly.

**Mulching**

Mulching serves to conserve moisture, retain soil, suppress weed growth, moderate soil temperature, reduce compaction and supply nutrients for plants and soil microbes. Mulch is also aesthetically pleasing making it desirable for highly visible locations.

- Materials include bark products, compost, wood chips and other commercial organic products.

- Depth of application varies according to type of plant material, but averages 2 to 3 inches. Keep mulch materials away from contact with trunk or root crown of plants to avoid stem rot.
- Recess edge of beds to avoid drift of mulch materials onto turf or pavement, where necessary.
- Flowerbeds should be mulched with a fine material such as compost, taking care not to smother plant crowns. Generally, mulch in an annual planting is 1 inch deep although a deeper layer of mulch, if possible, will provide better weed suppression.
- Un-composted woodchips can potentially deplete soil nitrogen as they decompose. The use of woodchips may require application of a nitrogen-rich fertilizer.
- The use of fallen leaves as mulch may be appropriate in some areas. Avoid using diseased or insect-infested material. It is important to avoid smothering the roots of the desirable plants with too thick of a layer. A 2-inch layer is considered best. Compost from plants that are known to be diseased shall not be used for mulching purposes.

### Fertilizing

Fertilizing, the use of organic or inorganic compounds, shall be tailored to specific requirements for plantings:

- Nutrients: Nutrient requirements differ according to plant type and the desired performance of a plant. Turf grass and showy ornamental plants require more nitrogen than plants grown specifically for flower and seed production. Plants grown for flower and seeds require more phosphorus (P) and potassium (K). Too much nitrogen can cause excess growth, which will be more susceptible to insect and disease damage.
- Application Timing: Timing application to the biological cycle of the plant is important in maintaining optimum growth. Plants just becoming established may require more P and K in the blend to encourage root development. Also, plants benefit most from fertilizer application at the onset of their new growth in the spring. Applications too close to fall may delay dormancy and promote soft growth, which can suffer winter damage.
- Micronutrients: Micronutrients are also important for plant health. It is best to test the soil to determine existing levels of these nutrients because an imbalance can harm plants.
- Soil pH: The pH of the soil will determine whether to use an acid or base formulation of fertilizer, as well as the need for lime applications. Always test for pH before applying any fertilizer or lime.

- **Formula:** Select a formulation that is best for the soil type and time of year. Cold weather slows the activity of soil microbes that make nutrients available to the plants. Plants require nitrogen, phosphorous, potassium and other nutrients to optimize growth.
- **Floral Plantings:** Floral plantings can be fertilized at planting time with slow-release fertilizer. Flowers can also be supplemented during growing season with foliar feedings of liquid fertilizer.
- **Compost:** Compost can be applied as a nutrient source. It must be fully decomposed so that nutrients are made available to plants. Most compost has no more than 3% nitrogen, which is slowly released. Its main benefit is that it encourages beneficial soil microbial growth.

## Pruning

Pruning shall be performed according to current ISA and ANSI A300 standards and for the following reasons:

- Encouraging and directing new growth and flowering.
- Removing spent blooms and foliage.
- Removing insect, disease and weather damage.
- Maintaining size and shape.
- Maintaining visibility.
- Improving safety.
- Creating pedestrian and mower access.

## Plant Selection

Use appropriate plant materials that grow to the correct size for the space. Plant selection reduces the need for excessive pruning.

## Natural Form

A natural form is desirable in most park settings. This is also healthier for the plant and requires fewer pruning frequencies.

## Hedge Pruning

Hedge pruning requires careful timing for optimum results:

- First cut should be made as new growth begins to harden off.
- Last hedging should be made no later than mid-August.
- Hedges should be wider at bottom than top.
- Hedge pruning is labor-intensive and is best applied to plants with smaller leaves as they tolerate heavy pruning better.
- Because the intensity of maintenance required, formally-pruned hedges are not desirable in many park locations.



- When major pruning is required of prominent plantings and hedges, neighbors/park users may need to be notified in advance of the work to be done.

### **Timing**

The best timing of pruning for most plant material is following flowering. Workload balancing, however, often dictates dormant season pruning.

### **Growth Habit**

The growth habit of specific plant material will determine optimum pruning method.

## 6.4 Training

Training in IPM alternatives for planting bed maintenance will be provided to field staff. Staff will receive ongoing training in:

- Basic horticulture care
- Growth standards
- Plant identification
- Soils
- Chemical application

# CHAPTER 7 – Turf Management

---



---

## 7.1 Purpose

Turf provides a forgiving and resilient surface for many recreational activities and is the traditional "green carpet" that visitors associate with parks. Because turf varies substantially in use, so do turf management practices. Appropriate management ensures high quality turf where it is needed, such as on athletic fields and golf courses, and that the designed use of a site is met. The best management practices described in this chapter for turf management would also be applicable for city streetscapes with turf as a component of the landscape.

## 7.2 Background

The park system offers visitors a wide variety of turf, including lawns (both formal and informal), athletic fields, golf courses and meadows. Each type of turf requires a separate best management practice. The intensity of management ranges from very highly maintained golf course turf to meadow areas that may get mowed only once a year as a fire prevention measure.

## Construction Issues

- Turf areas should be constructed with a minimum slope of 2% to promote surface drainage and a maximum of 15% to allow riding mowers to safely access the areas.
- Whenever possible, the existing soil should be amended with sand and a minimum of 6" of topsoil to provide a drier surface area. Dry areas allow easier and earlier (in the mowing season) maintenance.
- Trees, signposts, benches and other park amenities should be carefully placed in turf areas to reduce the need for hand trimming. If possible, these amenities should have the turf immediately surrounding them removed (such as for a tree ring) to protect the amenity and to facilitate more efficient turf care.
- Whenever possible, seeding should occur during the spring or fall months to insure maximum germination.
- Design a natural buffer area (no pesticide or fertilizer use) between turf and water bodies or drainage systems. If possible, this buffer should be at minimum 50 feet.

## Plant Selection

Selection of grass species is based on site conditions, expected usage and maintenance standards. Sites with optimum growing conditions and high maintenance standards are seeded with blends of several species of perennial rye grass. Sites with poor drainage, partial shade and limited fertilizer applications require blends of perennial rye grass and red fescues.

## 7.3 Best Management Practices

The following BMPs apply to all City of Bellevue turf plantings. Some variations may apply to golf course turf.

### Mowing

#### Frequency

The importance of regular mowing for promoting healthy turf cannot be over emphasized. Growth should be monitored, and frequency increased to avoid removing more than 1/3 of the leaf blade. The following is the basic standard for mowing frequency:

Season	Frequency
March - October	Weekly
February & November	Monthly or as needed
December	As needed

### Cutting Height

Mowing height should be 2 to 2.5 inches to promote healthier turf. Lower cutting height often results in scalping spots where the ground is uneven.

### Mulch Mowing

Grass clippings should rarely be removed from mowed turf areas. The plant nutrients and organic material they contain play an important role in developing a healthy, productive environment for root growth. Mulch mowing can also reduce the need for supplemental fertilization.

- Mowing patterns should be alternated to avoid ruts and compaction from the wheels.
- Avoid driving on frozen turf.
- Avoid driving on wet ground where ruts will remain. Walk the site during wet conditions to do a visual inspection.
- Mowing equipment must be maintained regularly, especially sharpening and adjustment of cutting edges.
- Ensure that grass clippings do not have the potential to be washed into stream or drainage systems which can degrade water quality.

### Trimming

- Trimming shall be performed by walk behind mowers and line trimmers in areas that cannot be accessed by riding mowers.
- Trimming should be coordinated to coincide with other mowing activities on the site.

### Edging

- Edging shall be performed a minimum of 2 to 4 times per year, depending on the maintenance standard for the site. Turf edging is done to give a finished look to lawn areas that border paved surfaces or planting areas and help reduce encroachment of grass into adjacent planting areas.
- At high visibility locations, edging shall be performed at a higher level of frequency.
- Edging should be performed with metal-bladed equipment whenever possible to prevent damaging turf edges.

## Irrigation

- Automatic irrigation effectiveness shall be monitored on a weekly basis or more for sand-based fields. During periods of extreme heat or prolonged drought, daily monitoring may be required. Spot watering may be done during the day to help wilting turf recover during periods of extreme heat.
- Approximately 1 inch of water, including rainwater, shall be applied per week. During spring rainy seasons, irrigation techniques should be modified to fit the weather, as well as in the summer drought months. Theoretically, the irrigation cycle should be extended to the point just before drought stress occurs. This period varies with soil conditions, weather, site usage and maintenance practices.
- Irrigation should be scheduled to promote deep root growth. A general rule of thumb to promote deeper root growth is providing deep and less frequent watering (typically 2-3 times weekly).
- Tools such as soil probes or moisture meters may be used when necessary for greater precision on determining soil moisture levels.
- Irrigation valve boxes should be edged on a regular basis to prevent being overtaken and eventually covered by encroaching turf.
- Irrigation heads should be edged and cleared of turf as needed to ensure proper function and water distribution.

## Fertilization

- In general, fertilizer blends containing phosphorus (P) are prohibited. The only exception may be when establishing newly seeded turf.
- Fertilizer shall be a slow-release compound of Nitrogen (N), Iron (Fe) and Potassium (K). The ratio is dependent upon the time of year.
- Fertilized turf shall be pH soil tested as necessary to ensure it is at the level most optimal for nutrient absorption.
- Each application should not exceed 1 lbs. of N per 1000 square feet.
- Applications during heavy rainfall shall be avoided to prevent runoff.
- Applications in very hot weather shall be avoided.
- Irrigation should be operational before growing season applications.
- Irrigation heads should be marked to avoid damaging them during tractor applications.
- Excess fertilizer shall be removed from hard surfaces immediately.
- Micronutrients and lime should be added, as soil tests indicate.
- Site-specific fertilizer restrictions must be observed. Site-specific cautions include not using any fertilizer on turf areas adjacent to streams and wetlands and prohibiting applications within 50 feet of lakes and waterways whenever feasible.

## Aeration

- Aeration is a low cost, effective way to reduce soil compaction and enhance drainage in highly used turf areas (e.g. soccer goal areas, sidelines) and opens up the soil profile for enhanced water and fertilizer absorption.
- Aeration shall be done 2 to 3 times per year, or as needed, using .75-inch hollow or solid tines.
  - Best periods: March/April, late June and late August.
  - Technique: Make at least 2 passes at 90-degree angles.
- Areas with drainage problems should be deep-tine aerated 1-2 times per year using 1-inch-by-6-inch hollow or solid tines.
- Irrigation heads should be marked to avoid damaging them with aeration equipment.

## Top Dressing

General-use top dressing mix shall be used and should be primarily sand with minimal organic matter. It is best to aerate turf areas prior to topdressing operations.

- Frequency: most effective when done lightly and frequently.
- Each application should be about ¼ inch.
- Heavily top-dressed turf areas may require floating with a boxed float and/or drag mat to shave down high areas and fill in low areas to create a consistent, uniform surface.

## Overseeding

Heavily impacted areas should be overseeded at least once per year. The best practice is to overseed in fall and slice seed in spring at a rate of 5 lbs. per 1000 ft<sup>2</sup>. The following site characteristics, usage and maintenance practices shall guide seed selection:

- Ideal sites with full sun, good drainage and reasonable fertility are suited for perennial ryegrass blends.
- Turf areas that are in partial shade or poorly drained soils should be seeded with mixes of perennial rye and fescues.
- Remove leaves and debris from turf areas prior to overseeding.
- Keep leaves and debris off turf areas as much as possible after overseeding to promote successful germination of grass seed.

### Site Standards

Site standards for turf vary by landscape classification. Landscape classifications include prominent, general and non-irrigated lawn areas, steep slopes, meadows, soil or sand based athletic fields, synthetic athletic fields and bathing beaches.

#### Prominent Irrigated Lawn Areas

These are high-visibility or high-use landscapes. Some examples are community center lawns, popular picnic or sunbathing areas, lawns adjacent to busy arterials, beach parks, city buildings, community parks and the Bellevue Botanical Garden or smaller neighborhood parks where the lawn is the most significant amenity. Maintenance of these areas should be comparable to an athletic field with additional emphasis on trimming and edging.

- Soil shall be pH tested to determine liming/gypsum requirements. The soil analysis test shall be used to determine fertilizer requirements.
- The application of lime and gypsum products can be used to adjust the pH level in soils to make nutrients more readily available. A pH range of 6.5-7.5 is most ideal for turf areas. Adding more nutrients through fertilization to soils with pH outside of this range is ineffective and wasteful.
- Apply N-K ratio fertilizer at 3 to 5 lbs. N per 1,000 ft<sup>2</sup>, in 2-3 applications annually.
- Soil aeration should occur 2 to 3 times per year with conventional 0.75-inch hollow tines.
- Overseed the entire lawn at least once per year at 5 lbs. per 1000 ft<sup>2</sup>. Monthly applications should occur in high-use areas.

#### General Irrigated Lawn Areas

These are lawn areas in parks of various types where irrigation is available.

- Apply N-K ratio fertilizer at 1 to 2 lbs. N per 1000 ft<sup>2</sup>, in 1 to 2 applications annually. Preferable fall N-K ratio is 15-0-31 with 6% iron and preferred spring N-K ratio is 22-0-22 with 6% iron.
- Soil aeration should occur 1 to 2 times per year with conventional 0.75-inch hollow tines.
- Overseed as needed. Overseeding is best done in April/May and October.

#### Non-Irrigated Lawn Areas:

These are lawn areas in parks of various types where irrigation is not available.

- N-K fertilizer should be applied once annually in late spring.
- Overseed as needed. Overseeding is best done in April/May and October.

### Steep Slopes

Mowing and maintaining turf on steep slopes can be hazardous. Whenever possible, turf areas on steep slopes should be converted to planting beds. This will greatly reduce maintenance needs and reduce the risk of accidents with mowing equipment. When turf is required on a steep slope, the following management practices should be followed:

- Growth should be controlled mechanically with line trimmers.
- Turf growth regulators should be considered to reduce required trimming frequencies.
- If feasible, consider managing turf on steep slopes as meadows which only require 1 or 2 mowing frequencies per year for fire suppression.

### Meadows

Meadows are unique environments that function primarily as wildlife habitat.

- Mowing should be infrequent with the goal being brush suppression and fire control. Analyze site for potential fire threat and fire control strategies.
- Whenever feasible, mowing should be done prior to the emergence of pollinators so not to disrupt local colonies.
- When timing out maintenance frequencies, keep in mind that successful establishment of native species requires that they have the opportunity to set and release seed before mowing.
- Site access routes should consider maintenance, interpretive value and habitat preservation.
- Species selection should be matched with existing available groundwater.
- Location of meadow should attempt to link other wildlife areas into larger contiguous habitat areas.
- Scheduling and timing should minimize impacts to wildlife nesting and habitation.
- One mowing every 2 to 3 years may be sufficient for woody brush control. Firebreak areas may require more frequent mowing to maintain.
- Mowing heights should be 3 to 5 inches.
- Refer to Chapter 9, Trees & Natural Area Management, for additional BMPs regarding meadows.

### Soil-Based Athletic Fields

These athletic fields are generally composed of native soil formed onsite with minimal amendment. These facilities are characterized by scheduled play. Drop-in fields are maintained as general irrigated lawn unless there is exceptionally high usage.



- Soil shall be pH tested to determine liming/gypsum requirements. The soil analysis test shall be used to determine fertilizer requirements.
- N-K fertilizer shall be applied at a ratio of 2 to 6 lbs. of N per 1,000 ft<sup>2</sup>, in 3 to 4 applications annually.
- Soil aeration should occur 4 times per year with conventional 0.75-inch hollow tines. Fields should be aerated with deep tines every 1 to 2 years.
- Overseed the entire field at least once per year at 5 lbs. per 1000 ft<sup>2</sup>, or about 375 lbs. per soccer field. Monthly applications should occur in heavy wear areas, such as the goalmouth, during the playing season.

### **Sand-Based Athletic Fields**

These fields are entirely composed of imported sand and are known for their increased drainage capability.

- Irrigation shall occur more frequently than on soil-based fields.
- Apply N-K ratio fertilizer at 3 to 6 lbs. of N per 1,000 ft<sup>2</sup>, in 6 to 8 applications annually, depending on turf type and time of year.
- Soil aeration should occur 2 to 3 times per year with conventional 0.75-inch hollow tines. Deep-tine aerating (6" +) should also be done every 2 to 3 years.
- Overseed the entire field or ballfield at least once per year at 5 lbs. per 1000 ft<sup>2</sup>, or about 375 lbs. per soccer field. Monthly applications should occur in heavy wear areas, such as goalmouths, during playing season.

### **Bathing Beaches**

- Apply 2 to 6 lbs. of slow-release N fertilizer per 1,000 ft<sup>2</sup>, in 2 to 3 applications annually.
- Special care should be taken to not fertilize in advance of heavy rains or before expected periods of heavy park usage.
- Soil aeration should occur 2 to 3 times per year with conventional 0.75-inch hollow tines.
- Overseed the entire lawn at least once per year at 5 lbs. per 1000 ft<sup>2</sup>. Monthly applications should occur in heavy wear areas.

### **Synthetic Turf Athletic Fields**

Since 2008, many of the higher use athletic fields within the park system have been converted from natural turf fields over to synthetic turf fields. Although this conversion reduces and/or eliminates the need for applying supplemental irrigation, aerating, fertilizing and overseeding, synthetic fields still require a high level of maintenance to keep them safe and usable for the public. Maintaining a synthetic turf field is essential for optimum appearance, safety, performance and field longevity. Maintenance of a synthetic field typically consists of cleaning, stain

removal, minor seam repair, grooming, infill material redistribution and management of infill compaction. A regular maintenance schedule should include:

- Debris removal: Daily
- Aggressive surface cleaning: Biannually
- Grooming: Monthly
- Infill replenishment/redistribution: Weekly for high traffic areas on synthetic baseball infields, monthly for all other sports.
- Decompaction: Monthly

The synthetic turf manufacturer/installer should provide detailed written maintenance instructions, suggested warranty guidelines and training of maintenance personnel.

## 7.4 Training

- All park maintenance field staff should have training in basic turf management.
- Mowing operators have specific training regarding mowing heights, patterns and equipment maintenance.

(This page intentionally left blank)

# CHAPTER 8 – Streetscape Management



## 8.1 Purpose

The Street Tree and Arterial Landscapes program currently maintains 200 acres of formal landscaping and over 10,000 street trees in the public right-of-way. For these landscapes to be successful, they must be thoughtfully designed and constructed, meeting stringent safety requirements and aesthetic standards. Once installed, skilled maintenance supports plantings to maturity and increases their value to the public. The Best Management Practices described in this chapter are intended to help streetscapes reach their potential, support city livability policies and contribute to Bellevue's image as a "City in a Park."

## 8.2 Background

There are three types of right-of-way vegetation identified for the City of Bellevue: formal arterial landscapes, residential landscapes and informal roadside vegetation. The Parks & Community Services Department accepts management responsibility for most formal arterial landscapes, also known as "streetscapes". Streetscapes are landscape improvements in urban centers and along arterial streets. These landscapes require an effective and efficient maintenance program to deliver a high level of value to the community. This chapter describes Parks & Community Services Department maintenance responsibilities for designated streetscapes and not for

other types of right-of-way landscaping that may be the responsibility of other city departments or private property owners. This chapter gives design guidance that is useful for all formal landscaping in the right-of-way.

Attractive roadside landscaping improves livability within our community and contributes to the experience of Bellevue as a “City in a Park”. Streetscapes engage pedestrians, provide connectivity for the Parks system and improve the roadway experience for everyone. Nearly 40 years of scientific research documents the positive impact that green infrastructure has on local economies, mental and physical health, public safety and worker productivity.<sup>1</sup> Green infrastructure supports ecosystem services, improves water and air quality and mitigates urban heat island effects. Developing and maintaining safe, attractive and sustainable streetscapes serves important public needs, manages assets wisely and enhances the character of adjacent uses.

### Policy Overview

The practices described in this chapter implement policies set out in a variety of planning initiatives and city codes, including but not limited to the [City of Bellevue Comprehensive Plan](#), the [Bellevue City Code](#) (BCC), and the City of Bellevue [Land Use Code](#) (LUC).

### Comprehensive Plan

The Comprehensive Plan is a foundational document that sets out the community’s vision for the future, lays out a groundwork of planning policies to guide city actions and provides a framework so that city departments and community organizations work together toward common goals.

**Table 8.1**

Streetscapes are supported by policies defined by the *City of Bellevue 2015 Comprehensive Plan*.

<p>Environmental Element: Policies 12, 13, 24, 45, 46, 49, 71, 97</p> <ul style="list-style-type: none"> <li>• Establishes a 40% citywide tree canopy goal</li> <li>• Promotes preservation of significant trees and canopy loss mitigation</li> <li>• Supports Low Impact Development (LID)</li> <li>• Directs the city to pursue integrated site planning early in project development</li> </ul>
<p>Land Use Element: Policies 2, 13, 32, 33</p> <ul style="list-style-type: none"> <li>• Directs city to preserve existing tree canopy</li> <li>• Acquire and enhance landscaped areas to improve livability and neighborhood character</li> </ul>
<p>Parks, Recreation &amp; Open Space Element: Policies 31, 33</p> <ul style="list-style-type: none"> <li>• Directs city to manage street tree resources for long-term vitality</li> <li>• Calls for conserving resources through efficient maintenance and operational procedures</li> </ul>

<sup>1</sup> For more information visit *Green Cities: Good Health* at <http://depts.washington.edu/hhwb/>.

Transportation Element: Policies 51, 111, 139, 144

- Provides sufficient space in the right-of-way for trees and landscaping
- Recognizes the health benefits of walking and bicycling
- Protects and enhances the natural and built environment

Urban Design & the Arts Element: Policies 2, 4, 12, 37, 38, 42, 44, 47, 54-57, 64-71, 74-76

- Promotes the quality and safety of urban environments through the preservation and enhancement of trees, species selection, low-impact development standards, and site design
- Directs use of landscaping to minimize impacts to neighborhoods
- Promotes water conservation through irrigation system design
- Directs city to provide adequate rooting space for trees

### Bellevue City Code and Land Use Code

Parks & Community Services may accept responsibility for maintaining streetscapes in the right-of-way, but unless a maintenance agreement exists, responsibility for maintaining landscaping within the right-of-way and easements belongs to the abutting property owner. Compliance with the provisions of the following ordinances is expected:

- Property owners are responsible for maintaining all landscape materials in the right-of-way to industry standards as described in Section 8.3, unless that responsibility has been formally accepted by the City of Bellevue. *BCC 14.06.100 and BCC 14.60.120*
- Trees and landscaping along street frontages may be required to be retained and maintained even if these amenities are on private property. *BCC 14.60.110 and 14.60.120; LUC 20.20.520 and 20.25.060*
- Property owners are responsible for ensuring that landscaping fronting their property does not obstruct driver or pedestrian sight distance as described in the Transportation Department Design Manual. *BCC 14.60.240*
- Illegal clearing, cutting, damaging, topping, pruning that is not in accordance with industry standards, or removing of street trees is a civil violation and subject to monetary penalties. *BCC 1.18.045, 3.43.335, and 14.60.040*
- All work in the right-of-way is subject to Right-of-Way Use Permits and may require Clearing and Grading Permits. To learn more about the permitting needs for your project, call Service First at 425-452-6800.

### Technical Standards Overview

In addition to the City of Bellevue Codes and Policies described above, this chapter makes reference to outside documents and technical standards for tree and landscape maintenance, labor, materials and regulatory compliance.

#### Landscape Maintenance

- ANSI A300 – Industry Standards for Tree Care Practices (American National Standards Institute accredited)

- ANSI Z133 – Safety Requirements for Arboricultural Operations

### Materials

- ANSI Z60.1 – American Standard for Nursery Stock
- WSDOT Standard Specifications for Bridge, Road and Municipal Construction 2024
- US Composting Council – Definition of Compost
- Code of Federal Regulations Processes to Further Reduce Pathogens

### City of Bellevue Standards

- [CoB Transportation Design Manual](#)
- [CoB Utilities Department Surface Water Engineering Standards](#)
- [CoB Utilities Department Storm and Surface Water Maintenance Standards](#)

### Street Tree Selection Considerations

The Street Tree and Arterial Landscape workgroup within the Parks & Community Services Department maintains over 10,000 trees, comprised of over 250 different species and cultivars, in formal arterial landscape areas. Parks staff assist other departments within the city to evaluate existing trees in the right-of-way and select tree species for new plantings.

### Tree Selection Criteria

Appropriate tree selection adds to neighborhood character, minimizes conflicts with other infrastructure, ensures adequate clearance over sidewalks and streets, reduces impacts from pests and disease, and helps to soften the transition between urban spaces and Bellevue’s natural forest setting.

Trees should be selected for growth characteristics, site adaptation, design objectives and the amount of care they will require. Parks staff emphasize the selection principle, “the right tree for the right place.” The following criteria will be considered in tree selection:

- Environmental conditions
  - Soil type
  - Drainage
  - Sun exposure
  - Availability of water
  - Wind
  - Reflected heat
  - Pollution
- Spatial constraints
  - Overhead utilities or structure
  - Underground utilities or structure
  - Adjacent land use

- Sight distance
- Soil volume
- Desired botanical characteristics
  - Mature size
  - Branching structure and form
  - Flowers
  - Leaf color
  - Bark texture
- Pest and disease resistance
- Availability of nursery stock

**Designated Street Trees**

The goal of designating street trees is to define neighborhoods and create cohesive corridors. For some neighborhoods of Bellevue, street tree selection is designated by the Land Use Code. In Downtown, new street trees shall conform to LUC 20.24A.060 Plate B. In the BelRed Subarea, street trees shall be selected according to LUC 20.25D.110 and the BelRed Streetscape Design Guidelines. Small, medium and large categories of trees are identified in order to provide appropriate options for varied site conditions. Sometimes when a streetscape is renovated or redeveloped, existing trees at the site do not conform to the selection in Code. In these cases, retention of healthy mature trees is prioritized as much as possible.

Outside of certain SubAreas, the selection of tree species or cultivars is not specified in Code. The Parks & Community Services Street Tree & Arterial Landscape program manages a comprehensive list of existing trees and makes recommendations based on performance and availability for development on a case-by-case basis. The nursery industry adapts to changes in demand, introduction of new cultivars and species, and novel pests and diseases. Parks staff follow trends in nursery stock availability and are able to recommend species and cultivars to meet a wide range of selection criteria.

**Trees Not Recommended for Any Site**

Due to susceptibility to pests or disease, the following trees are not recommended for planting anywhere in this region and often require removal and replacement.

Botanical Name	Common Name	Issue
Betula species	Birch species	Bronze birch borer. Betula nigra 'Cully' is resistant and may be used.
Fraxinus species	Ash species	Emerald ash borer
Populus nigra	Lombardy poplars	Vulnerable to fungal leaf spot



### Invasive Trees Recommended to Avoid

Invasive species may propagate to areas outside of their intended locations and should be avoided if possible.

Botanical Name	Common Name	Issue
<i>Acer platanoides</i>	Norway maple	Self-seeds into natural areas, over-represented in Bellevue's urban forest inventory
<i>Ailanthus altissima</i>	Tree of Heaven	Class C Noxious weed
<i>Crataegus monogyna</i>	English hawthorn	Class C Noxious weed
<i>Ilex aquifolium</i>	English holly	King County weed of concern
<i>Prunus laurocerasus</i>	English/Cherry laurel	King County weed of concern
<i>Robinia pseudoacacia</i>	Black locust	King County weed of concern
<i>Sorbus aucuparia</i>	European mtn. ash	King County weed of concern

### Trees Not Recommended for Streetscapes

Sites adjacent to the roadway have constraints that should be considered in the selection process. The following trees are not recommended for streetscapes or sites adjacent to homes or infrastructure.

Botanical Name	Common Name	Issue
<i>Acer macrophyllum</i>	Bigleaf maple	Decay/other issues increase hazard potential
<i>Acer saccharinum</i>	Silver maple	Weak branches increase hazard potential
<i>Alnus rubra</i>	Red alder	Decay/other issues increase hazard potential
<i>Amelanchier</i> species	Serviceberry	Vulnerable to rust diseases
<i>Cupressus leylandii</i>	Leyland cypress	Canker diseases west of the Rockies; vigorous growth creates hazardous obstructions
<i>Pinus nigra</i>	Austrian pine	Vulnerable to <i>Dothistroma</i> needle blight
<i>Pinus ponderosa</i>	Ponderosa pine	Vulnerable to <i>Dothistroma</i> needle blight
<i>Populus tremuloides</i>	Quaking aspen	Decay/other issues increase hazard potential
<i>Populus trichocarpa</i>	Black cottonwood	Weak branches increase hazard potential; rapid trunk growth may damage infrastructure
<i>Prunus laurocerasus</i>	English/Cherry laurel	Vigorous growth creates hazardous obstructions
<i>Prunus</i> tree species	Flowering cherry	Susceptible to fungal diseases
<i>Pyrus</i> tree species	Flowering pear	Susceptible to fungal rust diseases
<i>Salix</i> species	Willow species	Decay/other issues increase hazard potential

### Soil Volume Standards

Urban environments present unique conditions for tree planting. Structures, utilities and competing uses for right-of-way place constraints on the available volume of soil. However, providing ample volume supports the growth of large healthy shade trees that provide maximum environmental benefits without damaging adjacent hardscapes. Minimum soil volumes for street trees in the Downtown SubArea are specified in LU Code 20.25A.060, which requires that all new development shall provide a defined volume of soil growing medium where street trees are planted.

### Soil Volume Standards

Soil volume standards are based on the mature size of the tree. Providing the following minimum soil volumes for all new trees is recommended:

- 500 ft<sup>3</sup> : Small trees (10-25ft crown spread, ~8" mature DBH)
- 1000 ft<sup>3</sup> : Medium trees (25-35ft crown spread, ~16" mature DBH)
- 1500 ft<sup>3</sup> : Large trees (35+ft crown spread, ~24" mature DBH)

The total soil volume requirement may be reduced by 30% for trees that share soil, such as with continuous planting beds.

### Definitions & Rules for Calculating Soil Volume

The following definitions apply to soil media for trees in the City of Bellevue:

- Open soil exclusively refers to either uncompacted native soils (no greater than 80% Proctor) or amended soils meeting the standards for approved "Type A" topsoil.
- Available open soil is the length by width of a planting bed, multiplied by depth of preparation up to 36 inches deep. Most unprepared urban subgrade is highly compacted and does not qualify as available.
- Covered soil refers to soil volume provided below hardscape or paved surfaces in the form of soil cells or structural soil. Only 25% of the volume of structural soils may be counted.
- Shared soil refers to more than one tree in a planting bed sharing open soil, or an individual tree in a planting bed that is connected to other open soils via Soil Cells or Structural Soil. Areas of shared soil must have continuous root path that does not restrict to less than 4 feet wide or 2 feet deep.
- Isolated soil refers to a tree well or small enclosed planting bed that is not connected to other prepared soil volumes and is totally isolated by hardscape such as driveways, sidewalks or vaults.
- Connected soil refers to two areas of open soil that are connected below hardscape with either soil cells or structural soil. These connected beds can now qualify as shared soil.

The following standards and exceptions apply to calculating soil volumes:

- The total soil volume provided for a tree shall be calculated in cubic feet by adding the available open soil volume to the available covered soil volume within a 50-foot radius of the tree.
- When total soil volume consists of more than one planter bed or open soil area, those areas must be able to be connected by continuous root paths at least 4 feet wide and 2 feet deep.

- Soil volumes for covered soil shall be calculated by using only the space available to soil and may not include the components providing structure. For example, the space occupied by modular decking in a soil cell system and the large aggregate in structural soil are not accessible to tree roots. Only 25% of the total volume of structural soil may be used for covered soil volume calculations.
- Required soil volumes may be reduced up to 30% for trees sharing a continuous planter strip of at least 4 feet in width, or when soil cells form a direct path between planter pits. For example, the total required soil volume for large trees planted to this standard would be 1050 ft<sup>3</sup>.

### **Irrigation Design Standards**

Approximately 2,250 irrigation zones and 90,000 sprinkler heads deliver water to the streetscapes that Parks & Community Services manages. Regular maintenance of these systems is cost and resource efficient. Adjustments should be made to accommodate for species needs, seasonal weather and climatic variation. See Chapter 4 – Irrigation and Water Management for more information on equipment standards and BMPs.

Installation of irrigation may be required as a part of street frontage improvements (BCC 14.60.110B). Irrigation installations in the right-of-way shall meet all of the following requirements:

- Low volume efficient spray systems are required within the right-of-way. Use of drip irrigation should be limited to narrow beds under 3' wide.
- Two tree root watering bubblers should be installed for each new tree. Trees shall be on a separate zone from turf or formal landscape beds.
- If trees are installed adjacent to soil cells, a drip watering system with accessible connections within planter shall be installed in the cell area. See drawing PK-IM-07H Drip Irrigation at Tree Soil Cells.
- A separate meter and controller dedicated to right-of-way irrigation shall be installed at a location determined in consultation with Parks staff.
- City staff must have 24-hour access to the meter and controller.
- Right-of-way irrigation shall use a smart controller that can incorporate evapotranspiration information or sensors to initiate, adjust or suspend irrigation to meet plant water needs and maximize efficiency.
- 6" diameter sleeves shall be installed under all sidewalks and driveways.
- Schedule 40 irrigation pipe is required. Use of class 100 and 200 irrigation pipe is prohibited in the right-of-way.
- Installation and repair shall be performed by experienced or certified irrigation professionals.

- All work on new or existing irrigation systems supplying water to landscaping in the right-of-way shall be inspected and tested by city staff before it is covered by soil.

**Materials Standards**

**Plant Quality, Approval and Care**

Careful attention during plant installation can prevent common issues that lead to increased maintenance costs. The quality of each plant should be visually checked either at the nursery before shipping or at the time of delivery. Plants should exhibit good form, vigor and shape for their species and be free of major deformities. Roots, whether in balls, grow bags or containers, should be firm but not hard, healthy in appearance and evenly spaced around stems. Root balls should be free of girdling roots or an overabundance of root material for the size of the container. Branches should be evenly spaced throughout the plant and not clustered in one location. All plant materials must be grown in a nursery under climate conditions similar to or hardier than the project site.

All plant materials shall meet or exceed the American Standards for Nursery Stock (ANSI Z60.1) most current version. The following findings shall be considered reason for rejecting plant material upon delivery:

- Plants exhibiting crown form or unbalanced branch structure that cannot be corrected using standard practices will be rejected.
- Plants that arrive on-site with broken leaders will be rejected.
- Plants that have root defects that cannot be corrected using standard practices will be rejected.

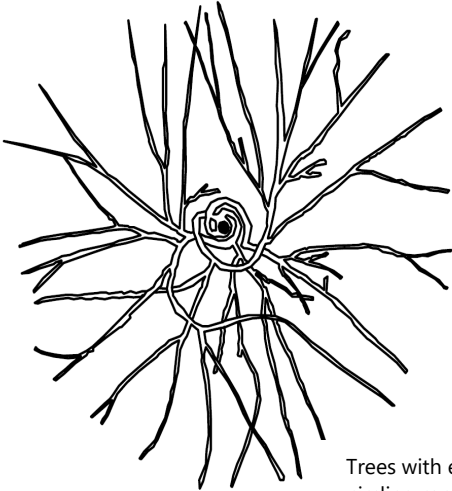

Trees with excess circling roots will be rejected.

**Soil Specifications**

Not all soil is suitable for growing plants. Existing soils within the right-of-way that have been impacted by construction activity are very poor quality. As a result, soil must be installed or amended as part of most new landscape installations. In order to comply with Washington House Bill 2713, locally produced compost products should be considered for use wherever possible and priority is given to products derived from municipal solid waste compost programs meeting quality standards adopted by rule by the Washington State Department of Ecology. The soil

specifications in this section apply to all streetscapes in City of Bellevue right-of-way, including growing media used in soil cells.

The following products are pre-approved “Type A” for streetscape construction projects:

Soil Use	Approved Product (Provider)
Soil additions to established landscapes	Winter Mix (Cedar Grove)
New Construction	Winter Mix (Cedar Grove)

All other products must meet the following specification for “Type A” topsoil:<sup>2</sup>

Sand	Greater than 0.05mm to less than 2mm – 60-70% by volume
Compost	30-40% by volume STA certified compost
Silt	Greater than 0.002mm to less than 0.05mm – maximum of 35%*
Clay	Less than 0.002mm – maximum of 15%*
Organic Content	Percent of dry weight – 10% Minimum
Acidity (pH)	6.0 to 7.5
Physical contaminants (plastic, concrete, ceramics, metal, etc.) shall be less than 0.5 percent by weight. Plastic film shall be less than 0.1 percent by weight.	
Soil shall be free of phytotoxic materials, viable seeds, roots or rhizomes of state listed noxious weeds	
Soluble salt contents shall be less than 3.0 mmhos/cm	

\*Clay and Silt combined – no greater than 40%

### Specifications for Soil in Soil Cells

All products shall meet specifications of the soil cell product manufacturer and/or project engineer. “Type A” topsoil may be approved for use in non-bioretenion soil cells at the discretion of the project engineer.

### Compost Specifications

Compost amendment improves the structure and function of soils by adding organic carbon and stimulating microbial activity. Compost may be added directly to streetscape planting areas to improve soil quality. Compost is also indirectly incorporated as a component of topsoil and mulch products. Whether applied directly or indirectly, all compost shall meet the following criteria:

<sup>2</sup> Additional requirements may apply. Products that are not on the Approved Product Provider list must be approved by the city per the “Submittals” section in this document.

- Compost shall be certified in compliance with the U.S. Composting Council STA program.
- Compost shall be manufactured through the controlled aerobic, biological decomposition of biodegradable materials.
- Compost shall have undergone mesophilic and thermophilic temperatures, which significantly reduces the viability of pathogens and weed seeds, and stabilizes the carbon such that it is beneficial to plant growth.
- Compost sanitization through the generation of thermophilic heat shall meet the standards of the Processes to Further Reduce Pathogens (PFRP), as defined by the Code of Federal Regulations Title 40, Part 503, Appendix B, Section B.
- Compost physical contaminants such as plastic, concrete, ceramics or metal, shall be less than 0.5 percent by weight. Plastic film contamination shall be less than 0.1 percent by weight.
- Compost shall be free of phytotoxic materials, viable seeds, roots or rhizomes of state listed noxious weeds.

**Mulch Specifications**

Mulching serves to conserve moisture, prevent soil erosion, suppress weed growth, moderate soil temperature and reduce compaction. See standard details for information on mulch placement and depth. More information on mulching is also located in Ch. 6 – Planting Bed Management. For right-of-way landscape installations, the following products are pre-approved:

Mulch Use	Approved Product (Provider)
Newly constructed beds, new plantings, beds needing nutrients, and after transplanting into established beds	Landscape Mulch (Cedar Grove)
Formal established landscapes	Landscape Mulch (Cedar Grove)
Semi-formal and informal landscapes	Wood Chip Mulch

All products must meet the following specifications:<sup>2</sup>

- Mulch for newly constructed sites shall be STA certified compost-based and consist of 35%-50% bark and 50%-65% compost.
- Mulch and compost component of mulch shall be free of phytotoxic materials, viable seeds, roots or rhizomes of state listed noxious weeds.
- Compost component of mulch shall meet the standards of the Processes to Further Reduce Pathogens (PFRP), as defined by the Code of Federal Regulations Title 40, Part 503, Appendix B, Section B.

- The bark component shall be derived from Douglas fir, pine or hemlock species and not contain resin, tannin or other compounds in quantities that would be detrimental to plant life.
- Mulch pH shall be between 5.5 and 7.5
- Mulch physical contaminants such as plastic, concrete, ceramics or metal shall be less than 0.5 percent by weight. Plastic film contamination shall be less than 0.1 percent by weight.
- Mulch shall be free of phytotoxic materials, viable seeds, roots or rhizomes of state listed noxious weeds
- Carbon to nitrogen ratio shall be 25:1 to 35:1, as determined using TMECC 04.01 "Total Carbon" and TMECC 04.02D "Total Kjeldhal Nitrogen".

**Structural Soil Specifications**

When soil volume for trees is limited by urban conditions, structural soils may be used to increase the volume of soil available for tree growth under hardscape or to connect nearby soil volumes under hardscape. This section consists of providing the design, installation and quality assurance of a planting mixture that is capable of both supporting overlaying flatwork while providing voids for root propagation, proper nutrient levels and sufficient planting medium to promote vegetative growth. Structural soil shall be comprised of a uniformly blended mixture of aggregate, growing medium, soil stabilizer and water.

Recommended Ratio of Materials for "Structural Soil"	
4 cy	Aggregate stone
1 cy	Growing medium
4 lbs., or as directed by manufacturer	Stabilizer
46 gal or to 20% by weight of growing medium	Water

Properties of Growing Medium for "Structural Soil"	
Gravel	Greater than 2mm to less than 75mm – 0% by volume
Sand	Greater than 0.05mm to less than 2mm – maximum of 60% by volume
Silt	Greater than 0.002mm to less than 0.05mm – maximum of 35%
Clay	Less than 0.002mm – maximum of 15%
Clay and Silt Combined	Maximum of 40%
Acidity (pH)	6.0 to 7.0

Salinity	Saturated extract conductivity shall not exceed 3.0 mmhos/cm at 25deg C
Organic Content	8-12% dry weight

Aggregate stone shall meet the following criteria:

- Stone shall be clean and of high angularity.
- Stone dimension aspect ratio should approach 1:1:1 with a maximum of 2:1:1.
- Single size stone shall be 60 to 75mm with clear sieve designation “Blasted Quarry Rock” or shall conform to 2” clear crushed aggregate. Cadman 2” clear crushed is pre-approved for use.
- Aggregate material shall be sound, hard, durable, free from salt, thin, elongated or laminated particles, organic material, clay lumps, foreign objects or other substances that would act in a deleterious manner for the intended use.

Soil stabilizer shall be a non-toxic anionic linear polymer per section 9-14.5(1) capable of binding the soil particles to the aggregate during mixing and placement of the structural soil mixture. Cross-linked polymers shall not be permitted. Application shall be per the manufacturer’s written instructions. “Stabilizer” from Stabilizer Solutions is pre-approved for use.

**Installation Standards**

**Soil Preparation Procedure**

Soil is to be installed per the specifications of the City of Bellevue Transportation Standard Detail SW-130-1.

- Soil shall be installed in lifts and compacted to 85% proctor. “Foot compaction” is often sufficient to meet this standard.
- Finished grade of soil at edges shall be flush with the top of curb and sidewalk.
- Soil shall be crowned at 1 inch per foot of bed width, to a maximum of 10 inches.

**Structural Soil Preparation Procedure**

Structural soil shall be mixed and installed in the following manner:

- Mixing of aggregate, growing medium, binder and water is to be performed on a clean, flat, hard and level surface using appropriate soil mixing equipment.
- Mix shall not be over-handled, as this can result in separation of the growing medium from the aggregate.



- Mixed structural soil shall be moist but not saturated with water when placed. The target moisture content is 20% by weight of the growing medium component and water in mix shall be adjusted as needed to meet this.
- Mixed structural soil shall be protected from absorbing excess water and from erosion at all times. Mixed structural soil shall not be stored or transported unprotected during rainfall events.
- Delivery to the job site shall occur immediately after mixing. Extended storage or stockpiling of structural soil is not permitted.
- Handling of structural soil should be kept to a minimum to reduce separation of components and variation in moisture content.
- Subgrade of areas designated as ‘Structural Soil’ are to be prepared to 95% Modified Proctor Density and shall be free of stones, debris, root branches, toxic materials, building materials and other deleterious materials.
- Structural soil shall be installed in lifts not to exceed 6 inches.
- Structural soil shall be compacted with static drum compactor equipment until appropriate compaction is achieved as evidenced by an unyielding subbase. Structural soil shall be protected from vibratory sources until final structure or pavement is in place.
- Structural soil shall be compacted to achieve 95% proctor.

After adequate compaction of the structural soil is confirmed, nonwoven geotextile shall be installed as a separation layer directly above the compacted structural mixture. All fabric seams should overlap and geotextile should wrap beyond edge of structural soil as shown in exhibit PK-IM-07E Planting - R.O.W. Tree with Structural Soil Section.

ASTM Designations for Geotextile	
Grab Tensile Strength ASTM-D-4632	0.400 kN
Tensile Elongation ASTM-D-4632	50%
Mullen Burst ASTM-D-3786	1270 kPa
Flow Rate ASTM-D-4491	6300L/min/m <sup>2</sup>

### Tree Planting Standard

A tree is a long-term asset. Care should be taken during planting to ensure success. Improperly planted trees may develop root issues that lead to poor stature or appearance, premature decline and death. Tree shall be planted as shown in appendix drawing PK-IM-07B “Planting – R.O.W. Tree”.

- The diameter of the planting hole shall be 3X the width of the root ball with sloped sides and rough edges unless otherwise specified in the

contract drawings. Depth shall be the depth of the root ball. The center of the hole shall be firmly tamped to prevent settling.

- Root ball shall be placed in the planting hole and positioned so that the strongest secondary branches point away from vehicle or pedestrian traffic. Root collar shall be located just above final grade, allowing for minimal settling. Depth of hole may be adjusted as necessary by removing or adding soil.
- Containers and twine shall be removed. If a wire basket or burlap is present, only the top half shall be removed. Leave the remaining wire and burlap in place.
- Project arborist shall locate root collar and confirm that roots do not circle the trunk, make contact with bark or make abrupt turns toward center of root ball. Some root problems may be corrected on-site under the supervision of an arborist. Per WSDOT Standard specifications 9-14.6(2), all plant material must meet the latest edition of the American National Standard for Nursery Stock (ANSI), ANSI Z60.1.

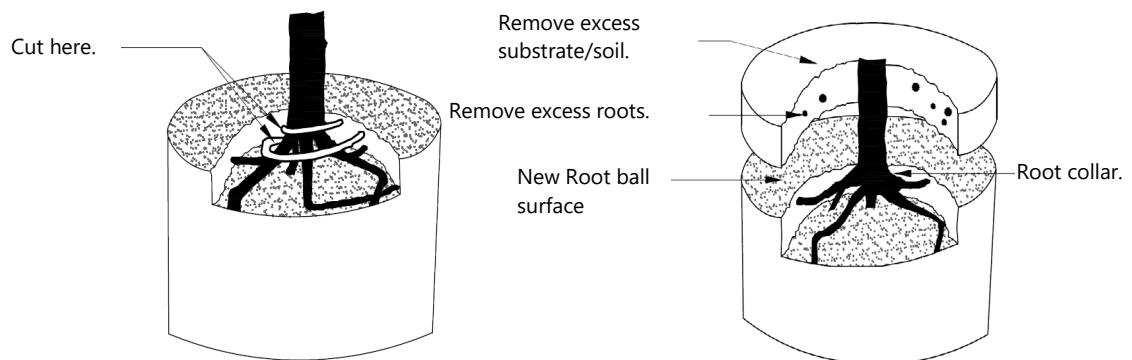

- Planting hole shall be backfilled in 6" lifts and gently tamped after each lift to eliminate voids.
- Planting pit shall be watered thoroughly after backfilling to settle the soil, eliminate air pockets and re-wet the root system.
- Mulch shall be applied over planting area to a depth of 2". Mulch shall taper back to grade at trunk to avoid contact with bark tissue.

- Wrapping materials, ribbons, twine and tag shall all be removed.
- Stakes shall be located outside of planting hole. Stakes and ties shall be removed at the end of the first year after planting.
- Installation of watering bags to water trees through the growing season until establishment is strongly encouraged.

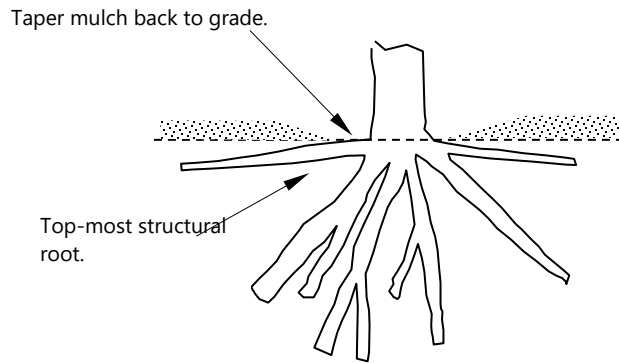

### Shrub Planting Standard

Like trees, care should be taken when planting shrubs, grasses and perennials to ensure that the city’s investment will return value to the community. Installation shall not be conducted under adverse weather conditions, as decided by city staff. The following conditions shall be met:

- Planting pit shall not be less than two times the width of the root ball diameter. Pits will be inspected by city staff at time of planting.
- Circling roots shall be untangled or pruned as needed.
- Planting pit shall be backfilled with native soil. Root crown shall be level with grade.
- All plants shall be watered in with hose or tank to ensure soil to root contact and to eliminate any voids created during planting.

### Mulching Standard

Mulch shall be applied to a depth of 2”. Mulch shall not contact tree trunks, nor cover root crowns of shrubs, grasses and perennials. Mulch shall be feathered so that finished grade of the bed is flush with top of curb or sidewalk at edges of planting area. See PK-IM-07B “Planting – R.O.W. Tree” for illustration.

## 8.3 Best Management Practices

The City of Bellevue maintains over 160 formal landscape sites within the right-of-way or easements, covering 201 acres city-wide. This land includes a wide variety of cover types and landscape features, including concrete walkways, gravel paths, rockeries, landscaped medians, sidewalk planters, turf, groundcover, shrubs and trees. Where the City of Bellevue is responsible for maintenance, that maintenance may be performed by in-house staff or by landscape contractors.

## Maintenance Standards

Landscape maintenance in the right-of-way shall generally follow the Best Management Practices described in Section 6.3, with supplemental instruction tailored to specific conditions encountered in the right-of-way. Landscape plants are pruned in order to meet the following:

- Pedestrian or bicycle travel is not impeded.
- Sight distance triangles are maintained to Transportation Design Manual Drawings RL-100-1, RL-110-1 and RL-120-1. Landscape plantings shall have a maximum height of 24" within the setbacks.
- Appropriate timing to encourage flowering or other aesthetic features.
- Appropriate timing to optimize effect and minimize future pruning needs.

All pruning is conducted according to current ANSI Z133 standards.

### Ornamental Shrub Pruning

Pruning shrubs supports their growth, while mitigating hazards and infrastructure conflicts. Proper selection and spacing minimize the need of pruning to control size. Shrubs in the right-of-way are typically not maintained in a hedge and natural form should be preserved as much as possible.

### Ornamental Grass Pruning

Much like ornamental shrubs, care of ornamental grasses varies between species and cultivars. Pruning shall be appropriate to encourage growth in the warm or cool season.

### Perennial Maintenance

Perennial species shall be appropriately winterized and prepared for spring growth.

### Watering

Ongoing application of supplemental water is crucial to maintain the city's investment in right-of-way landscaping, even with drought tolerant species. Arterial landscape spaces may experience harsh conditions such as poor soil, limited root space, reflected head, increased wind speed and air pollution. Efficient irrigation systems are installed in many landscapes to meet this need. At a minimum, right-of-way landscapes should be watered weekly through the first three years after installation. Where automatic irrigation is unavailable or insufficient for keeping plantings healthy, water is applied by hand using a tank, hose or other source. Watering bags should be installed on young trees shortly after planting and refilled a minimum of one time per week.

### LID Facility Maintenance

Natural Drainage Practices (NDPs) are Low Impact Development (LID) best management practices that are often used to manage stormwater in the right-of-

way. NDPs can improve water quality in lakes, rivers and streams by slowing or infiltrating runoff from streets and sidewalks. LID facilities such as bioswales or rain gardens may trap sediment, nutrients and other pollutants that are detrimental to aquatic life. Maintenance should be performed on these facilities in the streetscapes on a regular basis to ensure high performance. Maintenance plans shall follow standards for LID facilities as described in the City of Bellevue Utilities Department Surface Water Engineering Standards and the Storm and Surface Water Maintenance Standards.

The following items should be checked at each regular landscape maintenance frequency for streetscapes sites:

- Curb cuts and inlets are clear and water can flow in without obstruction
- Facility is free of noxious and invasive weeds
- Litter and debris is removed
- Pet waste is removed
- Outlets are clear and water can flow out without obstruction

### **Traffic Control**

Streetscape maintenance tasks that impact vehicle, bicycle or pedestrian traffic require specialized supervision and permitting. Traffic control plans are developed for this purpose and provided by the city where needed. A certified Traffic Control Supervisor may be required to supervise work on site according to the terms of the permit.

### **Holiday Lighting**

A Right-of-Way Use Permit is required to install holiday lighting on trees or other structures in the right-of-way. Applications can be submitted at [www.mybuildingpermit.com](http://www.mybuildingpermit.com). Additional information is available by emailing [RightOfWayUse@bellevuewa.gov](mailto:RightOfWayUse@bellevuewa.gov) or calling (425) 452-4189.

- Unless otherwise stated in the Right-of-Way Use Permit, lights must be removed from all trees between February 1<sup>st</sup> and October 31<sup>st</sup>.
- Lighting shall not be installed on any branch less than 1" diameter.
- Trees shall not be pruned or altered to attach lighting or decorations.
- Stapling, nailing or other bark puncturing means of attachment are prohibited.
- It is the responsibility of the adjacent property owner to maintain any electrical equipment within the right-of-way and ensure compliance with National Electric Code (NEC) and Bellevue City Code.

## Landscape and Maintenance Planning

In order to appropriately provision the maintenance of Bellevue's right-of-way landscapes, the Parks & Community Services Department creates a budget based on a systematic determination of cost.

### Workload Plans

Workload plans specify tasks to be performed, frequency of performance, and time standard to complete each task. Task frequency takes into account seasonal changes to maintenance needs. Workload plans reflect the most efficient standards to provide service and maintain the value of landscape assets. Reductions to frequencies or time standards may lead to degradation of the site, and the capital costs of repair are typically greater than the short-term savings in maintenance.

Tasks in the workload plan typically include:

- Turf mowing and edging
- Ornamental shrub and grass pruning
- Weeding
- Removing leaves and other debris from hard surfaces and landscape beds
- Operation and maintenance of above and below ground irrigation systems
- Litter pickup and garbage removal
- Cleaning garbage containers and replacing liners

Activity	Unit of Measure	Inventory Quantity	Time Standard	Time Std Per Visit	Frequency Per Month												Annual Freq	Annual Hours	
					J	F	M	A	M	J	J	A	S	O	N	D			
<b>Turf</b>																			
Mowing	SQ FT	10000	200	Min	50.0			4	5	4	4	5	4	5	4	1	36	30.00	
Trimming	LIN. FT	2500	20	Min	125.0			4	5	4	4	5	4	5	4	1	36	75.00	
Edging	LIN. FT	160	85	Min	1.9			2	3	2	2	3	2	2	2		18	0.56	
Fertilize Fine Mow	SQ FT	10000	190	Min	52.6			1				1				1	3	2.63	
Herbicide (Turf)	SQ FT	10000	160	Min	62.5					1							1	1.04	
Rough Mow	SQ FT	5000	300	Min	16.7			2	2	2	2	2	2	2	2		16	4.44	
Fertilize Rough Mow	SQ FT	5000	190	Min	26.3			1								1	2	0.88	
<b>Shrub Beds</b>																			
Bed Weeding & Hoeing	SQ FT	10000	175	Min	57.1	1	1	3	5	4	4	5	4	5	2	1	1	36	34.3
Bio Filter/Filterra beds	SQ FT	0	25	Min	0.0	1	1	3	5	4	4	5	4	5	2	1	1	36	0.0
Trim G. C.	LIN. FT	2500	50	Min	50.0				1		1			1		1	4	3.3	
Prune Shrubs	SQ FT	10000	100	Min	100.0			1								1	4	6.7	
Herbicide (Shrub Beds)	SQ FT	10000	160	Min	62.5					1							1	1.0	
<b>Street Trees</b>																			
Tree Grates	Each	0	10	Min	0				1								1	0.0	
Tree Pruning	Each	10	30	Min	300.0											1	1	5.0	
Tree Fert/Mulching	Each	10	5	Min	50.0			1							1		2	1.7	
<b>Hard Surface</b>																			
H. S. Sweep	SQ FT	5480	800	Min	6.9	2	2	4	5	4	4	5	4	5	4		39	4.5	
H. S. Weeds	SQ FT	5480	800	Min	6.9			1						1			2	0.23	
<b>Leaf/Litter/Debris</b>																			
Leaf Removal (Total Site Ft²)	SQ FT	30480	400	Min	76.2										1	4	4	9	11.4
Litter (Total Site Ft²)	SQ FT	30480	1200	Min	25.4	5	4	4	5	4	4	5	4	5	4		44	18.6	
Garbage Collection	Each	0	3	Min	0.0	5	4	4	5	4	4	5	4	5	4	4	4	52	0.0
Encroachment	LIN. FT	160	100	Min	1.6			1		1		1			1		4	0.1	
Windfall Debris	Included																		
Lane Closure/TCS services	Each	0	480	Min	0.0			1		1					1		4	0.0	
<b>Green Machine</b>																			
Green Machine	SQ FT	5480	100	Min	54.8	1		1		1		1		1		1	6	5.5	
Pervious Surface Moss Control	SQ FT	5480	50	Min	109.6										1		1	1.8	
<b>Irrigation Labor</b>																			
Start-up/Winterize	Per Zone	4	20	Min	80.0				1						1		2	2.7	
Irrigation Repair	Per Zone	4	30	Min	120.0			1	1	1	1	1	1	1			7	14.0	
<b>Irrigation Fees</b>																			
Water Billings (Conventional Zones)	Per Zone	3	40	GPM	120.0			100	140	180	200	170	140	100			1030	\$ 1,316.97	
Water Billings (Drip Zones)	Per Zone	1	10	GPM	10.0			300	420	540	600	510	420	300			3090	\$ 329.24	
Irrigation Meter Fees	Each	1.00	74.8	\$	\$ 74.83	1		1		1		1		1		1	6	\$ 448.98	
Controller Power Meter Base Rate	Each	1.00	10.7	\$	\$ 10.72	1		1		1		1		1		1	6	\$ 64.32	
Drainage Fees	Acre	0.00		\$	\$ -	1		1		1		1		1		1	6	\$ -	
Hand Watering (non irrigated areas)	SQ FT	0	0.05	\$	\$ 0.0				2	4	4	4	2				16	\$ -	
Hand Watering (Gator Bags)	Each	0	20	\$	\$ 0.0				2	4	4	4	2				16	\$ -	

Figure 1. Example Workload Plan

## Bid and Award Process

When right-of-way landscapes managed by the Parks & Community Services are maintained by private contractors, they are under the direction of a Contract Administrator. Contracts are awarded through a competitive process that takes into account a bidder's ability to successfully complete required tasks, protect the safety of pedestrians and motorists, and the provide cost-effective service.

## Inspections

The work of contracted landscape maintenance providers is regularly inspected by city staff to ensure satisfactory performance. Inspections are also used to identify safety hazards, graffiti or other vandalism, and damage to plants, trees, or irrigation systems.

## Young Tree Pruning

Training young trees in the years after planting is essential to encourage good form and correct structural flaws that can lead to serious and costly problems later on.

Pruning young trees requires a high level of skill and is performed by trained staff. All new trees planted in Bellevue's managed streetscapes are proactively pruned during the first 5 years after planting.

### **Standards of Pruning**

All trees are to be pruned to ANSI A300 standards.

- During the first two years, prune with clean cuts to remove damaged or crossing branches and train to a single leader.
- Structural branches should be selected to maintain a balanced radial distribution of weight on the stem. Closely spaced branches should be thinned out.
- Gradually remove lower limbs annually to provide clearance to roads and sidewalks, and train branches away from signals, signs and buildings.

### **Tracking and Assignments**

Parks maintains a database of tree location and attributes. Shortly after planting, data is collected and the tree is added to the database and assigned to the young tree program. Trees are assessed and pruned annually while assigned to the young tree program.

### **Threshold to Mature Tree Pruning**

Once appropriate clearance above streets and sidewalks is established, large-statured trees are assigned to a long-term pruning schedule. Small-statured trees may continue to be pruned by in-house city staff.

## **Mature Tree Pruning**

### **Street Tree Cycle Pruning Program**

The purpose of the Street Tree Cycle Pruning Program is to support the health of mature trees, encourage appropriate form and structure, minimize potential safety hazards and to maintain pedestrian and vehicle clearance on adjacent streets and right-of-ways.

### **Standards of Pruning**

All trees are to be pruned to ANSI A300 standards. Cycle pruning addresses the following issues:

- Improvements to health, structure and form of trees
  - Remove multiple leaders, crossing branches and suckers
  - Remove dead or broken branches and diseased tissue
  - Shorten limbs that are imbalanced or have bark inclusions.
- Appropriate clearances over sidewalks and roadways
  - Provide 7' minimum clearance over sidewalks at maturity
  - Provide 14' minimum clearance over streets at maturity



- Remove branches obstructing pedestrian or bicycle travel
  - Remove obstructions to sight distance triangles
- Mitigation of conflicts with objects in the right-of-way
  - Branches and foliage shall not obstruct traffic signs
  - Branches and foliage should not obstruct street lights
  - Branches should be clear of power lines
  - Branches should be clear of buildings and awnings

### **Bid and Award Process**

Established street trees are pruned on a regular cycle by qualified contractors under the direct supervision of an International Society of Arboriculture (ISA) Certified Arborist, Certified Forester or licensed Landscape Architect. The actual cycle varies depending on funding - typically every 6 to 10 years as needed.

### **Tracking and Assignments**

The Parks Department maintains a database of tree location and attributes. Pruning needs are assessed annually and maintenance activity is tracked. Trees are assigned an attribute for health and trees that are found to be in need of monitoring for health or structural deficiency are inspected annually.

### **Tree Grate Program**

Many street trees are sited in tree wells that have decorative grates installed over the top to increase the walkable surface of a sidewalk. As the trees grow, these grates may shift and cause harm to the tree trunk or create potential tripping hazards for pedestrians. Tree wells must be regularly inspected and maintained.

### **Standards of Tree Well Maintenance**

The following maintenance actions are undertaken to maintain pedestrian safety and tree health:

- Grate aperture is increased to accommodate tree growth.
- Unstable grates are adjusted or removed.
- Weeds and debris are removed from tree wells.
- Suckers, girdling and adventitious roots are removed from trees.

### **Inspections, Tracking and Assignments**

- Respond to reports and complaints of broken or unstable grates.
- Conduct annual inspections and maintenance.
- Root strapping, girdling roots, adventitious roots, suckers and irrigation damage are identified and addressed.
- Evaluate trees for additional needs, such as pruning for pedestrian clearance, vehicle clearance, sight distance or road signage.

## Streetscape Renovation Program

### Planting Bed Renovation

Even with regular maintenance, streetscape planting beds have a life cycle of 15-25 years. Bed renovation is prioritized based on age, condition, visibility, available funding and the opportunity to pursue revitalization projects in partnership with other departments. Renovation may include amending and improving the soil, revitalizing broken irrigation systems and installing new plant material.

### Tree Removal and Replacement

The Street Tree Replacement Program contributes to the maintenance of healthy tree canopy throughout the city. The Street Trees and Arterial Landscapes group identifies and removes hazards from dead, damaged and dying trees in order to support safe and inviting pedestrian environments. Staff or contracted tree service providers perform the following tasks for right-of-way trees that Parks & Community Services manages:

- Maintain an inventory of right-of-way trees managed by the Parks & Community Services, including dead, dying and missing trees.
- Inspect all trees in the streetscapes inventory at least once per year either during site inspections or during tree status updates.
- Remove and replace dead or hazardous trees as needed.
- Replace trees in vacant planting locations.
- Collect compensation for trees killed or damaged by vandalism or vehicle impacts per BCC 1.18.045.

### Thresholds for Tree Removal

Like any living plant, trees have a life cycle and inevitably decline as they age. All trees are susceptible to disease, physical damage, insect infestation and drought. Targeted tree removal restricts the spread of disease and reduces the possibility of injury or property damage. When a tree that the Parks & Community Services Department manages is damaged or visibly declining, city staff or a professional arborist will evaluate the tree to determine if removal is warranted or necessary.

Occasionally, healthy trees may be considered for removal. A healthy tree may be removed for the following reasons:

- Approved construction will compromise the health of the tree.
- Tree is creating an unsafe obstruction within sight distance triangles.
- Tree cannot be kept clear of overhead utilities without excessive topping.
- Tree presents a risk to safety or to public or private property.

The City of Bellevue has been losing tree canopy for the last few decades. In the 2015 Comprehensive Plan, the City of Bellevue adopted a goal to achieve 40% tree

canopy coverage city-wide. One part of the toolkit for reversing the downward trend and reaching the goal is a tree replacement fund, provisioned through BCC 1.18.045 and BCC 14.60.120. The city shall be reimbursed for the value of illegally damaged or removed trees, and may be reimbursed for the value of trees or landscaping removed in development that cannot otherwise be replaced or restored. The penalty or reimbursement is typically put into a fund dedicated to planting trees in appropriate locations. Tree value is determined using the industry standard Guide for Establishing Value of Trees and Other Plants, published by the International Society of Arboriculture, which takes into account species, size, health, site conditions, existing conflicts and replacement cost.

### 8.4 Training

- All staff involved in construction activities should be trained on best management practices for construction sites.
- Site managers and inspectors shall receive education and training pertinent to the maintenance of formal landscapes and working safely in the right-of-way.
- Parks staff that prune trees will have ISA Arborist or Forester certification. Contracted workers shall have ISA Arborist certification or be supervised by an ISA Arborist or Forester.
- Contracted workers or volunteers will be instructed in proper shrub pruning and planting techniques by parks staff.
- Contract Administrators and Lead Workers will receive ATSSA traffic control training. All contracted work crews shall have at least one ATSSA Certified Flagger.
- Parks staff or contracted workers on sites where a permitted alteration of traffic flow such as a lane closure or shift is required must be supervised at all times by an ATSSA Certified Traffic Control Supervisor for setup, management and removal of traffic control devices.

# CHAPTER 9 – Trees and Natural Areas

---



## 9.1 Purpose

Trees and natural areas provide a multitude of benefits that enhance the quality of our lives. The maintenance and management of these valuable resources is essential for the long-term health and welfare of Bellevue and its residents. The health of the urban forest is a major indicator of the health of our ecosystem. This chapter identifies and defines the best management practices required to ensure a healthy urban forest.

## 9.2 Background

The Bellevue Parks Department manages approximately 2,000 acres of undeveloped natural areas consisting of forests, steep slopes, wetlands, riparian corridors, shorelines and meadows. The management and preservation of the city's natural areas is a long-term investment into the urban environment that must be managed with the same skill and diligence as any other city asset.

Public trees and forests in Bellevue can be classified into three categories:

1. Street Trees: Are part of improvements made within the City of Bellevue right-of-way through either capital improvement program projects or private

development. A detailed treatment of the BMPs and City Codes associated with this resource is provided in Chapter 8 of this manual.

2. Formal Park Areas: These trees require frequent maintenance and have a high likelihood of tree/people interaction. These trees also have a potential for mechanical injury and demand a high level of care and consideration during design and construction activities.

3. Natural Areas and Peripheries of Formal Park Areas: These trees require the least amount of maintenance because of their often remote and sheltered locations. The trees in these areas are managed not as individual trees, but rather as stands of trees linked to the associated plants and sites on which they reside. These trees can come into conflict with people when they occur along property lines, adjacent to man-made structures or near gathering places.

## Design

### Selection

Selecting trees that adapt well to their site and fulfill their landscape function is extremely important to the success and maintenance of a planting. The quality of young plants is also crucial. A plant species should be selected based on its functional uses, its adaptation to the site and the amount of care it will require.

### Landscape Functions

There are four main functions to consider when selecting trees to include in the landscape design:

1. Architectural Features: Privacy, view enhancement and space articulation.
2. Engineering: Reduce glare, direct traffic, filter air, reduce soil erosion and attenuate noise.
3. Climatic Influences: Transpirational cooling; interception of solar radiation, reflection and re-radiation; and modification of rain, fog and snow deposition.
4. Aesthetic Uses: Form, color and texture.

### Site Adaptation

It is important to plant the right tree in the right place. The intended landscape use and nature of a site should be considered when selecting for growth habit and ultimate size. Mature size is an important consideration. The tree should not outgrow its allotted space given such constraints as vistas and powerlines. Table 9.1 may be used as a guide in selecting the right tree.

**Table 9.1** Tree Selection Factors

<b>Feature</b>	<b>Benefit</b>
<b>Rate of Growth</b>	Fast-growing trees tolerate difficult sites, are usually weak-wooded and subject to limb breakage, and are generally shorter lived. The opposite is generally true for slow-growing trees.
<b>Wood Strength</b>	When a tree decays or weakens, it can become a hazard to the surrounding area. Strength is based on the trees' ability to withstand wind loads, snow bearing loads, water saturation or drought, ability to compartmentalize decay and its adaptability to its surroundings.
<b>Rooting</b>	Roots keep the tree anchored in the ground. Through them pass nutrients and water that nourish and support the tree. Stressors such as: drought, flooding, disturbance, disease or damage can greatly affect tree roots and the health of the tree.
<b>Plant Features</b>	<ul style="list-style-type: none"> <li>• Leaves: Color, size, persistence</li> <li>• Thorns and prickly foliage: Enhanced security vs. maintenance problems</li> <li>• Flowers and fruit: Aesthetic consideration, fragrance and wildlife habitat. Potentially increased maintenance.</li> </ul>
<b>Climate Adaptation</b>	<ul style="list-style-type: none"> <li>• Plant hardiness and local minimum temperatures</li> <li>• Moisture – natural or irrigated</li> <li>• Light – reflect or allow for winter heating</li> <li>• Wind – deflect or channel wind patterns</li> </ul>
<b>Soils</b>	Poor soils can cause tree failure. Amendment not desirable or feasible. Match tree to soil condition.
<b>Air pollution</b>	Choose trees with appropriate tolerance level.
<b>Pest Resistance</b>	Trees resistant to pests and disease will reduce maintenance.
<b>Native Plants</b>	Native or indigenous trees may not perform as well as exotic or non-native species. Most urban landscape sites are no longer "native." Soils, microclimates and water regimes have changed.
<b>Selecting Quality Stock</b>	Selection of quality planting stock is as important to success as selection of proper species, planting and maintenance. Root and shoot quality can determine not only performance but also survival.
<b>Root Defects</b>	Kinked and girdling (circling) roots can eventually "choke" a tree.
<b>Top &amp; Trunk Characteristics</b>	<ul style="list-style-type: none"> <li>• Height-to-Caliper ratio (see ANSI Z60.1 specs.)</li> <li>• Crown configuration</li> <li>• Branching pattern</li> </ul>

## 9.3 Best Management Practices

The management and maintenance of trees by the City of Bellevue Parks & Community Services Department consists of a number of practices. The practices are covered in the following section and include: planting, pruning, removal, inventory and routine inspections, irrigation, fertilization and pest management. Activities associated with the protection and management of trees and vegetation before and during construction are covered in Chapter 1 of this manual.

### Formal Park Tree Planting

- All plant material shall be nursery grown under climate conditions similar to or hardier than at the site and meet or exceed The American Standards for Nursery Stock (ANSI Z60.1).
- Ideal planting hole should be 2 to 5 times the diameter of the root spread or root ball.
- Minimum planting hole shall be 12 inches wider in diameter than root spread or root ball.
- The hole shall be no deeper than the ball and the ball shall sit firmly on undisturbed subsoil.
- Native soil shall be used to backfill the planting hole except in situations where the existing soil is contaminated or filled with rubble or pure clay.
- Balled-and-burlapped (B&B) trees shall be placed in the hole and plumbed vertically. All rope shall be removed from around the trunk of the tree and the top 1/2 of the burlap shall be folded back down into the hole. Whenever possible, remove the top 1/2 of burlap by cutting it away with a sharp knife. Trees in wire baskets shall have the wire completely removed, using bolt cutters, before backfilling.
- B&B packaging material shall not be removed until the tree is placed in the hole and securely plumbed into its final position.
- Soil should be backfilled in lifts of 4 to 6 inches at a time with compaction of each layer. Do not compact saturated soil. Water thoroughly after backfilling to settle the soil, eliminate air pockets and re-wet the root system.
- Trees planted in sandy or loamy soils should have a 3-inch-high berm erected just past the perimeter of the planting hole to funnel water to the root ball and wet the hole or sidewall interface. Berms should not be constructed in clay soils or on heavily compacted sites.
- All trees shall be mulched with 3 to 4 inches of organic mulch or arborist chips immediately after backfilling. Whenever possible, maintain 3 to 4 inches of mulch annually.

- Mulch shall extend past the diameter of the tree planting pit at least 6 inches.
- Mulch shall be kept away from the tree trunk. Mulch shall taper from the 3-4 inch depth back to grade right at the trunk to avoid decay of bark tissues.
- Newly planted trees shall be watered weekly through the first 3-5 growing seasons.
- Trees shall receive approximately 1 inch of water per week including rainfall.
- Weeds should be suppressed within the mulch ring to eliminate competition and for aesthetics in formal parks and along streets.
- Weeds and/or turf shall not be allowed to grow up to the tree trunk at any time. This increases the likelihood of mechanical trunk injury.
- Ideal months for planting are October through April, as long as the ground is unfrozen.
- Stake only in situations where normal planting procedures do not provide a stable plant. Otherwise, staking is generally not required.
- Stakes and ties shall be removed at the end of the first year.
- Root flare shall be at or slightly above grade to allow for slight settling.
- Tree trunks shall not be wrapped.
- Tree trunk wrapping materials, tags, and all ties shall be removed at time of planting.

### **Natural Area Planting**

- All plant material shall be nursery grown under climate conditions similar to or hardier than at the site and meet or exceed The American Standards for Nursery Stock (ANSI Z60.1).
- A 5-by-5-foot area should be free of competing vegetation for 3-5 years.
- Staking of newly planted trees is generally not necessary. If staking is necessary because of size or conditions, stakes shall be removed at the end of the first year.
- New trees shall be watered bi-weekly, or as required, during summer drought stress periods for the first 3-5 establishment seasons.

### **Container/Bare Root Planting**

- All plant material shall be nursery grown under climate conditions similar to or hardier than the planting site and meet or exceed The American Standards for Nursery Stock (ANSI Z60.1). Container plants shall have the container removed prior to placement in the planting pit.



- Loosen pot-bound roots with hands or tools prior to final placement in planting pit. Kinked and girdled roots shall be pruned.
- Bare root plants shall be protected from root drying prior to and immediately after planting.
- Cleanly prune exceptionally long roots to create a uniform root mass.
- Plant bare root stock at the same grade as grown in the nursery.

## Tree Removal

Due to the economic, environmental and social benefits of trees, their removal must be well thought out and documented. At times, trees may be removed for new park construction, access or other issues not related to tree viability.

Like any living plant, trees have a life cycle and eventually decline as they age. All trees are subject to diseases, physical damage, insect infestation and drought conditions. Any one of these factors, alone or in combination, can contribute to the decline of a healthy tree. Quick removal restricts the spread of disease and reduces the possibility of human injury or property damage. When a tree is either dead or visibly declining, city staff or a professional arborist will evaluate the tree to determine if removal is warranted or necessary. Not all declining or dead trees will be removed, particularly if the tree doesn't present a danger to the public or to property. Where appropriate, trees will be left as wildlife snags in natural areas and new trees should be planted as a replacement.

Occasionally, healthy trees, without any known or apparent defects, will be removed from park property. If a tree is blocking roadway site lines, disrupting underground utilities, interfering with overhead utilities, damaging hard surfaces or presenting a risk to the public, it may be considered for removal. If tree pruning can address the site line issues, pruning will be considered as a first option before removal. Some urban trees are problematic based on species. Cottonwood (*Populus trichocarpa*), red alder (*Alnus rubra*) and big leaf maple (*Acer macrophyllum*) are all prone to limb failure, short life span and disease. These tree species may be removed based on consideration of future growth characteristics and issues associated with their location.

## Hazard Trees

- Tree risk assessments shall be performed by qualified personnel to the standards established by the International Society of Arboriculture.
- High risk trees that cannot be made safe or functional by appropriate mitigation shall be candidates for removal.
- Tree risk ratings shall be the first determining factor in removal decisions.

### **Tree Removal Permitting**

In general, tree removal in the City of Bellevue is regulated by BCC 23.76. A clearing and grading permit is required to remove one or more trees if the total canopy area covers 1,000 square feet or greater on the ground. A tree with a diameter of 24 inches or greater is considered a landmark tree and requires a permit for removal. In sensitive areas, such as steep slopes, riparian corridors or along shorelines, all tree removals must be permitted through the Developmental Services Department. In addition, all tree removals occurring in the public right-of-way must be accompanied by a right-of-way use permit, regardless of the amount of canopy area.

### **Thinning**

As a normal practice, new trees are planted in forested areas relatively close to each other. In Western Washington, it is common for the forest in early successional stages to be overcrowded with dense stands of young trees competing for air, light and nutrients. As the surviving trees mature, selective thinning is required to improve air circulation, encourage understory light and to provide adequate space for the future growth of the remaining trees. An effort to diversify tree species is a priority and diversity is a consideration for selecting the trees that will be removed. Trees should be removed early enough to promote healthy conditions for the remaining trees.

### **Stump Removal**

In developed park areas, stumps should be removed to make the area more aesthetically acceptable and to eliminate hazards. Stump removal involves the grinding out of all stumps to a depth of 12 to 24 inches below the surface, leveling the entire area and top dressing with soil. In natural areas, stumps are generally left in place to provide wildlife habitat except in situations where it is necessary to control the spread of disease, such as laminated root rot.

### **Adjacent Property Tree Issues**

When city staff becomes aware of a dangerous tree on private property, which could impact park infrastructure or public safety, a letter will be sent to the property owner notifying them of the city's concern and putting them on notice for future liability. When a property owner contacts the city regarding a potentially dangerous park tree, staff will investigate the request and follow up with a written response or will coordinate a site meeting with the property owner to discuss their concerns. Requests for removal or pruning based on increasing light, safety and building preservation will be addressed with the property owner on site to develop an action plan. The city will try to accommodate the property owner's requests whenever it's practical or reasonable. The city will not prune or remove park trees due to: trees having pollen, cones, seedpods and needles; trees blocking views from adjacent property; or trees creating conditions that might be considered a nuisance. It has

been established in Washington State through case law that a landowner has the legal right and obligation to engage in self-help by pruning encroaching branches and/or roots of a neighbor's tree that encroaches onto his or her property back to the legal boundary line as long as such action does not cause irreparable harm resulting in a tree's death. As such, the city is not legally required or obligated to prune tree branches or roots that encroach onto adjacent properties from city managed park and open space sites. However, any such pruning request that is made by an adjacent property owner will be evaluated on a case-by-case basis, and in some instances, the city may elect to provide such pruning services if it is in the best interest of a tree's long-term health (e.g. pruning back to a branch collar).

There are many instances, especially within natural areas, where a tree may be growing directly on the legal property boundary between city property and an adjacent private property creating a situation where there is shared ownership of the tree. Under these circumstances, the city will generally take on the full maintenance responsibility of the tree since the city has more technical expertise and experience regarding tree care. If a conflict exists where such a tree is damaging infrastructure (e.g. fencing, building foundation) on the adjacent property, and the property owner submits a request to have the tree pruned or removed, the following actions shall be taken:

- The city will determine the location of the legal property boundary to verify tree ownership. This may require having a professional survey completed.
- Once it is verified that the tree is fully or partially located on city property, the city may initiate action to have the health of the tree assessed either by a city arborist or by a 3<sup>rd</sup> party consulting arborist.
- If the tree is determined to be in a state of decline and/or has a short life expectancy, the city may initiate action to have the tree removed, thus alleviating the conflict.
- If the tree is determined to be healthy, the city will meet with the adjacent property owner to discuss noninvasive options that would alleviate the conflict without harming the tree. An example would be relocating a section of private fence to allow more room for the tree to grow, just as long as the fence remains on private property.
- If the tree is healthy, and the infrastructure cannot be relocated, the city may consider initiating action to prune the tree if such action would alleviate the conflict.
- If the tree is healthy, and pruning initiated by the city would not alleviate the conflict, then the city may consider allowing the adjacent property owner to implement the necessary mitigation (e.g. root pruning) to

alleviate the conflict if the work can be done in such a manner as to cause no irreparable harm to the health of the tree. The city will require that any such work be performed by an ISA Certified Arborist. If such action did cause irreparable harm and loss of the tree, the city may seek compensation for the lost value.

- If the tree is healthy, and there are no options available to mitigate the conflict without removing the tree, and the adjacent property owner is insistent on having the tree removed, then the city may consider the following actions:
  - The city will determine the estimated cost of removing the tree.
  - The city will determine the appraised value of the tree using the latest edition of the *Guide for Plant Appraisal* (Council of Tree & Landscape Appraisers).
  - The city may consider removing the tree if the property owner agrees to pay for all removal expenses and compensate the city for the full appraised value of the tree.
  - It is advisable that parks staff consult with the City Attorney's Office to obtain legal advice under these circumstances.
- It should be emphasized that all the actions described above will only be considered in situations where trees conflict with infrastructure. In no way will these actions be considered for situations where an adjacent property owner submits a request to prune or remove a tree specifically for the purpose of creating, maintaining or enhancing private territorial views.

### **Tree Failure & Liability**

If a tree located on private property falls onto park property, the city will clear debris and remove limbs up to the park property line. If a tree located on parks property falls onto private property, the city will only clear debris and remove limbs up to the park property line. Under no circumstances shall city staff enter privately owned property to remove, clear or prune trees, or parts of trees regardless of origin. Any adjacent property that is damaged during a weather-related event by trees that were originally located on parks property shall be referred to the city's Risk Management Office.

### **Transplanting**

If trees are smaller than 10 to 12 inches in diameter, it is possible to transplant them with an appropriately sized tree spade. The cost of transplanting should be weighed against the cost of replacing the tree with a new smaller caliper tree. Establishment of large trees is often less successful than planting a new one of smaller size. The value of the tree to be transplanted should also be considered when deciding on

removal or replacement rather than transplanting. Different methods of appraising value are reviewed in the most recent edition of the *Guide for Plant Appraisal* produced by the Council of Tree and Landscape Appraisers.

### **Irrigation**

In general, established trees do not require supplemental irrigation except during periods of extreme drought.

- Valuable specimen trees may be irrigated during periods of extreme drought.
- Turf irrigation around established trees shall be modified to accommodate the water requirements of the trees.
- Excessive water spray on tree trunks can lead to decay in some species. See Chapter 4, Irrigation and Water Management, for additional information on irrigation best management practices.

### **Pruning**

Pruning is sometimes necessary for young trees. Branches that grow into a pedestrian pathway can be dangerous. Generally, branches that grow below 7 feet above a pathway or below 14 feet above a parking lot or driveway entrance shall be clearance pruned. Dead branches should be pruned to restore vigor to a tree. All pruning shall be performed to current ANSI A300 standards.

Learning the proper method is important as you can seriously wound or even kill a tree if pruning is not done correctly. The best time to prune live branches is late in the dormant season or very early in spring before leaves form. Dead and dying branches can be pruned anytime. Use clean sharp tools and make clean cuts. When pruning multiple trees, tools should be sanitized in between trees to prevent the spread of disease. Do not:

- Leave living or dead stubs
- Injure or remove the branch collar
- Paint cuts

Topping and/or heading cuts shall be prohibited.

## **Forest and Natural Area Management**

### **Natural Resource Enhancement Plans**

A Natural Resource Enhancement Plan is based on an analysis of the ecosystem and the interrelationships of the different components of natural systems, as well as the human impact on their functions. Natural Resource Enhancement Plans are created based on information gathered about the site both in the field and through available

background data. This information is then utilized to reflect the goals of the community and the City of Bellevue. Identified within an Enhancement Plan are the overall intentions for the property.

A Natural Resource Enhancement Plan for a specific site contains the following elements, with maps to illustrate where possible:

- Property description and site history
- Sensitive area classifications
- Soils and topography
- Existing vegetation
- Liability trees and situations
- Wildlife
- Recreation
- Management prescriptions

### **Boundary Surveys and Staking**

- Upon purchase/transfer of a new property to the City of Bellevue or when a property has not previously been surveyed, a boundary line survey shall be conducted so both the city and the adjacent property owners are aware of the location of the property lines.
- Boundary surveys shall be conducted by a professional survey firm or City of Bellevue survey staff.
- Following a boundary survey, carsonite or pog posts with city information shall be installed at all surveyed property corners to aid in the future identification of shared property lines and management of city assets. When the stakes are installed, care should be taken to ensure that the stakes are placed accurately on legally surveyed monuments and aligned so that the decal, with city information, faces toward adjacent parcels. Ideally, it is best to have the professional survey company install the carsonite posts while they are actively performing the survey.

### **Site Inventory**

The first task in managing our resources following acquisition and liability mitigation is a thorough inventory of the resource itself. The resources needed to accomplish the site inventory include:

- Deeds and purchase documents
- City and county plat maps
- Recorded surveys and easements
- Topographic maps
- Aerial photos

Start with an inventory of the ownership. Locate the original closing papers, recorded easements, deeds of trust or any conveyance documents that describe the property. The goal is to discover the boundaries, legal histories and easement restrictions on the land to be managed. If files on the site are incomplete, the County Property or Records Department may prove helpful. Be sure to provide any parcel numbers, legal descriptions, plat names and even street addresses to assist in the research.

The next step in a site inventory is to collect site-specific information. Site-specific inventory information will help direct the implementation of operational activities necessary in maximizing open space objectives. The site-specific inventory information shall include:

- Site history
- Boundary delineation
- Site liabilities and encroachments
- Vegetation habitat type and successional stage
- Soils, aspect and topography
- Fish and wildlife habitat
- Recreation opportunities
- Sensitive areas

All of the site inventory information should be documented and stored for future reference and the development of Natural Resource Enhancement plans.

### **Routine Site Inspections**

All forest and natural areas shall be inspected on an annual basis. There are, however, two levels of inspection detail that the inspector may use, first and second-priority inspections.

The most detailed and comprehensive inspection is referred to as a first-priority inspection. First-priority inspections are conducted on sites scheduled to receive enhancements for the year or sites that are politically or environmentally sensitive.

As the names imply, first-priority inspections occur ahead of second-priority inspections. This is because first-priority inspections are meant to identify forest management areas of concerns and enhancement tasks, verify the existence of all boundary markers, discover any trespass issues (encroachments, dumping, or illegal tree cutting) and monitor the progress of past enhancement projects. A second-priority inspection, although not as time-consuming, is still comprehensive and well documented. Second-priority inspections cover the balance of open space properties and consist of a general site reconnaissance. Second-priority inspections are focused on the discovery of potential liability situations.

While conducting a site inspection, it is important to respect the adjacent property owners' rights and concerns. The inspector is a representative of the City of Bellevue and should be polite, courteous and professional at all times. Inspection staff shall wear high visibility vests and clothing with clear markings that identify them as City of Bellevue employees. If questioned by adjacent property owners, inspection staff shall present credentials (city ID badge) to verify identification as a city employee.

### **Inspection Procedure**

Pre-inspection planning needs to be done to ensure a safe, productive and successful inspection. Spending a few minutes planning and discussing the inspection will help eliminate wasting time over something forgotten.

- Before leaving the office, get a picture of the site characteristics and location.
- Determine whether you need to be carrying out a first or second-priority inspection and get answers to any questions you might have.
- Let someone in the office know your work plans and location, preferably your supervisor.

Property inspections can be a slow and demanding process. Thick vegetation, steep slopes, unmarked property lines and bad weather all conspire to make the inspection process challenging.

- Use aerial photos to identify your location by looking for identifiable structures or rooflines.
- Inspect the property line and document all property markers and liability trees.
- Look for and document with pictures any encroachments, dumping, vegetation removal and unauthorized tree cutting. Identify the location on the map. The use of a GIS geodatabase through a mobile collection application will help streamline this process.
- If unlawful camps or other illegal activities are discovered, notify the proper authorities for removal.

If there are trails on the property, walk the trails and record their general level of upkeep. This brief walkthrough can help the trails crew address maintenance issues.

Clean and sanitize any tools that were used during the inspection process. Report any significant findings to your supervisor that require follow-up with an adjacent property owner.



### **Liability Tree Monitoring**

Once a tree is designated as a liability tree it shall become the burden of the staff at hand. Although it may be easier and less complicated to simply remove all liabilities, the conservation of trees is something that must be considered until the tree can either be replaced or the tree becomes too great of a liability and must be removed.

### **Trespass Enforcement**

Trespass enforcement consists of remedying any of the following actions on park property: clearing of vegetation, including the topping of trees; dumping of debris; and encroachment by construction or developed structures. In 1993, the Parks & Community Services Department developed a Parks Department Encroachment Policy in response to numerous encroachment issues. In the years that followed, the Parks Department clearly identified many of its property boundaries by installing boundary markers. Inasmuch as the installation of these markers greatly reduces the number of trespass situations that arise, they still occur on a regular basis.

The Parks Department Encroachment Policy, although developed specifically for encroachment issues, can be applied to all trespass situations. The three steps the policy outlines for the enforcement of encroachment issues are as follows:

1. Voluntary Removal of Encroachment. This would primarily be facilitated by Bellevue Parks staff working directly with the property owner to find a mutually agreeable restoration plan and the implementation of such a plan. The interaction with the property owner is usually a mixture of both on-site visits and formal letters.
2. Boundary Line Adjustment. This option will only be considered a possibility in a situation where the property owner is able to “exchange” land of equal size, value and condition for the land that is encroached. All costs associated with a Boundary Line Adjustment would be borne by the property owner. For clearing or dumping situations, this option would not be considered. Bellevue Council has final approval of all Boundary Line Adjustment decisions. In general, boundary line adjustments are only pursued if there is a clear public benefit to be gained.
3. Legal Action. This option is necessary in the rare case where the property owner refuses to accept the trespass as true or refuses to remedy the situation voluntarily. The city manager’s approval is required for the use of legal action for enforcement of a trespass.

### **Natural Resource Enhancement Implementation**

This task should be utilized for all activities related to the implementation of a Natural Resource Enhancement Plan. This includes but is not limited to the following:

- Debris removal & cleanup

- Liability tree removal
- Preparation and planting of enhancement sites with native plant species
- Silvicultural prescriptions
- Trail construction or upgrades

### **Silvicultural Prescriptions**

Silvicultural prescriptions are also known as forest management practices. These shall be implemented in accordance with the City of Bellevue's land use policies for open space. Sound forest management practices support park functions by maintaining and enhancing a biologically diverse community consisting of a mixture of age classes and plant species, as well as wildlife habitat and recreational opportunities.

The management goals for most parks are as follows:

- Public safety
- Improve forest conditions
- Protect and enhance wildlife
- Provide recreation
- Buffer land uses
- Protect water quality

### **Sensitive/Critical Area Management**

Sensitive or critical areas are defined as those areas that can be adversely affected by any non-natural process, causing degradation to that area, or its biological processes. The City of Bellevue Land Use Code and The Critical Areas Handbook define critical areas as:

- Areas of special flood hazard
- Riparian corridors, excluding Type C and D
- Wetlands, excluding Type C
- Areas of colluvial or landslide deposits on slopes of 15% or more
- Slopes of 40% or more
- Areas potentially affected by abandoned coal mines
- Shorelines and aquatic habitats

The Bellevue Parks & Community Services Department recognizes the special importance of these areas, as well as others not defined by the Land Use Code, that fall under its stewardship. These sensitive habitats, their plant and animal communities, have a direct link with other habitats and waterways, affecting entire ecosystems. The goal is to preserve these areas to the fullest possible extent, for the preservation of these species and for the good of the community.

There are many regulations regarding working in these areas, and therefore, multiple federal, state, and/or local permits may be required. For further information, contact

the Developmental Services Department or refer to the City or Bellevue Land Use Code.

### **Water Quality Monitoring**

Water quality is another important aspect for maintaining a healthy park system and urban environment. In Bellevue, many departments and outside agencies work together and communicate with Bellevue Parks to ensure that monitoring and regulation of water quality and surrounding habitat persists. These include Bellevue's Developmental Services Department, Utilities Departments, the Washington State Department of Ecology, and the Washington State Department of Fish and Wildlife.

### **Riparian Corridors**

Riparian corridors are sensitive areas that include an interactive vegetation community integrated with a water course ecosystem which provides food, shelter, breeding and rearing areas for aquatic and terrestrial animals and birds. They encompass the area that runs along both sides of the water body, ranging from 10 - 50 feet wide, depending on the sensitivity classification. Included are wetlands and meadows.

- Improper clearing can have serious effects on the ecosystem, allowing for increased runoff, toxin accumulation, oxygen reduction to surrounding plants and water systems, and overall habitat destruction.
- Native vegetation is usually preserved or planted to mitigate any negative effects.
- If the corridor is located within a Native Growth Protection Area (NGPA), it must be registered with the City of Bellevue.

### **Shoreline and Bank Stability**

Reinforcing or protecting a shoreline should consider the least impact necessary to achieve reasonable stability. These practices include, but are not limited to:

- Traditional use of riprap should be used only as a last resort. Softer treatments, such as log placement and bioengineering plantings, are preferred where feasible and practical.
- Treatments should consider seasonal differences, such as the Chittendon Locks operations, and regular seasonal water level changes.

### **Steep Slopes**

Steep slopes are defined as any slope over 40% and are considered sensitive or critical areas. An exception are areas of colluvial or landslide deposits, in which case the minimum slope is 15% or greater. The surface slope, soil layers and ground water layers all can impact how stable a slope is. To minimize impacts to a slope and the surrounding area:

- Removing vegetation from the ground layer should be minimized and plantings should be stabilized with appropriate bioengineering techniques (e.g. netting, wattling, hydro-mulching, etc.).
- Revegetation should be evaluated so as not to cause more damage or disturbance to soil layers.
- Slide areas, or areas suspected of being slide-prone, should be evaluated by a geotechnical expert before extensive restoration begins.
- Stormwater runoff must be prevented from saturating or loading steep slopes. The appropriate drainage system should be in place and adequately maintained to intercept runoff flows before reaching the slope.

### **Slide Areas**

Slide areas, or those suspected of being slide-prone, shall be evaluated by a geotechnical expert before extensive restoration is initiated. Strategies can be developed to help maintain or even improve slope stability. The standard practice of hydroseeding repaired slide areas is prudent but does not restore stability. To restore stability and prevent further soil erosion, subsurface hydrology must be considered and woody vegetation re-established.

### **Wetlands**

Wetlands are those sensitive areas that are a transition between terrestrial and aquatic systems where the water table is usually at or near the surface, or the land is covered by shallow water.

The plants that inhabit a wetland are hydrophytic, and adapted to living in hydric soils, sometimes underwater. Wetlands serve an important function in that they act as a natural reservoir for stormwater runoff, offer flood control, recharge ground waters and filter toxins that would otherwise find their way into the water table. They also provide necessary habitat for various wildlife species unique to any other habitat type.

Most wetlands found within the Bellevue Parks system are treated as sensitive areas and managed with the goal of maintaining the natural environment with the least amount of impact.

- Only invasive and noxious weeds are controlled through mechanical or cultural methods.
- Approved wetland herbicides are used only when necessary and never near standing water. Such applications are made under an approved Aquatic Noxious Weed Control NPDES General Permit.
- Only native species are planted within a wetland area, unless the wetland is part of one of the agricultural areas that are preserved within the parks system.

- Trails are kept to a minimum and specially designed to decrease habitat disturbance.

### **Meadows**

Meadows serve an important role in natural and sensitive areas. They provide necessary wildlife habitat, reduce flooding potential downstream or in low lying areas, and act as a natural filter as water passes through supplying needed nutrients to the area. The Bellevue Parks & Community Services Department has adopted many restorative and maintenance practices regarding meadows and wetland areas. They include grassland vegetative cover, meadow preservation, meadow restoration, habitat preservation and fire prevention.

### **Grassland Vegetative Cover**

Healthy vegetative cover is important for erosion control, habitat and noxious weed control.

#### **Exotic Grasses**

Most urban meadow sites are previously disturbed sites resulting in regrowth of primarily exotic grasses. Once established, these exotic species should be accepted as the primary component of the vegetative cover.

#### **Native Meadow Plants**

Preservation of native plants should be attempted whenever possible.

#### **Wet Meadows**

Many meadow areas in this region remain in a saturated condition for 6 months or more. Avoiding significant maintenance activities during this period is recommended. Preservation and introduction of appropriate native plants into these sites will help ensure a healthy vegetative cover.

To preserve a grassland, wet meadow or perennial meadow in the Pacific Northwest requires an ongoing maintenance program.

- Disturbance: Avoid creating holes in the vegetative cover because it will open opportunities for noxious weeds to invade.
- Meadow Succession: The natural evolutionary process of forest/meadow succession will eventually colonize meadow areas with shrubs and trees. The management of this process will have a major impact on the character and longevity of the meadow. The desired character of a meadow area should be defined. The meadow should be managed to prevent the establishment of exotic trees and shrubs.
- Exotic Weed and Brush Control: Scotch broom and other noxious weeds colonize many meadow areas, especially if the vegetative cover is weak or not intact. If invasive brush is a minor problem, hand grubbing, use of

weed wrenches or spot spraying with a broadleaf herbicide are options. When invasive brush is a major problem, it may be necessary to mow the meadow on an annual basis. Mowing should be timed to avoid disturbing wildlife. Spring should be avoided to allow protection for ground nesting birds. The site should be monitored for other wildlife activity before mowing occurs. Mowing should also be done before seed set of the targeted species. Mowing heights should be a minimum of 6 inches high to prevent excessive grass clippings and to minimize exposing bare ground.

### Restoration and Construction of Meadows

The restoration or new construction of a meadow should consider the following:

- Hydrologic Study of the Site: Available moisture is the determining factor in appropriate plant selection.
- Soil Study: Many native plants require specific soil requirements to succeed.
- Existing Vegetation: The site should be assessed for desirable species as well as undesirable species. A small test plot can also help determine the potential weed seed bank in the soil profile. A thorough inventory of existing species can provide valuable information for selection of appropriate species.
- Natural Succession: Whenever possible, attempt to emulate the natural succession process by initially introducing primarily pioneering plant species and gradually expanding into later successional species as cultural conditions allow.
- Wildlife Habitat: The management practices of meadow areas should reflect the goal of preserving and enhancing desirable wildlife species.
- Maintenance Activities: Maintenance activities should be evaluated as to their impact on wildlife and appropriate decisions made.
- Enhancements: Many desirable species can be attracted by enhancements such as nesting boxes, brush piles, rock piles, stumps, snags and specific plants.
- Environmental Education/Interpretation: When resources are available, it is important to address environmental education. Educated park users are much more likely to preserve and protect a site.

### Organic Debris

Organic debris from maintenance practices will remain on site, as long as it does not interfere with other landscape functions and/or create a fire hazard. Types of interference include blocking trails, forming unstable cornices, diverting drainages and smothering desirable vegetation. Wherever possible, use the following practices:

- Organic debris should be cut and dispersed to maximize ground contact which helps accelerate decomposition.
- Chipping woody debris is useful as long as debris is left in a depth of 3-inches or less.
- Leave uncut branches and logs in place to restrict traffic into natural areas.
- Stabilize logs to prevent sliding or rolling.
- Remove invasive species from the site.

### **Fire Prevention**

A healthy, diverse plant community is fire resistant, but woody plant debris must be managed in any urban landscape. The following practices encourage fire prevention in natural and sensitive areas:

- Excessive accumulations of dead woody plant debris should be avoided. Thinly scatter this debris away from park use areas.
- If tree pruning or removal debris remains in a native woodland site, the material should be cut, slashed and scattered well enough to directly contact the ground. Ground contact helps expedite the decomposition process.
- Maintain transitions to developed landscapes to provide interruptions to the normal path that fire usually travels. This practice creates a more defensible landscape.
- Hydrants should be located along the edge of natural areas to provide immediate access for firefighting.
- Service roads into large woodland tracts should be maintained to allow access to Fire Department tanker trucks.
- Large woodland tracts with high fire potential should be studied for possible development of service roads.
- Areas of known homeless encampments should be frequently inspected and cleaned up to minimize the potential for wildfires.

## 9.4 Training

- Provide training to all construction personnel to make sure they understand all construction site BMPs, including streambed and bank protection, steep slopes and wetland protection.
- The site manager and other designated site managers shall receive the most recent training and education dealing with construction site

management. This training includes the most recent advances for protecting trees on construction sites.

- Urban forestry and site managers should receive training in appraising and evaluating tree and plant damage according to International Society for Arboriculture standards and natural area preservation techniques.
- Foresters and tree workers shall be ISA certified.
- All contracted or volunteer planting crews shall be trained in proper planting techniques by the site manager.



(This page intentionally left blank)

## CHAPTER 10 – Trail System Management

---



### 10.1 Purpose

Trails play an integral role within the park and open space system. Trails are the most widely used recreational facility managed by the Parks & Community Services Department. They are used and supported by nearly 90% of Bellevue residents. Trails provide non-motorized and recreational opportunities for walkers, bicyclists, joggers, hikers and birdwatchers. They are the string that physically connects parklands, neighborhoods, schools and businesses. Trails also provide staff access for maintenance and management of the park and open space system. Bellevue's trails are designed and constructed in an environmentally sensitive manner to reduce soil compaction, erosion and runoff to protect sensitive areas from degradation.

### 10.2 Background

Bellevue's trail program oversees trail planning and development, project management, development mitigation, workload planning and maintenance of over 98 miles of pedestrian, equestrian and multi-purpose trails located on park property and public easements. Attention to trail planning and design has resulted in a system of pathways which provides a spectrum of opportunities for different users.

Bellevue's trail system provides a physical link for residents to value and appreciate the natural attributes of our open space and greenway system. Trails are constructed in a manner that minimizes the impact of human traffic in park natural areas and protects sensitive wildlife habitat while at the same time enhancing the visitor experience. Human contact with nature fosters community support for the overall goals and objectives of the city's park and open space system plan and the natural resource management program.

### **Trail Design and Construction**

Trail construction is guided by park development standards that consider drainage, slope, width, clearing limits, surface material and habitat value. The use of geotextiles on trail surfaces and water diversion BMPs provides effective drainage, soil stabilization and weed control. Stair and boardwalk construction provides access through narrow corridors, over wet ground and on steep slopes with less impact than traditional trail structures. The following considerations are reviewed based on site conditions and constraints.

### **Design Elements in Wetlands**

Design and implementation of trails in a wetland environment requires consideration of certain risks associated with this type of sensitive area, such as:

- Water quality impacts
- Sedimentation
- Introduction of toxins
- Increase in nutrient loading
- Changes in pH, salinity and oxygen balance
- Increases in suspended and dissolved solids and turbidity
- Impediment of movement of stormwaters (including soil compaction)
- Habitat impacts
- Fish and wildlife disturbances
- Aesthetic impacts
- Illicit access off developed trails (social trails)

To minimize impacts from trails in a wetland:

- When possible, higher ground shall be chosen for trail location.
- Stream crossings shall be at a minimum, but if necessary, shall be done at 90 degree angles.
- Culverts or bridges, if necessary, shall be used in such a way that the existing drainage will not be altered and passage for fish will not be affected.
- Culvert size is based upon maximum stream flow and site conditions.

- Streambanks and other sensitive areas will be minimally impacted, if at all.
- Geotextile fabric may be used in construction to increase the bearing strength of the trail and minimize fill requirements, disturbance and maintenance costs.
- Trail grades should range from 0 to 6% with a 3% or less side slope to ensure adequate drainage, minimize surface water velocities and discourage rutting and erosion. Based on site conditions and site constraints, trails may be constructed with grades ranging from 15% to 20%. Steeper grades may require stairs to avoid erosion and other site impacts.

### **Design Elements in Upland Park Sites**

Consideration shall be given regarding impact on neighboring properties, drainage, slope, width, clearing limits and surface materials for each individual park.

- If narrow corridors are present, stairs shall be considered.
- Steep slopes and wet areas shall be avoided, if possible, for trail development. If necessary, stairs and/or cantilevered boardwalks shall be utilized to decrease surface impact.
- Trail width shall be a minimum of 4 feet. Steeper upland sites may only allow for 3 feet due to topographical constraints.
- Trails should follow slope contours to decrease disturbance as much as possible.
- Trail slope shall be based on site conditions and decided upon by the site manager.
- Trail grades should range from 0 to 6% with a 3% or less side slope to ensure adequate drainage, minimize surface water velocities and discourage rutting and erosion. Based on site conditions and site constraints, trails may be constructed with grades ranging from 15% to 20%. Steeper grades may require stairs to avoid erosion and other site impacts.

## 10.3 Best Management Practices

### **Bark Trails**

- Prior to surfacing, trails shall be manually grubbed out taking care not to disturb surrounding vegetation. Native plant species that occur within the proposed trail alignment will be transplanted on site as part of the trail construction process. Trail surface retaining poles may be used in areas

- that are prone to sloughing and erosion, usually on the outsides of corners and in areas of grade change.
- Woody debris removed from the trail grade will be randomly scattered on site and will be left in ground contact oriented across slope. On sites with a high volume of debris during construction, mobile on-site chipping will be implemented and resulting chips will be used as an underlayment trail surfacing material.
  - All trail work will be conducted within trail alignment to minimize side of trail disturbance and degradation.
  - Surface drainage techniques shall be utilized, such as:
    - Crowning
    - In-sloping and out-sloping at 3% or less grade
    - Culvert installation
    - Slope exposed gutters.
    - Turn pike/ French drain systems.
  - Trails shall maintain a 2-foot minimum horizontal clearance to any obstruction.
  - Trails shall maintain a 7-foot minimum vertical clearance from trail surface, across the horizontal clearance width.
  - Side-slope shall be graded no greater than a 3:1 slope and covered with jute fabric and stapled. Grading shall be done so that accumulation of runoff does not collect at bottom of slope. A 2-foot-wide transition edge is required prior to start of side-slope. Where required, toe of slope exposed gutters are used to route trail water runoff to culverts.
  - Geotextile fabric shall be laid between subgrade and base course prior to surfacing, where needed. This is applicable to wetland sites and sites that have a soft base.
  - Subgrade shall consist of undisturbed native soil. Subgrade shall never be compacted.
  - Surface shall be grubbed to level trail grade to 3% or less to ensure trail drainage.
  - Trail surfacing shall consist of medium fine bark applied to a depth of 4 inches and raked out smoothly. If necessary, the area adjacent to trail shall be revegetated or properly landscaped with native shrub, tree and groundcover species.
  - Trailheads will have developed signage, and if necessary, post and rail fencing along with a native shrub/tree palette (see associated standard details and/or specifications).

## Crushed Rock/Gravel Trails

- Prior to surfacing, the trail shall be manually grubbed out taking care not to disturb surrounding vegetation. Native plant species that occur within the proposed trail alignment will be transplanted on site as part of the trail construction process. Trail surface retaining poles may be used in areas that are prone to sloughing and erosion, usually on the outsides of corners and in areas of grade change.
- Woody debris removed from the trail grade will be randomly scattered on site and will be left in ground contact oriented across slope. On sites with a high volume of debris during construction, mobile on-site chipping will be implemented and resulting chips will be used as an underlayment trail surfacing material.
- All trail work will be conducted within trail alignment to minimize side of trail disturbance and degradation.
- Surface drainage techniques shall be utilized, such as:
  - Crowning
  - In-sloping and out-sloping at a 2% grade
  - Culvert installation
  - Slope exposed gutters
  - Turn pike/ French drain systems
- Trails shall maintain a 2-foot minimum horizontal clearance to any obstruction.
- Trails shall maintain a 7-foot minimum vertical clearance from trail surface, across the horizontal clearance width.
- Side-slope shall be graded to a 3:1 slope when possible. Grading shall be done so that accumulation of run-off does not collect at bottom of slope.
- Geotextile fabric is not usually used in park rock/gravel trails.
- Subgrade shall be 5/8-inch crushed rock, compacted to 95% density. Disturbed native soil subgrade should be compacted to 95% density.
- Surfacing base shall be 4 inches of 5/8 minus crushed rock. The trail surface shall be 2 inches of compacted 3/8 minus crushed rock.
- If necessary, the area adjacent to trail shall be revegetated or properly landscaped with native shrubs, trees and groundcover species.
- Trailheads will have developed signage, and if necessary, post and rail fencing along with a native shrub/tree palette (see associated standard details and/or specifications).

## Asphalt Trails

- Prior to surfacing, the trail shall be grubbed out by mechanical or manual means. Any areas adjacent to the trail where vegetation was removed or damaged shall be replanted with native species.
- All hazard trees and tree limbs shall be removed from trail site.
- Subgrade shall consist of undisturbed native soil. If soil is disturbed, soil shall be compacted to 95% density.
- Geotextile fabric shall be laid between subgrade and base course.
- Root barrier, if necessary, shall be installed prior to installation of asphalt. Root pruning, when necessary, shall be done by an ISA Certified Arborist.
- Side-slope shall be graded to a 3:1 slope, when possible. Bottom of side-slope shall be graded to prevent accumulation of run-off.
- The trail surface slope shall be a maximum of 3%. Edges shall be thickened to 6 inches deep by 10 inches wide for erosion protection.
- Trees shall be maintained for a 7-foot vertical clearance from trail surface, across the horizontal clearance width. Equestrian trails shall be maintained for a vertical clearance of 10 feet.
- Unless otherwise specified, asphalt top course shall be class "B" asphalt with a minimum thickness of 2.5 inches, and a maximum thickness of 4 inches.
- Base course shall be 5/8 inch minus crushed rock, compacted to 95% density, with a minimum thickness of 4 inches.
- Trail width shall be between 4-14 feet, depending on site conditions and designed functionality. Wider trails are not usually installed in Bellevue parks, but consideration will be made if necessary.
- If necessary, the area adjacent to trail shall be revegetated with native shrubs, trees and groundcover species. If the trail crosses a turf area, disturbed turf shall be replaced.
- Trailheads will have developed signage, and if necessary, post and rail fencing along with a native shrub/tree palette (see associated standard details and/or specifications).

## Stairs, Boardwalks & Retention Peeler Poles

- All trail structures will be constructed to Parks & Community Services standards and specifications.
- All treated wood materials used for construction shall not leach hazardous materials and will be dark tinted ACQ/CBA pressure treated.
- All rough sawn and dimensional wood shall be of HEM-FIR #2 grade or better. All wood used for railings will be appearance grade non-incised.
- Boardwalk footings and stairs shall be placed on stable subgrade.

- Landings shall be composed of fill consisting of 3/8" minus crushed rock, compacted by hand. Railings will be used if edge is 30 inches or greater from grade or is deemed necessary. Railings shall be installed on the right-hand side heading upstairs.
- Trail retention peeler poles and stakes shall be lodge pole pine with ACQ/CBA treatment.

## 10.4 Training

All maintenance crew members are trained in proper trail planning, design, construction and maintenance. Crew members and staff are also trained ISA Certified Arborists and WSDA licensed pesticide applicators.



(This page intentionally left blank)

## CHAPTER 11 – Agricultural Areas



### 11.1 Purpose

The City of Bellevue Parks & Community Services Department manages the last remaining farmlands within the city. These lands are comprised of approximately 42 acres and are located in the rich peat soils of the Lake Hills Greenbelt and Mercer Slough Nature Park. These farmlands were established in the late 19<sup>th</sup> and early 20<sup>th</sup> centuries after clearing and draining opened the land for agriculture. Today these historic agricultural lands help preserve Bellevue’s agricultural past, provide community gathering spaces and increase wildlife habitat. The continued management of these agricultural lands is identified as a component of the master plans for each park. They are managed as farmed wetlands in an environmentally sensitive manner under the same set of multiple use goals consistent with other open spaces land to maximize public benefits.

### 11.2 Background

All remaining agricultural lands within the city are located within the Lake Hills Greenbelt and Mercer Slough Nature Park. Agriculture in the Lake Hills Greenbelt was established in the late 19<sup>th</sup> century when early pioneers drained the land between Larsen and Phantom lakes by diverting natural flows into Lake Sammamish.

Agriculture in the Mercer Slough Farm was established shortly after the creation of the Chittenden Locks lowered the level of Lake Washington 9-12 feet in 1917. The blueberry farms were established in the 1940's. Current city managed farms include the following:

- Larsen Lake Blueberry Farm (14 acres)
- Lake Hills Greenbelt Truck Farms (10 acres)
- Mercer Slough Blueberry Farm (18 acres)

## **Existing Site/Environmental Conditions**

### **Current Landscape and Field Condition**

All agricultural fields are located in wetlands associated with the Kelsey Creek drainage that have been converted to agriculture during the late 19th and early 20th centuries. The condition of current plant material may be a good indicator of existing cultural conditions. Master plans, soil types, moisture regimes, nutrient levels and types of pest populations determine farm renovation and plant selection options. Because of the wet soil condition and low air circulation associated with these sites, special attention must be given to cultural practices to help reduce root-rotting fungus such as *Phytophthora* and berry-infecting fungus such as *Monilinia vaccinii-corymbosi* (Mummy berry).

### **Soil Type and Condition**

Soil type can ultimately determine the longevity, mortality and health of the crop plants. The soils that make up both farms are predominately peats and/or mucks. Although blueberries like wet and acidic soil conditions, excessive water may cause root rot problems and must be carefully monitored and controlled through drainage.

### **Drainage**

Because of the high water table that exist at both sites, irrigation is typically not necessary. Drainage, however, is essential in helping to prevent disease and allowing access to the fields for maintenance activities. The maintenance of existing ditches and cross tiles is essential to help maximize yields and reduce disease.

### **Cultural Conditions**

Cultural conditions such as existing plant health, soil, moisture, sunlight, wind, rainfall, pests and disease all have an important role in plant health. Environmentally sensitive cultural practices such as mowing, weeding, pruning, mulching, pollination and drainage are used to increase plant vigor.

**Safety**

The safety of Bellevue residents and farm workers is paramount in farm operations. Designation of U-pick areas, adequate signage, plantation design, plant maintenance, proper materials storage, harvesting coordination and elimination of undesirable pest populations all help to create a safe environment.

**Cultivar Selection/Diversity**

Species diversity offers a longer harvesting season and cross-pollination. Monocultures can be more susceptible to total failure in case of insect or disease problems.

## 11.3 Best Management Practices

The farms are components of Master Plans for both the Lake Hills Greenbelt and Mercer Slough Nature Park. BMPs for farm operations take into account the multiple use aspects of the parks and utilize environmentally sensitive cultural practices to help maximize public benefit and protect the environment. The uses of pesticides on the farms are extremely limited and, although not certified, the farms are operated using organic farming techniques.

Major horticulture decisions regarding blueberry farms include nutrition, water management, pruning, pollination, harvesting, and weed and pest management. Many cultural operations are timed to the annual growth cycle of the plants, which varies from year to year with climate and soil conditions. Table 11.1 shows a typical blueberry yearly calendar planning guide. It should be noted, however, that the use of pesticides will be only considered as a last alternative.

**Table 11.1** Annual planning guide for blueberry fields

Growth Period	Approximate Dates	Cultural Operations
Dormant	Nov.—mid March	Prune, apply dormant spray for scale growth if necessary, apply copper for bacteria canker if necessary and remove diseased and winter-injured tissue.
Leaf and flower bud break	Late March—late April	Apply fungicide for primarily mummy-berry if needed, control weeds and apply copper if needed.
Bloom Period	Late April—late May	Apply fungicides for mummy-berry if needed, apply insecticides to control aphids if needed, introduce bees for pollination.
Fruit Development	June and July	Cultivate or spray for weed control in between rows, install bird damage control devices.
Harvest	July—Sept.	Harvest and market fruit.
Post-harvest Growth	Sept.—mid October	Cultivate to control weeds, remove bird damage control devices.

## Water Management

Blueberry plants have most of their effective root system in the upper 18 inches of soil. Normally, this would subject the plants to drought injury in the hot summer months when water availability decreases, however, the Lake Hills Greenbelt and Mercer Slough farms are located within wetlands comprised of hydric, peat soils which essentially eliminates the need for irrigation. The need for adequate drainage, however, becomes increasingly important for maintaining plant vigor.

Water management at the Mercer Slough farm faces additional drainage issues. Mercer Slough is an adjacent wetland to Lake Washington and the water level is artificially controlled by the Army Corps of Engineers through the operation of the Chittenden Locks in Seattle. The water level manipulation by the Corps creates a reverse hydrological effect in the wetland, keeping the level artificially higher in the summer months. This artificial hydrologic environment further exacerbates drainage issues that contribute to root rot and mummy-berry.

To assist with drainage, the slough was dredged in the early 20<sup>th</sup> century and an earthen dike running parallel to the channel was constructed. Individual blocks of berries are separated by dammed drainage ditches that flow east into the channel. Cross tiles running perpendicular to the drainage ditches pull ground water from the fields into the ditches. Water is pumped out of the ditches into the Mercer Slough via two lift stations with two, 3 phase, 230 volt trash pumps in each station. These pumps have a pumping capacity of approximately 360 gallons/min through 4" PVC pipes. These pumps utilize float valves triggered by rising water levels to control water levels. They also have the ability to grind up small woody debris to prevent clogging. Proper water management helps ensure fruit production, good floral initiation for next year's crop and that fruit skin moisture is maintained to prevent cracking or shriveling.

## **Pruning**

Annual pruning is essential to maintain blueberry plant vigor, increase productivity, aid in pest management, maintain fruit quality and develop appropriate growth habits. Annual moderate pruning produces bushes with the fewest canes, but greatest yields. Proper pruning balances the production of new wood while maintaining fruit production. Although the best time to prune is during late winter dormancy as carbohydrates produced in late fall have had sufficient time to be stored and winter injured wood can be easily removed, blueberries can be pruned anytime between the end of fall harvest and spring bud break. Disinfect loppers and pruners between bushes to help prevent the spread of disease.

### **Pruning Technique**

Pruning with newly established plantings (1-2 years old) will primarily be directed at shaping the plant into an upright habit and encouraging new vegetative growth and vigor. Remove the older, twiggy growth from the base of the plants and strip blossoms off to accelerate plant and root growth.

In subsequent years (2-5), prune lightly to remove injured wood and twisted or low growing canes to promote new growth. Remove all but 2-3 newly produced canes at crown level. At 7 years old, plants should have 10 – 20 canes of different ages.

Pruning mature plants consists of cutting out old, larger, low producing canes and eliminating weak, twiggy growth in the top or outer areas of the bushes to facilitate aeration and encourage increased budding and large berries. In very mature neglected plantings, it may be beneficial to simply crown prune the entire plant at the base and start from scratch. The following represents a systematic approach to pruning:

- In older plantings, remove 20% of older wood to stimulate new shoot growth.
- Remove low growth that would touch the ground when loaded with fruit.
- Cut off excess new growth that you don't want to develop.
- Remove any damaged canes and twigs.
- Cut out weak, twiggy growth from the top and outer parts of the plant to allow for light penetration and aeration through the plant.
- Prune to shape plant for appropriate harvest method (machine vs. hand picking).

## **Pollination**

Although blueberry bushes are capable of setting fruit on 100% of their flowers, 80% is considered a full crop. The conservation of wild bee habitat such as fallen logs, ditch banks and natural areas close to the field enhances wild bee populations. Honeybee pollination, however, is essential for sustainable yields. The following standards ensure a high probability that proper pollination will occur:

- Make sure the crop is an attractive crop. This entails making sure that pruning cultivates plants with high bud counts, and the chosen cultivar has desirable corollas (shorter corollas have proven to be more attractive to honeybees than longer corollas).
- Ensure that there are at least 4-8 bees/plant at any time during the warmest part of the day during bloom.
- Hives must be in place when a minimum of 5% and a maximum of 25% of the flowers have opened.
- Hives must be placed in a wind-sheltered sunny location and preferably facing East.
- Proper pollination requires a minimum of 1-3 hives/2 acres, depending on cultivar.
- Hives should be distributed evenly throughout the field: 300ft. apart along every 10th row.
- Remove all competition from plant areas (e.g. dandelions, clover, etc.)
- Additional efforts to encourage native mason bee population are also utilized.

## **Harvesting**

U-pick and hand harvesting are done in both the Lake Hills Greenbelt and Mercer Slough Nature Park blueberry fields. Clearly designate blocks, varieties and U-pick areas for the public.

## Diseases

- Disease problems shall be accurately identified and management strategies shall be tailored to actual diseases present in the field in current season.
- Disease resistant cultivars shall be used when planting new sites.
- Mummy-berry incidence and severity shall be documented and mapped (noting varietal differences) by determining number of strikes/bush for primary infection and percent infected fruit for secondary infections.
- One or more of the following strategies shall be used to suppress primary infection of mummy-berry (where needed):
  1. Apply a thick layer (3-4") of organic mulch beneath bushes to cover fallen fruit in mid-spring.
  2. Rake, disk or cultivate soil beneath bushes in spring prior to budbreak to disrupt mummy-berry spores.
  3. Apply 200 lbs/acre 50% urea pills beneath plants in spring prior to budbreak to 'burn' mummy-berry spores. Despite a strong offensive, Lime Sulphur may also be effective at burning spores.
- Diseased wood shall be pruned and destroyed. Pruning tools shall be sanitized between cuts.

## Insects

- Insect problems shall be accurately identified and management strategies tailored to actual insect pests present in the field in the current season.
- Insects that vector viral and MLO diseases (e.g. aphids and leafhoppers) shall be controlled, if necessary.
- Other insect pests (e.g. leaf rollers, gypsy moth, sawfly, Japanese beetle, spotted wing drosophila) will be monitored and controlled, if necessary.

## Weeds

- Noxious weeds will not be tolerated and shall be removed from the sight wherever possible.
- Frequent mowing between rows shall be used to reduce weed competition.
- Invasive weeds may be somewhat tolerated, but shall be controlled through cultural and mechanical methods whenever possible.



## **Vertebrates**

- Bird depredation may be managed with the use of a scare device (usually audio).
- Bellevue Parks does not currently have depredation problems with deer or other large ungulates.
- Rodent depredation is generally tolerated on farm fields, but shall be monitored and controlled if necessary.

## 11.5 Training

Full and part-time crew personnel will be trained on all mowing and weed eating operations as well as correct pruning techniques.

# Glossary of Terms

---

**Agricultural Area** – An area set aside for the use of growing and producing a crop.

**As-built Drawings** – Final drawings of the actual installation of structures, materials and equipment.

**Biological Control** – The use of biological agents, such as insects, to control weeds.

**Block** – A designated number of rows of typically similar crop cultivars.

**Caliper** – An instrument for determining the diameter of a tree.

**Call-Before-You-Dig** – A statewide system that allows contractors to locate underground utilities before construction. This contact is mandatory. The phone number is **1-800-424-5555** or **811**.

**Catch Basin** – A reservoir for collecting surface drainage or runoff. Most catch basins have some storage capacity in the bottom to trap sediments, debris and other particles that can settle out of stormwater.

**Certified Arborist** – An individual who has demonstrated knowledge and competency through obtainment of the current International Society of Arboriculture arborist certification, or who is a member of the American Society of Consulting Arborists.

**Certified Forester** – An individual who has a professional degree from an accredited forestry program and has demonstrated the education and knowledge required by the Society of American Foresters (SAF) to be certified through the SAF Certified Forester Program.

**Chemical Control** – The use of pesticides, both pre-and post-emergent.

**Clean Green** – Refers to various plant debris such as leaves, pruned limbs, etc. that has not been contaminated with garbage and is suitable for recycling and composting.

**City's Storm Drainage System** – A conveyance, or system of conveyances (including roads with

drainage systems, municipal streets, catch basins, curbs, gutters, ditches, manmade channels or storm drains) that are owned by the City or used for collecting or conveying stormwater; which is not combined with sewer; and which is not part of a publicly owned treatment works (POTW).

**Compaction** – An increase in the density of something, through the act of crushing or compressing.

**Construction Site Management** – Refers to the management of construction activities during three phases of site development: pre-construction, construction and post-development. These include BMPs for erosion control, shrubs, trees, drainage patterns and irrigation systems. Tree preservation is a special concern during construction because tree roots can often extend throughout an entire site, and mature trees increase property value.

**Courtesy Strips** – Hard surface strips running parallel to the curb that provide a place for motorists to exit without stepping in the planter strip.

**Critical Root Zone (CRZ)** – Commonly defined as the area between the tree trunk and the outer edge of a tree's canopy, or drip line, where the majority of primary, or critical, roots reside. However, it is important to recognize that root systems vary in depth and spread based on the size of the tree, species, soil conditions, water table and other related factors. A commonly accepted method of calculating the outer edge of the CRZ is by multiplying the measured DBH by 12.

**Crop** – A cultivated plant or agricultural good that produces a yield in a particular season.

**Cultivar** – A variety of a plant that has been created or selected intentionally, from a natural species, and maintained through cultivation. Varieties are created to enhance a specific characteristic, such as the fruit size, disease resistance, ability to withstand frost, color, etc.

**Developmental Services Division (DSD)** – City department that establishes land use and zoning guidelines, provides code enforcement, issues permits and provides inspections for construction, renovation and enhancement projects.

**Diameter at Breast Height (DBH)** – The diameter of the tree trunk at four and one-half feet (or 54 inches) above natural grade level. The diameter may be calculated by using the following formula:  $DBH = \text{circumference at 4.5-feet} \div 3.14$ . To determine the DBH of multi-trunk trees or measuring trees on slopes, consult the current *Guide for Plant Appraisal*, published by the Council of Tree and Landscape Appraisers.

**Disease Control** – The maintenance of healthy plants accomplished by good cultural practices.

**Easements** – BCC 14.60 defines an “easement” as a “grant of an interest in land by the property owner for a designated use by another person or entity or the public in general.” See “Right-of-Way.”

**Edging** – Grass removal along the edges of turf areas.

**Evapotranspiration** – The sum of water lost from the soil surface (evaporation) and the amount of water used by the plant (transpiration).

**Geotextile fabric** – A synthetic woven fabric used to reinforce and support surface materials and enhance drainage.

**Grade** – The degree of inclination of the trail surface, measured from ground/base level. Grade also relates to the degree of trail side slope.

**Hazardous Tree** – A tree that possesses a structural defect which poses an imminent risk if the tree or part of the tree could fall on someone or something of value (target).

**Fertilizing** – The use of organic or inorganic materials to adjust fertility levels in the soil.

**Formal Beds** – Planting beds that may include ornamentals, annuals and perennials as part of a landscape design. Formal beds are often irrigated.

**Informal Beds** – Planting beds that may include native plantings without a formalized landscape design. Informal beds are often not irrigated.

**Insect Control** – The suppression or eradication of harmful insects in the landscape.

**Integrated Pest Management** – A decision-making process to determine if, where, when and how pest problems will be managed. An IPM program includes all potential pest control strategies, but focuses on non-chemical controls whenever possible, in order to perpetuate a sustainable environment.

**Irrigation** – The supply of water to plantings, either through automatic irrigation systems or manual systems.

**Low-Impact-Development (LID)** – A set of principles and design strategies that emphasize conservation, use of on-site natural features and site planning to minimize impervious surfaces, native vegetation loss and stormwater runoff.

**Manual or Mechanical Control** – The use of hand and power tools to remove unwanted vegetation.

**Monitor Tree** – A tree that, because of its value, warrants further monitoring to determine an appropriate management strategy.

**MSDS** – Material Safety Data Sheets or MSDS are prepared by manufacturers of chemical products to relay the necessary safety and protective information to users about the said chemical compounds.

**Mulch Mowing** – Grass clippings left after mowing, that provide nutrients and organic matter to the soils.

**National Pollutant Discharge Elimination System (NPDES)** – Permitting program that is a requirement of the federal Clean Water Act, which is intended to protect and restore waters for “fishable, swimmable” uses. The Federal Environmental Protection Agency (EPA) has delegated permit authority to state environmental agencies. In Washington, the NPDES-delegated permit authority is the Washington State Department of Ecology (DOE).

**Nursery** – A facility for the propagation, growing and storage of plants for use on developed and undeveloped park property.

**Pest** – The word "pest" has been broadly defined in this document to include "injurious" insect species, plant pathogens, noxious or invasive vegetation, vertebrate animals such as rodents, structural pests or any other factor that creates an unhealthy environment for landscapes and structures.

**Pesticide** – Any material including agricultural chemicals, herbicides, insecticides and fungicides, or biological agents applied to a target pest as a control measure.

**Planting Beds** – Planting beds are non-turf, planted areas that include woody plant material such as shrubs, trees and ground covers. Planting beds also include floral color displays containing herbaceous plants such as perennials, annuals and bulbs.

**Plant Materials** – All living plants used in landscape design, including grasses, groundcover, flowers, vines, shrubs and trees.

**Poly-house or Shade House** – Terms for greenhouse-type structure that provides a minimal level of cold weather or sun protection required by nursery crops.

**Project Arborist** – Depending on the situation, the role of Project Arborist as determined by the city may be filled by any number of people, including city staff, ISA or SAF certified staff from third party companies, or qualified staff from landscape architect firms.

**Project Manager** – Refers to either the person assigned to the construction project by the department or the contractor who is responsible for managing the overall project. Project management duties include schedule, budget and related logistics, including construction site management.

**Right-of-Way** – Public land that is open to the general public. In the Definitions section of the Transportation Development Code, BCC 14.60, a Right-of-Way is defined as: "All public streets and property dedicated to public use for streets together with public property reserved for public utilities, transmission lines and extensions, walkways, sidewalks, bikeways or equestrian trails."

**Root Buffer** – A temporary layer of material to protect the soil texture and roots. The buffer shall consist of a base course of wood chips spread over the root area to a minimum of 6-inch depth, capped by a layer of 3/4-inch quarry gravel to stabilize 3/4-inch plywood on top.

**Row** – Straight line of crops placed next to each other possibly designated with a number for easy identification and placement.

**Senior Gardening Staff** – Resource management staff person responsible for managing the nursery. Senior gardeners are "journey-level" positions, possessing a broad range of horticultural knowledge and skills.

**Sensitive Area** – An area mapped or defined in the City of Bellevue Sensitive Area Handbook as a sensitive area including areas of special flood hazard, wetlands, riparian corridors and slopes equal to or exceeding 15 percent.

**Setback** – The distance which a building or other structure is set back from another object deemed to need protection, such as a utility, viewshed, right-of-way or property line.

**Significant Tree** – A healthy evergreen or deciduous tree, 8" in diameter or greater, measured four feet above existing grade (LUC 20.50.046).

**Snag** – Any standing dead tree.

**Soil Compaction** – The compression of soil particles that may result from the movement of heavy machinery and trucks, storage of construction materials, structures, paving, etc. within the *tree protection zone*. Soil compaction can result in atrophy of roots and potential death of the tree, with symptoms often taking 3 to 10 years to manifest.

**Stormwater Pollution Prevention Plan (SWPPP)** – Provides BMPs on how to reduce pollutants in stormwater discharges to comply with the National Pollutant Discharge Elimination Systems (NPDES).

**Street Frontage** – Any part of private or public property which borders a public street or includes a right-of-way easement (BCC 14.60).

**Street Tree** – Any tree or large shrub growing within the public right-of-way or easement. A Right-of-Way Use Permit from the City of Bellevue Transportation Department is required prior to any work on or around these trees.

**Synthetic Turf** – Artificial grass, or synthetic turf, is a man-made product manufactured to look like natural grass. Artificial grass is a carpet-like material used for a variety of indoor and outdoor surfaces and is made of recycled and/or synthetic material.

**Target** – A term used to include people, vehicles, structures or something subject to damage by a tree. A tree cannot be a hazard if a target is absent within the falling distance of a tree or its parts. A defective tree in a non-populated area away from pathways may not be considered a hazard.

**Temporary Erosion & Sedimentation Control (TESC)** – Any temporary measures taken to reduce erosion; control siltation and sedimentation; and ensure that sediment-laden water does not leave the site.

**Threshold (IPM)** – The point at which pest injury can no longer be tolerated without compromising the health or aesthetic value of a plant, ecosystem or other assets of value including human health. Once a threshold is being approached, some control measure may be necessary to suppress pest activity to acceptable levels.

**Topping** – The reduction of a tree's size using heading cuts that shorten limbs or branches back to a predetermined crown limit.

**Trail** – Refers to a formally constructed and maintained pathway or a socially created and non-maintained pathway, going through or connecting destinations.

**Tree Appraisal** – A method of determining the monetary value of a tree as it relates to the real estate value of the property, neighborhood or community. When required, a Certified Arborist or Forester determines the appraisal by adjusting a tree's basic value by its condition, location and species using the most recent edition of the *Guide for Plant Appraisal*, published by the Council of Tree and Landscape Appraisers.

**Tree Protection Fencing** – A temporary enclosure erected around a tree to be protected at the boundary of the tree protection zone. Tree protection fencing should consist of five or six foot high chain link (or construction) fence, mounted on two inch diameter galvanized iron posts, driven into the ground to a depth of at least 2-feet at no more than 10-foot spacing. The fence serves three primary functions: 1) to keep the crown, branch structure and trunk clear from direct contact and damage by equipment, materials or disturbances; 2) to preserve roots and soil in an intact and non-compacted state; and 3) to identify the tree protection zone in which no soil disturbance is permitted and activities are restricted.

**Tree Protection Zone (TPZ)** – The area of ground around the base of the tree, as determined by tree species, size, condition, site history and soil conditions, deemed necessary to ensure the safety and health of the tree during and after construction. As a general guideline, the TPZ should be 1 foot diameter for each inch of trunk diameter. This distance may be increased for older trees with moderate to poor construction tolerances.

**Trenching** – Any excavation to provide irrigation, install foundations, utility lines, services, pipe, drainage or other property improvements below grade.

**Trimming** – Mowing and grass removal in areas that cannot be accessed by large riding mowers.

**Turf** – Any lawn or grasses grown in developed parks, streetscapes or public facilities. Turf areas vary widely in type of use from highly maintained athletic fields and golf courses to rough mow areas.

**U-pick** – Refers to the act of letting the customers pick the amount or type of produce desired. This reduces farm labor costs, assists with bird control, allows for more even ripening and provides a recreational opportunity.

**Vertical Mulching** – Auguring, hydraulic or air excavation of vertical holes within a tree's root zone to loosen and aerate the soil, typically to mitigate compacted soil. Holes are typically penetrated 4 to 6 feet on center, 2 to 3 feet deep, 2 to 6 inches in diameter and backfilled with either perlite, vermiculite, peat moss or a mixture thereof.

**Weed Control** – The control of undesirable plant species.

**Water Management** – Term for the efficient use of supplemental irrigation water required for most landscapes in the Puget Sound region.

**Warning Sign** – A warning sign shall be prominently displayed on each fence. The sign shall be a minimum of 8.5 x 11-inches and clearly state: "WARNING – *Tree Protection Zone* - This fence shall not be removed and any injury to this or these trees is subject to penalty according to BCC 14.06.100."

(This page intentionally left blank)

# References

---

Some of the information found in this manual has been based on materials extracted from the following sources:

- American Society of Landscape Architects (ASLA) - [www.asla.org](http://www.asla.org)
- City of Seattle, Department of Parks & Recreation - [www.seattle.gov/parks](http://www.seattle.gov/parks)
- Environmental Protection Agency (EPA) - [www.epa.gov](http://www.epa.gov)
- International Society of Arboriculture - [www.isa-arbor.com](http://www.isa-arbor.com)
- Irrigation Association (IA) - [www.irrigation.org](http://www.irrigation.org)
- King County Noxious Weed Control Board - [www.kingcounty.gov](http://www.kingcounty.gov)
- National Arbor Day Foundation (NAF) - [www.arboday.org](http://www.arboday.org)
- National Recreation and Park Association (NRPA) - [www.nrpa.org](http://www.nrpa.org)
- Society of American Foresters (SAF) - [www.safnet.org](http://www.safnet.org)
- Washington Department of Ecology (DOE) - [www.ecy.wa.gov](http://www.ecy.wa.gov)
- Washington Department of Fish and Wildlife (WDFW) - [wdfw.wa.gov](http://wdfw.wa.gov)
- Washington Food and Drug Administration (WFDA) - [www.fda.gov](http://www.fda.gov)
- Washington State Department of Agriculture (WSDA) - [agr.wa.gov](http://agr.wa.gov)
- Washington State Department of Natural Resources (WDNR) - [www.dnr.wa.gov](http://www.dnr.wa.gov)



(This page intentionally left blank)

# Appendix 1 - Water Shortage Response Plan

---

*The following information details the water shortage response plan specific to sites managed by the Bellevue Parks & Community Services Department. For information regarding the citywide water shortage response plan, please see the latest version of the City of Bellevue Utilities Water Shortage Contingency Plan (WSCP).*

The Bellevue Parks & Community Services Department, in cooperation with the Bellevue Utilities Department, has adopted an aggressive, proactive response plan to meet the demands of our current regional water shortage. The actions outlined in the Parks Water Shortage Response Plan, based on practices implemented during drought conditions in 1992, 2001, and 2015, will allow the department to meet all our conservation goals, and model desired behavior for the community. We encourage others to adopt similar procedures and conservation measures as they may apply. Together we can minimize impacts to our landscapes, and our daily lives, during these challenging times.

This water shortage response plan serves as our immediate response to the Voluntary Stage of phased curtailment of water consumption. It will reduce normal irrigation use by 15%. It allows us to protect our investment in expensive trees and shrubs, and the many benefits they provide, while dramatically reducing irrigation to turf areas.

This plan meets water conservation goals while still allowing select green spaces for the public to enjoy. It has built-in flexibility to reduce irrigation consumption should the water crisis escalate or resume typical managed irrigation should regional supplies allow. The Parks & Community Services Department will work closely with the Bellevue Utilities Department to monitor regional water supplies and respond to any changes that occur.

## **BACKGROUND:**

The City of Bellevue has had an active Water Conservation Program in place for over 30 years. It is an integral facet of our planning processes and our Parks Capital Improvement and Renovation Plan. Historically, water conservation has been taken into careful consideration during the design and planning of all park construction and renovation projects. Parks are designed to require a minimal amount of maintenance, which includes watering.

## **WATER USE IN PARKS:**

- The Bellevue Parks & Community Services Department manages over 2,700 acres of public property. Only about 16% (approx. 445 acres) is irrigated by domestic water supply.
- Over two thirds of the park and open space system is comprised of undeveloped natural areas that don't require supplemental irrigation.
- The Bellevue Golf Course is irrigated using an on-site well and reservoir system.
- Newcastle Beach Park and Clyde Beach Park are irrigated by pumping water from Lake Washington through an approved permit with the Washington State Department of Ecology.
- Irrigation at the largest park sites is efficiently controlled through a central computer system linked to an on-site weather station. The system calculates the evapotranspiration (ET) rate for any given period and delivers only the proper amount of water, eliminating waste.
- Most water features in our parks are recirculating systems.
- Plumbing fixtures in all parks and city facilities are low flow/low volume fixtures.

In 1992 and 2001, Bellevue found itself in the midst of a drought situation that resulted in mandatory water rationing. During those events, the Parks & Community Services Department implemented water conservation measures that resulted in a significant reduction in water consumption. Since that time, we have made many system improvements that enable us to control irrigation on plant zones and reduce the risk of tree and shrub loss in city managed parks and streetscapes. Initial drought response efforts will affect turf areas that are less costly to renovate than trees and shrubs. Select green spaces will still be preserved selectively throughout our system for residents to enjoy.

The following describes in more detail the specific conditions that will apply to the four stages of the Parks & Community Services Water Shortage Response Plan.

## **PLAN IMPLEMENTATION**

When there is notice of a drought emergency, Parks & Community Services will implement a Water Shortage Response Plan. The Parks & Community Services Department will manage the city's park resource system according to the following guidelines until the Utilities Department determines that water supplies are adequate to resume additional irrigation in parks. This plan is designed to provide flexibility to modify park irrigation usage up or down as the drought conditions become more or less severe.

## **PHASE 1 – ADVISORY STAGE**

Irrigation systems will be programmed to reduce irrigation to turf and planting areas on streetscapes, utility sites, and city parks except as designated below. These measures, expected to reduce system-wide water use by up to 15%, will remain in effect until the water supply forecast improves. Activated irrigation systems are proactively monitored and tested to ensure that system watering times and amounts are functioning efficiently with no breaks in underground lines. During this stage you may see irrigation systems within the park system operating during the daytime for testing and system repair.

Turf Area Exceptions: Reduced irrigation (95% of evapotranspiration rate) at:

- Inner circle of Downtown Park
- Chism, Clyde, Enatai, Meydenbauer, and Newcastle Beach Parks
- Robinswood Park - lawn between house and pond, Cabana lawn
- Newly planted turf areas that are not fully established
- Athletic fields – minimal watering for safety
- Crossroads Park

## **PHASE II - VOLUNTARY STAGE**

Irrigation systems will be programmed to reduce irrigation to turf and planting areas on streetscapes, utility sites, and city parks except as designated below. These measures, expected to reduce system-wide water use an additional 10%, will remain in effect until the water supply forecast improves.

Turf Area Exceptions: Reduced irrigation (90% of evapotranspiration rate) at:

- Inner circle of Downtown Park
- Chism, Clyde, Enatai, Meydenbauer, and Newcastle Beach Parks
- Robinswood Park – House Cabana and lawn between House and pond
- Newly planted turf areas that are not fully established
- Athletic fields – minimal watering for safety
- Crossroads Park
- The water feature at the Lake Hills Ranger station will be shut off.

New projects not under contract will be deferred.

## **PHASE III – MANDATORY STAGE**

Phase III actions will further reduce irrigation by an appropriate percentage of the estimated total in accordance with supply forecasts. Bellevue Golf Courses - irrigate greens and tees; reduced irrigation (90% of estimated total) on fairways.

Streetscape, utility sites and park site turf area irrigation will be shut off except those sites designated below. Shrubs and trees will be irrigated by hand or with updated,

efficient irrigation systems such as drip, bubbler or computer-controlled systems designed to separate turf areas from tree and shrub zones. The goal is to keep tree and shrub bed plant material alive to protect the public's investment.

In addition, water use will be reduced at park water features as designated below.

#### Park Water Features:

- Downtown Park - Belvedere fountain will be turned off.
- Downtown Park - canal will remain operating (recirculating system) in order to maintain water quality. Signage advising park visitors of the new hours will be posted.
- Downtown Park - waterfall operation hours will be reduced. Signage advising park visitors of the new hours will be posted.
- Downtown Park - spray park hours will be reduced. Daily operation will be from 12:00pm to 7:00pm. Signage advising park visitors of the new hours will be posted.
- Crossroad Park - spray park hours will be reduced. Daily operation will be from 12:00pm to 7:00pm. Signage advising park visitors of the new hours will be posted.
- Bellevue Botanical Garden - water features will operate daily from 8:00am to 4:00pm. Signage to educate park visitors about the water conservation efforts will be posted.

Turf Area Exceptions: Reduced irrigation (85% of evapotranspiration rate) at:

- Inner circle of Downtown Park
- Chism, Clyde, Enatai, Meydenbauer, and Newcastle Beach Parks
- Robinswood Park - House Cabana and lawn between House and pond
- Newly planted turf areas that are not fully established
- Athletic fields – minimal watering for safety
- Crossroads Park
- The water feature at the Lake Hills Ranger station will be shut down.

#### **PHASE IV – EMERGENCY CURTAILMENT STAGE**

During Phase IV, shrubbery and planter bed irrigation systems will be shut off and/or significantly reduced (with the exception of the collections at the Bellevue Botanical Garden). Tree irrigation will be reduced and monitored, "survival watering", with the use of manual watering or through appropriately zoned irrigation systems.

Lawn irrigation at exempted parks will be further reduced and/or shut off on an incremental basis dependent upon the severity of the water shortage and demand reduction needed, as determined by the Utilities and Parks & Community Services

Departments. Further restrictions on water features will be implemented, or features will be shut off.

- Downtown Park Center Circle
- Chism, Clyde, Enatai, Meydenbauer, and Newcastle Beach Parks
- Robinswood House Cabana area lawn
- Bellevue Botanical Garden plant collections
- Athletic field activity areas
- Crossroads International circle

**CONTACTS:**

Parks & Community Services Department: (425) 452-6855

Utilities Department: (425) 452-4127

(This page intentionally left blank)

## Appendix 2 – Standard Detail Drawings

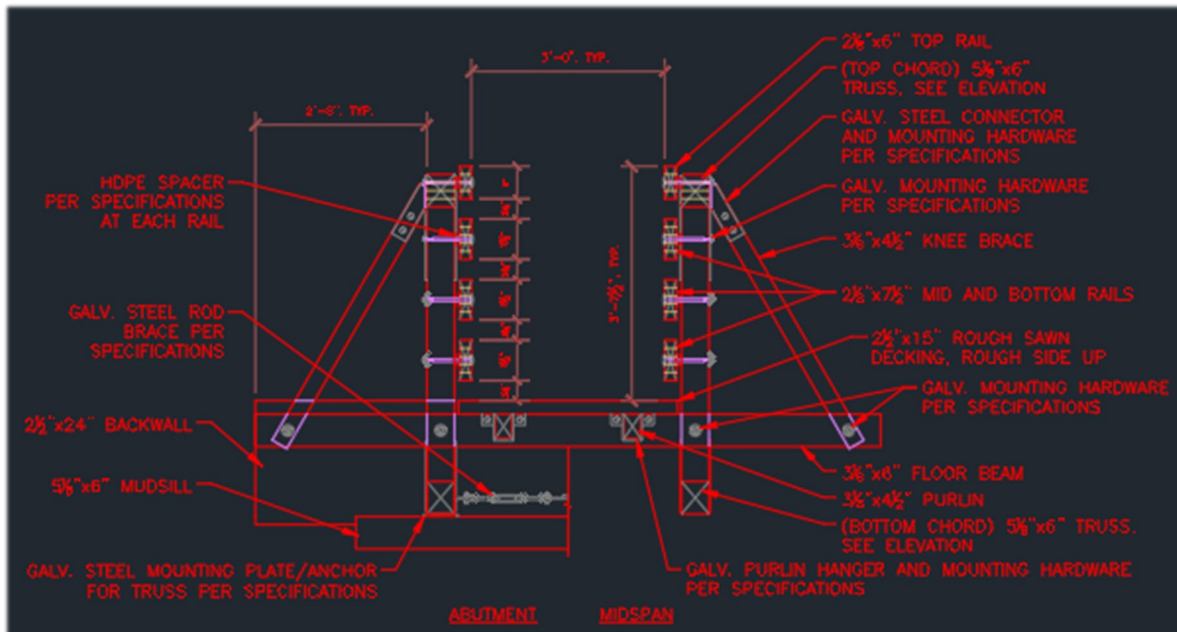

The following inventory of standard detail drawings is up to date as of November 2023. To obtain copies of the most current drawings, visit the City of Bellevue's [Environmental Best Management Practices](#) website. To request the associated CAD (.dwg) file, please contact Parks & Community Services at (425) 452-6855 or at [parksweb@bellevuewa.gov](mailto:parksweb@bellevuewa.gov).



(This page intentionally left blank)

# Signs

---



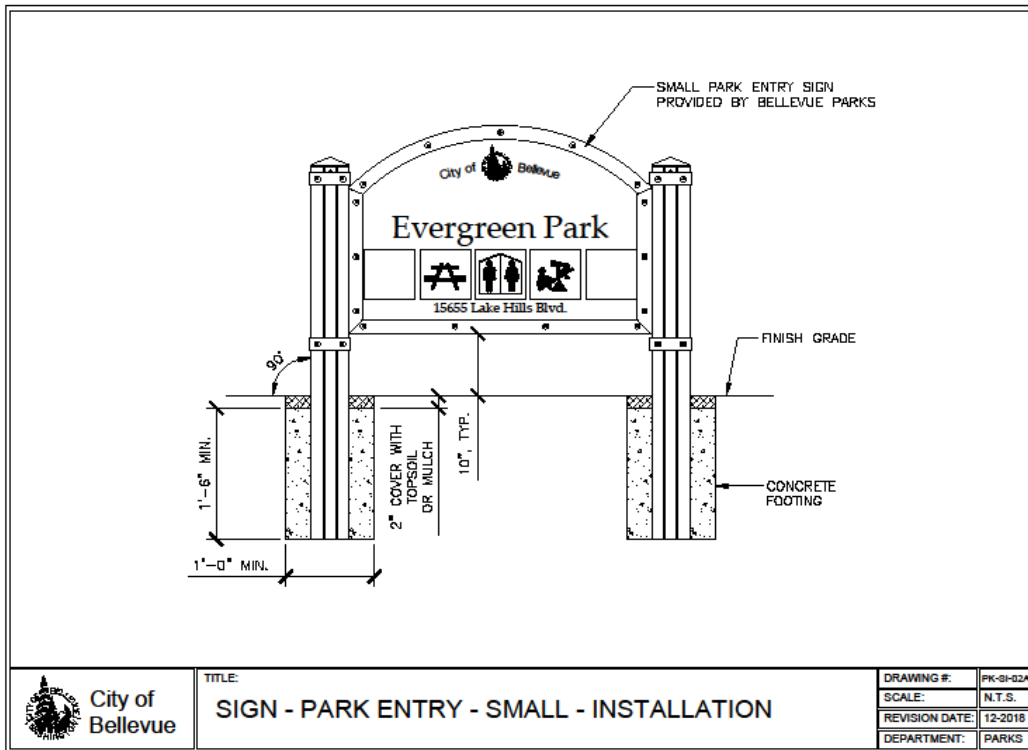
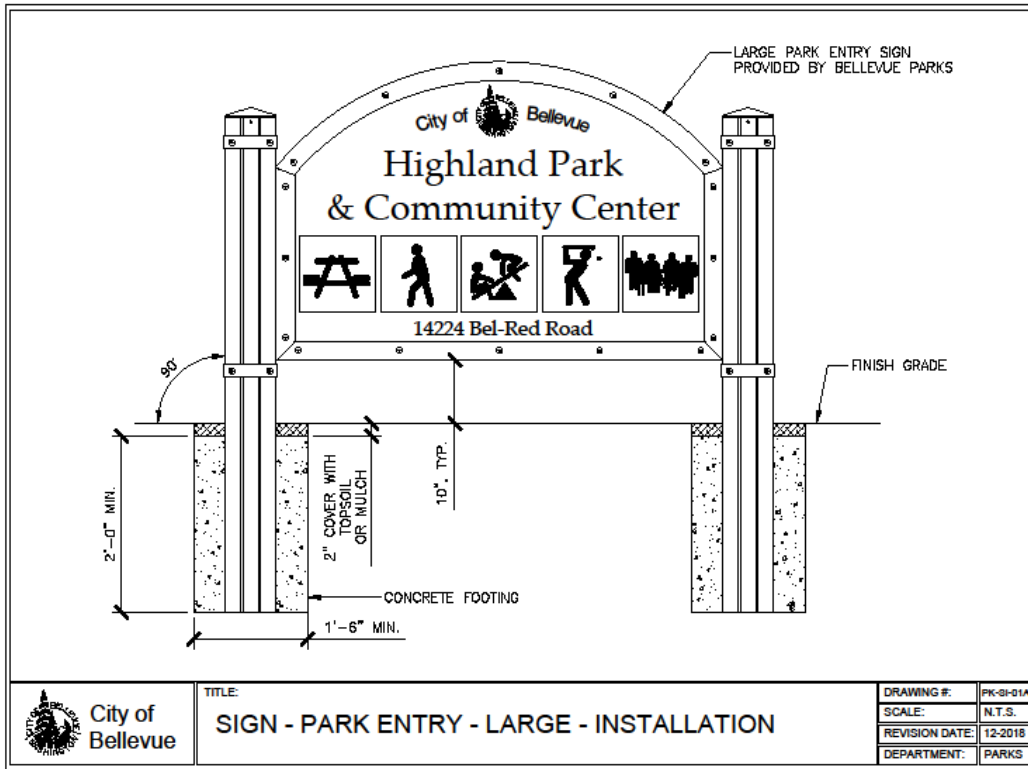

PICNIC AREA	RESTROOM	PLAYGROUND	TRAILS	FORMAL GARDEN	BOAT LAUNCH
BASEBALL/ SOFTBALL	BASKETBALL	SOCCER	TENNIS	WATER FEATURE	BIKE TRAILS
SWIMMING AREA	BOATING	FISHING	SKATE PARK	COMMUNITY CENTER	WILDLIFE
EXERCISE EQUIPMENT	A.D.A. ACCESSIBILITY	PHOTOGRAPHY	SITE SEEING	GOLF	BLUEBERRY FARM

NOTE: ANY SYMBOL NOT SHOWN SHALL BE REVIEWED AND APPROVED BY BELLEVUE PARKS BEFORE USE ON PARK ENTRY SIGNS.

	TITLE:	DRAWING #:	PK-SH-03
	<b>SIGN - PARK ENTRY - APPROVED SYMBOLS</b>	SCALE:	N.T.S.
		REVISION DATE:	12-2018
		DEPARTMENT:	PARKS

4"

2'-0"

2"

5/8"

1'-6" RADIUS, TYP.

1/8" FLAT SHEET ALUMINUM SIGN BACKING WITH WHITE LETTERING AND LOGOS, SEE NOTES 1 AND 3

-SANDWICH SIGN IN 3/8" GROOVE CUT DOWN THE CENTER OF THE POST

-SIGN FACING IDENTICAL ON BOTH SIDES, EXCEPT ARROW

-SECURE TO POST WITH (3) EACH 1/2"x5" GALV. CARRIAGE BOLTS, NUTS AND WASHERS, RECESSED 1/2", TYP.

Bellevue Youth Theatre

6x6 POST, SEE NOTE 2

(3) 1 1/4" DIA. HOLES DRILLED THROUGH POST PERPENDICULAR TO VEHICULAR TRAFFIC AT 6" INTERVALS

FINISH GRADE

UNDISTURBED NATIVE SOIL

1/2"x10" STEEL ROD THROUGH POST, TYP.

CONCRETE FOOTING

1'-4", TYP.

2'-7"

4 1/2"

5"

7'-0" MIN. 2" COVER, TYP.

3'-0"

2" TYP.

4" TYP.

NOTES:

- SIGN BACKING TO BE POWDER COATED TIGER "TURQUOISE BLUE" #RAL-5018 OR APPROVED EQUAL AND SHALL RECEIVE NON-REFLECTIVE ANTI-GRAFFITI LAMINATE.
- POST TO BE PRESSURE TREATED D.F. #2 OR BETTER AND PAINTED 2 COATS "CAPE COD GRAY" OR EQUAL.
- ALL LETTERING AND GRAPHICS TO BE "WHITE", MACHINE-CUT, NON-REFLECTIVE VINYL (3-M SCOTCHCAL #3470 OR EQUAL). "CITY OF BELLEVUE" LETTER STYLE TO BE 1 1/2" HIGH CAPS SWISS 721 BT, CURVED TO 2'-3" RADIUS (TYP.). ALL OTHER LETTERING TO BE PALATINO AND SIZED AS NECESSARY (NO SMALLER THAN 2", TYP.)
- TEXT SHOWN IS FOR REFERENCE ONLY. FINAL TEXT TO BE DETERMINED BY BELLEVUE PARKS. SUBMIT SIGN PROOF FOR FINAL APPROVAL PRIOR TO FABRICATION.

	TITLE:	DRAWING #:	PK-SH-04
	<b>SIGN - WAYFINDING HATCHET</b>	SCALE:	N.T.S.
		REVISION DATE:	12-2018
		DEPARTMENT:	PARKS

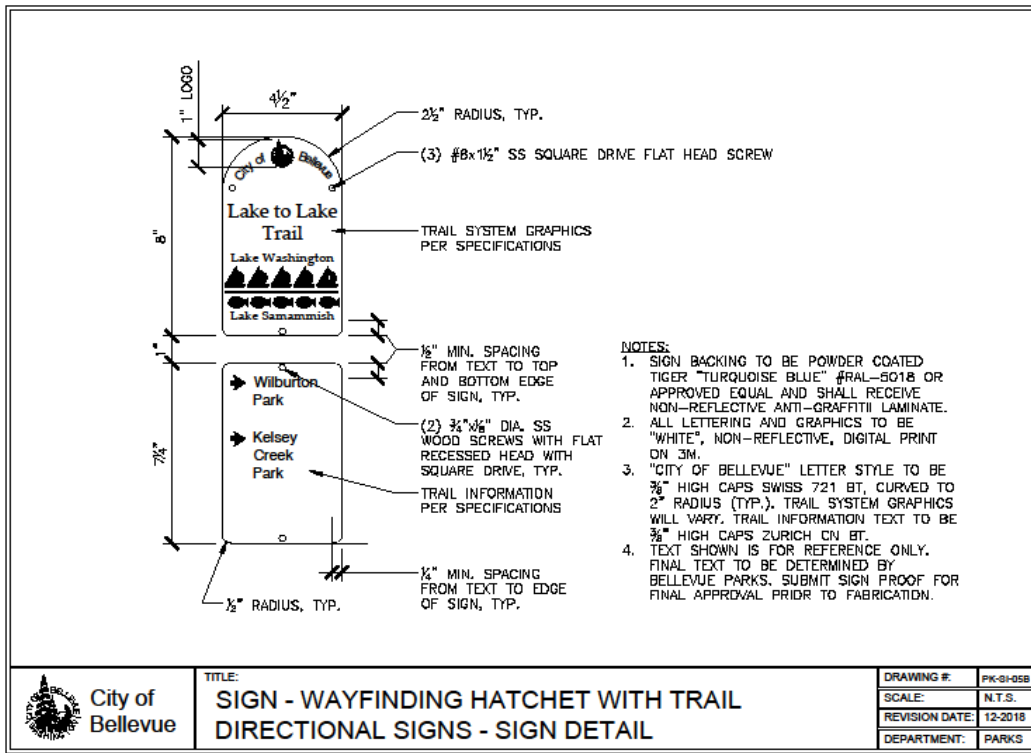
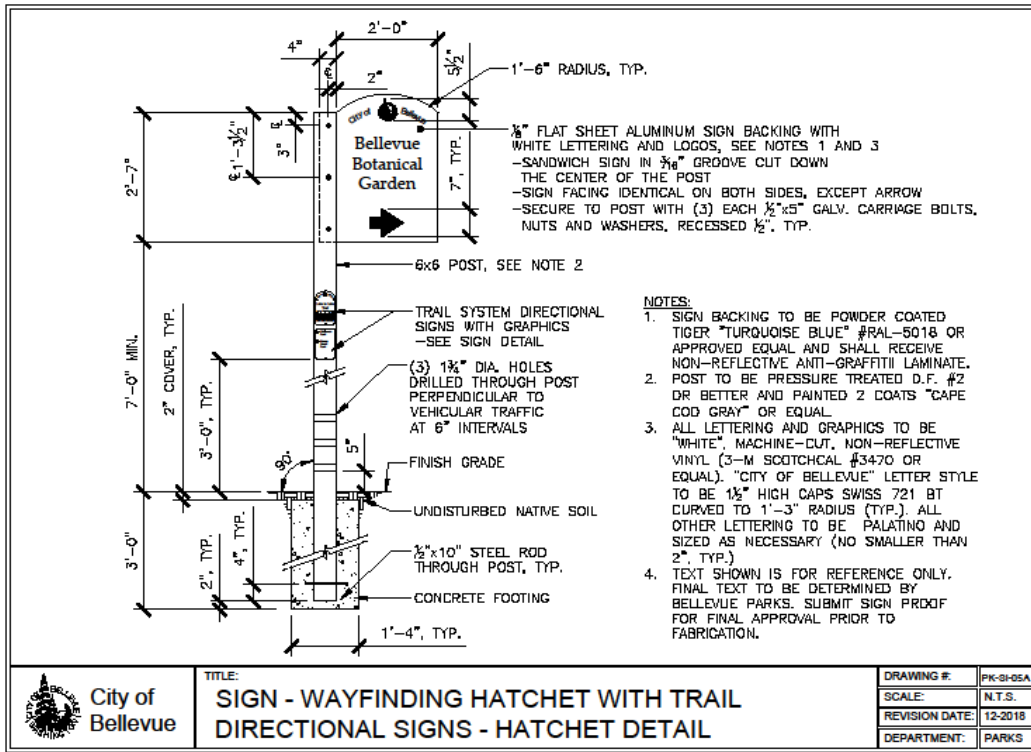

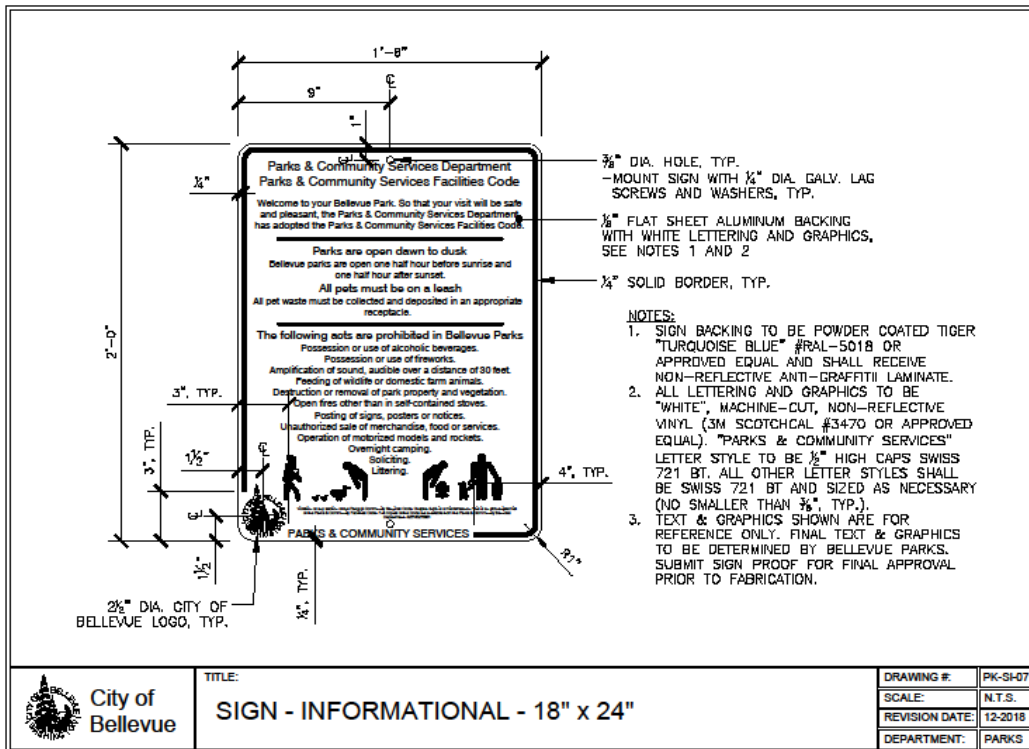
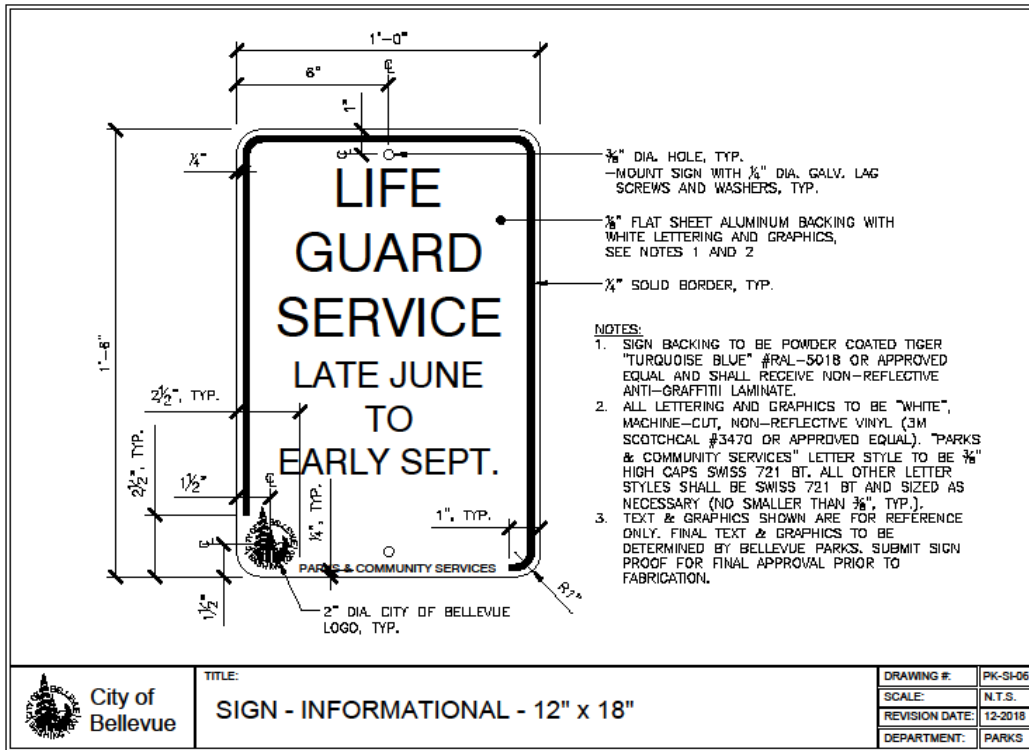

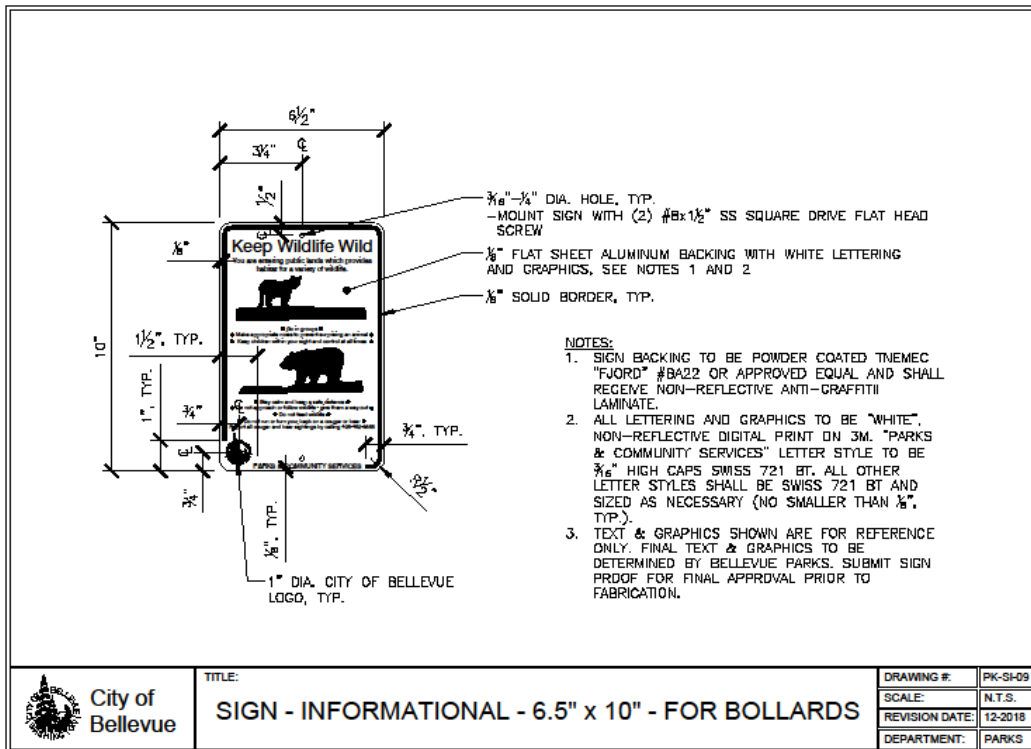
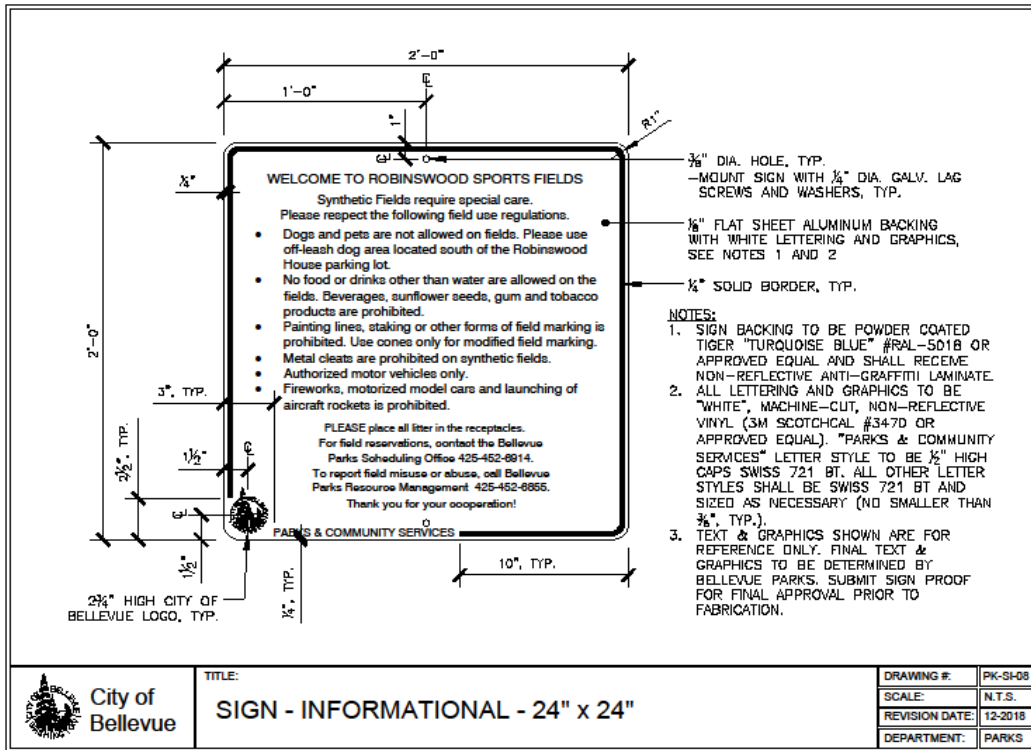

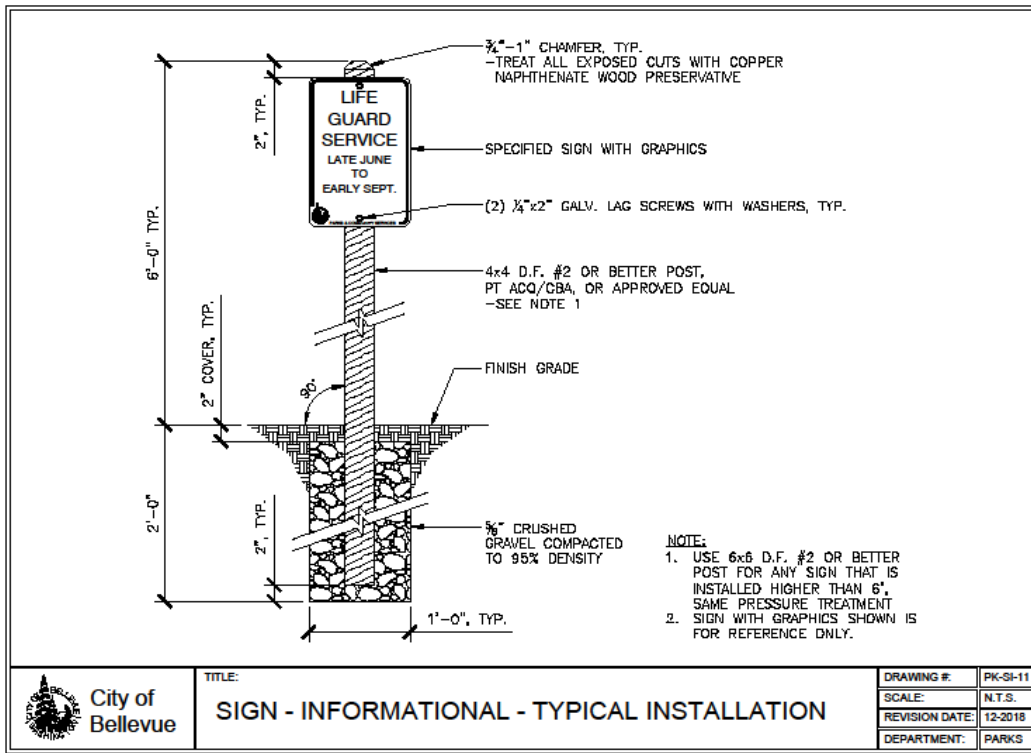
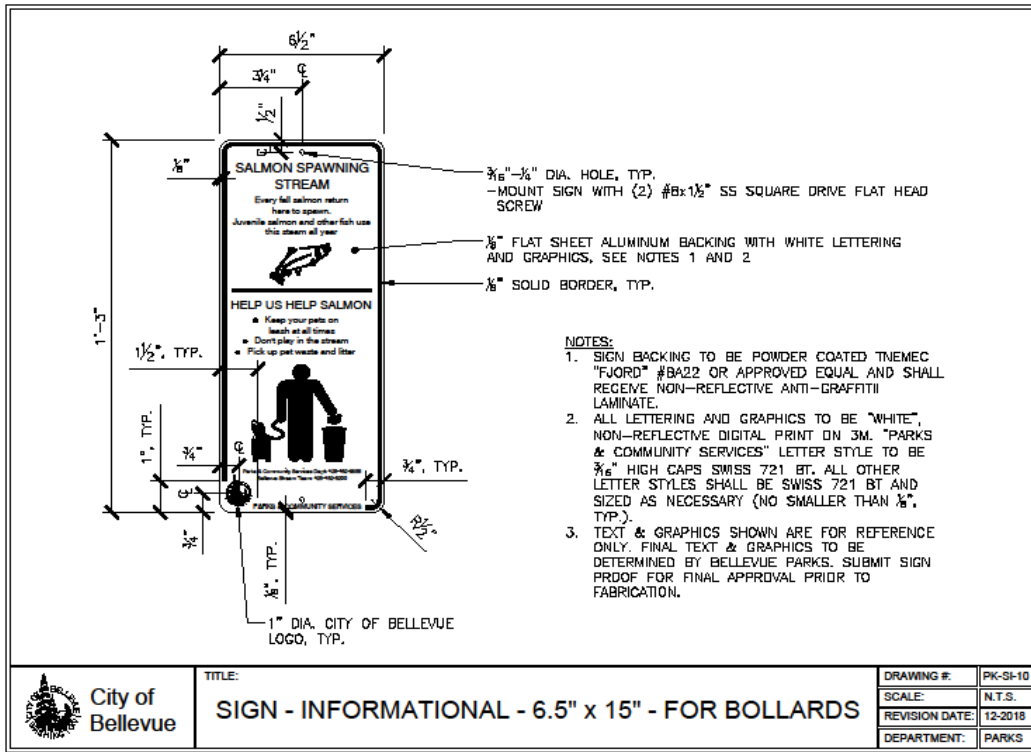



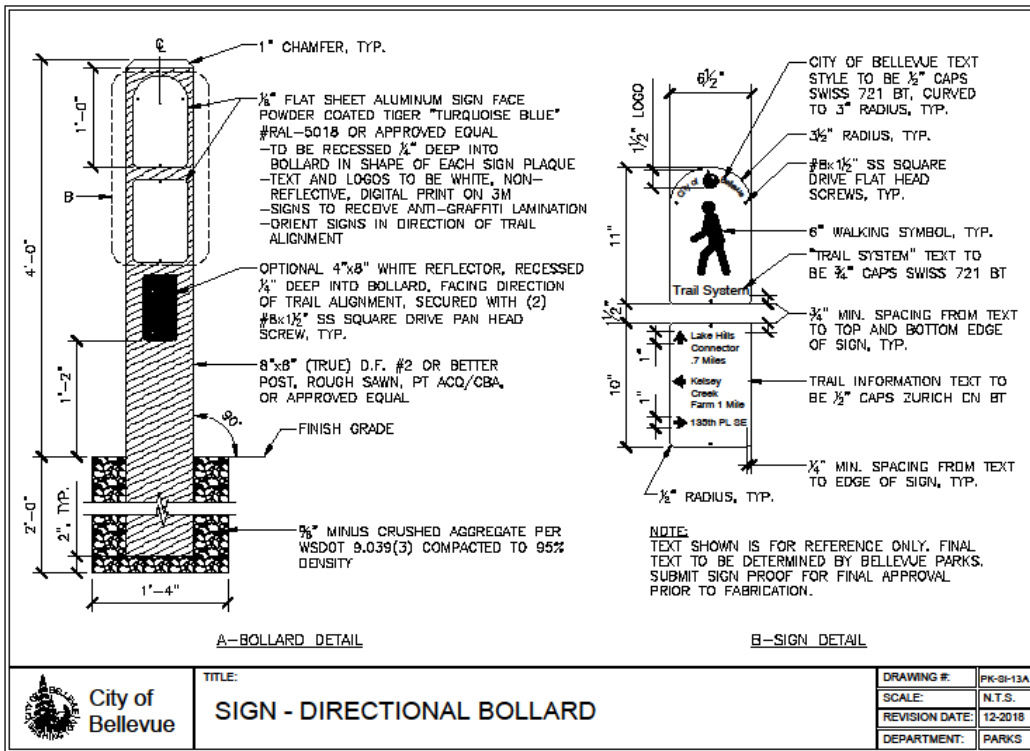
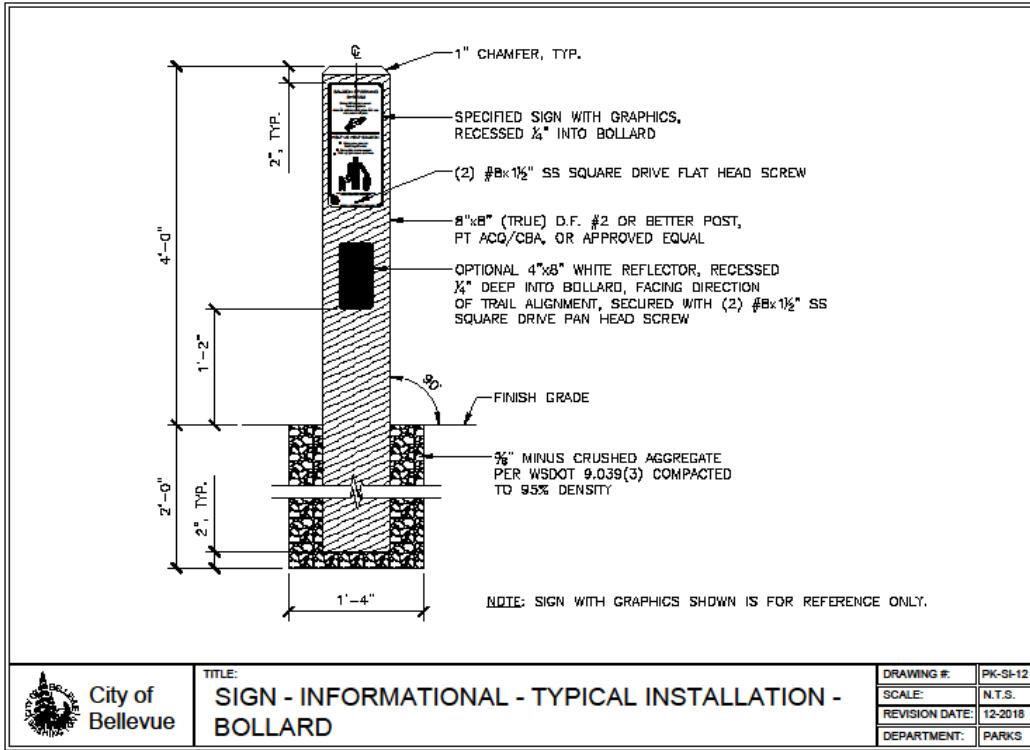

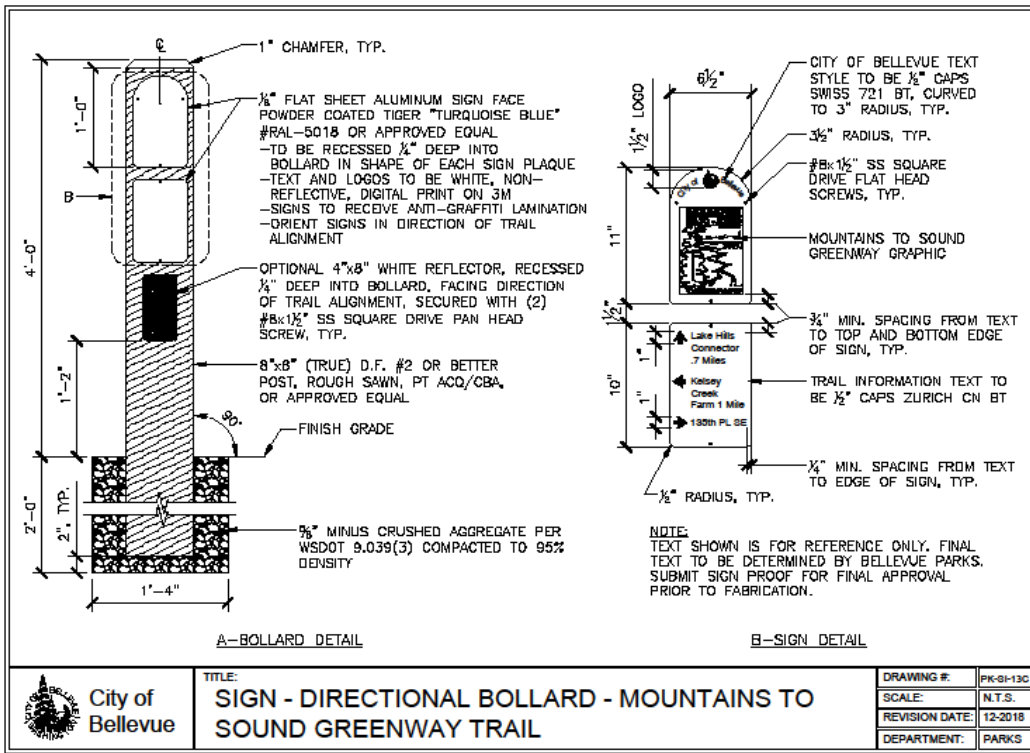
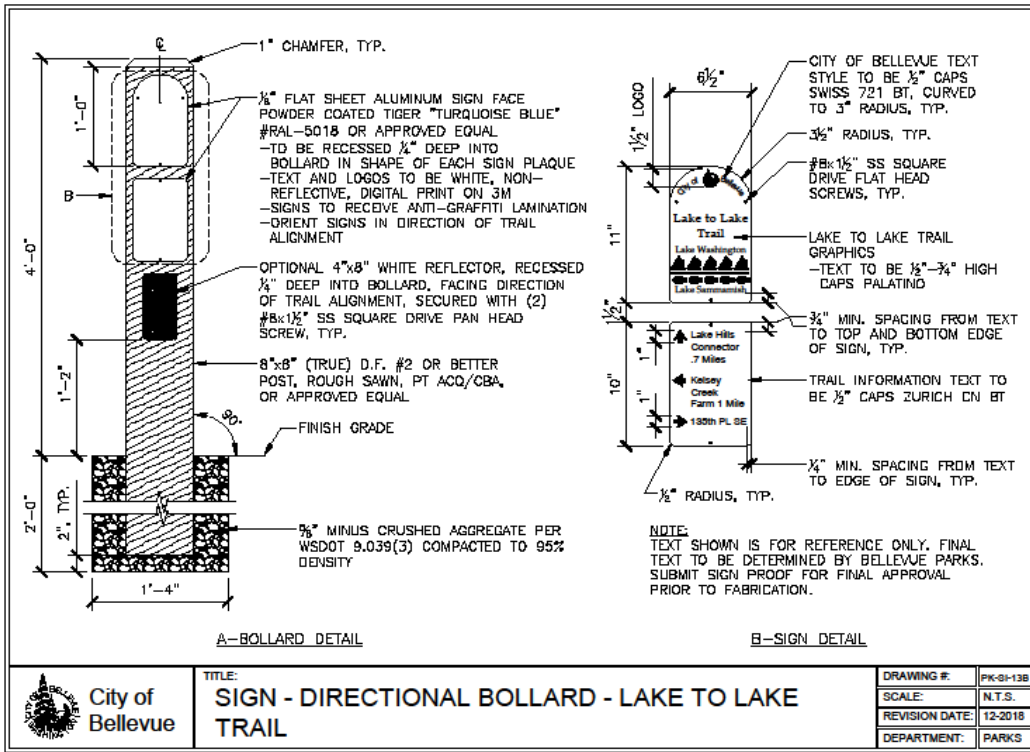

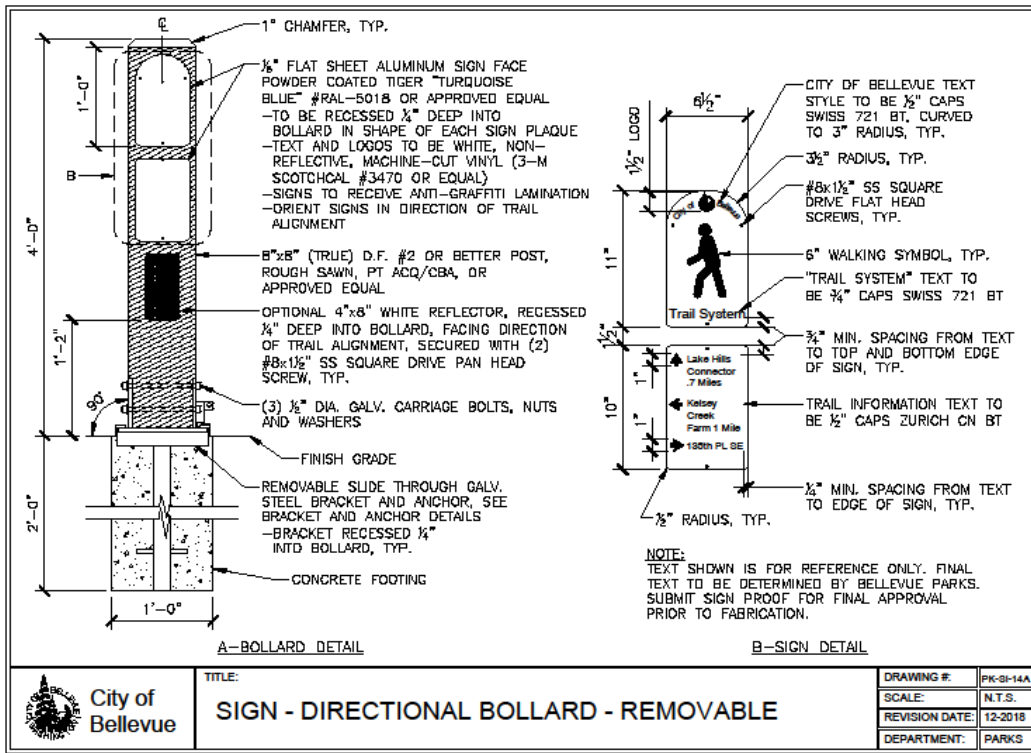
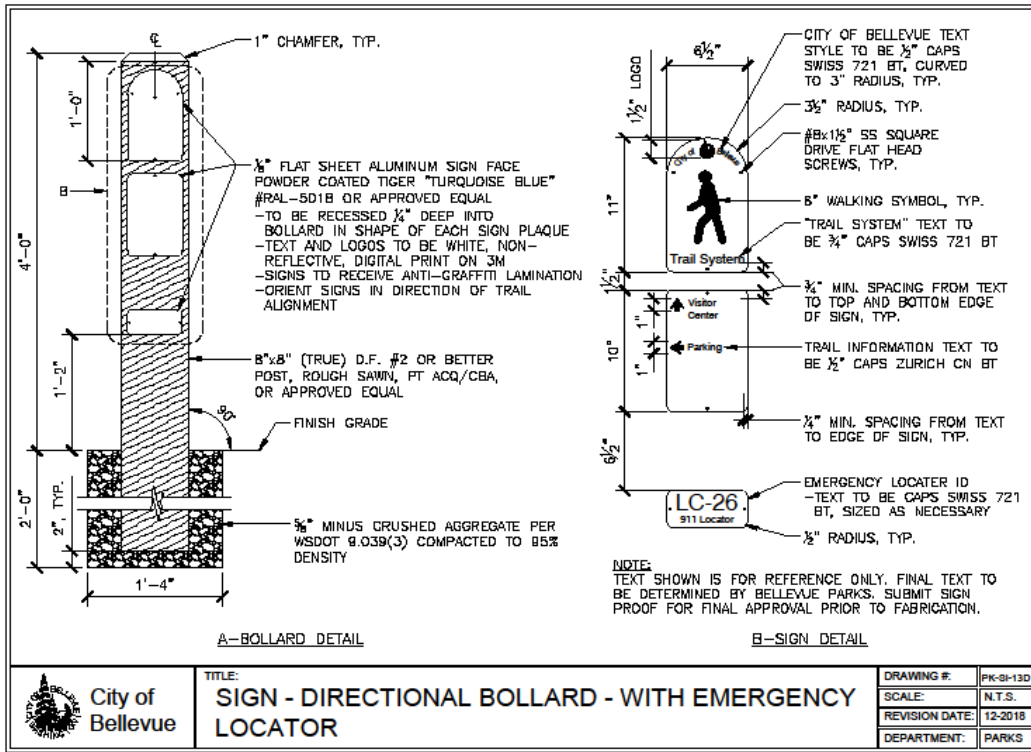

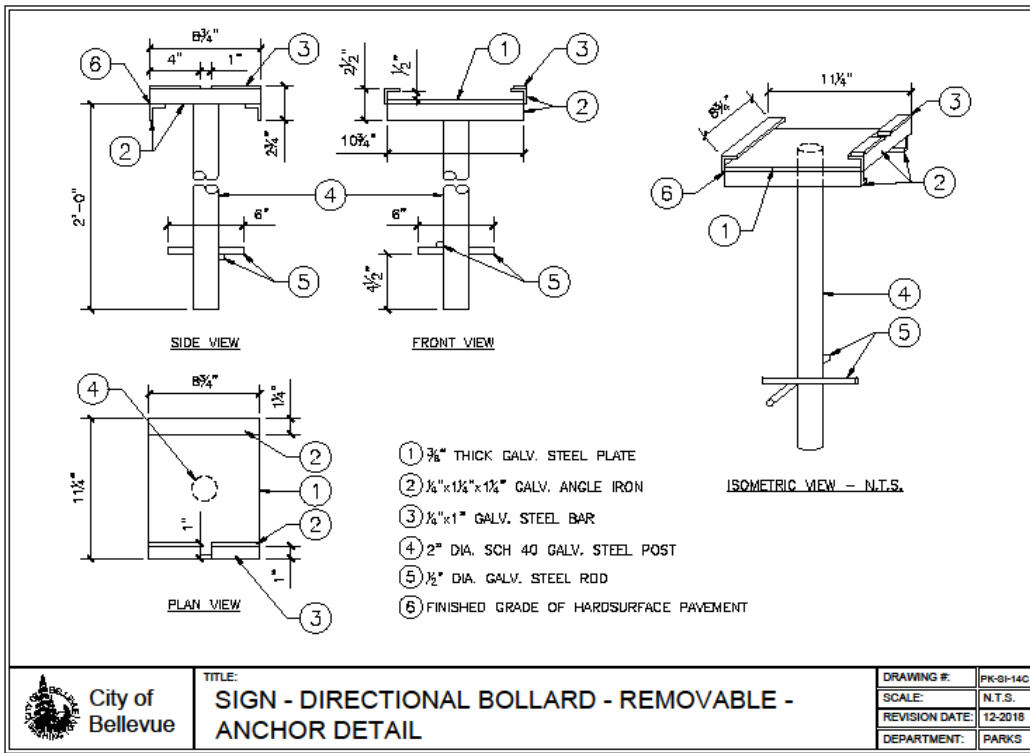
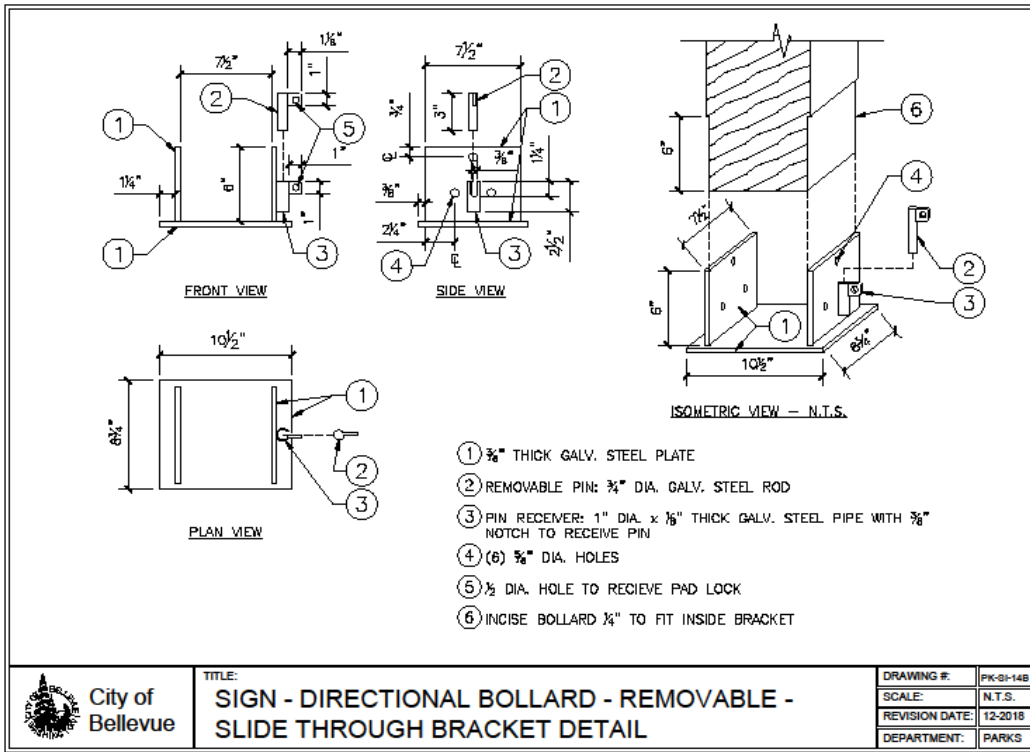

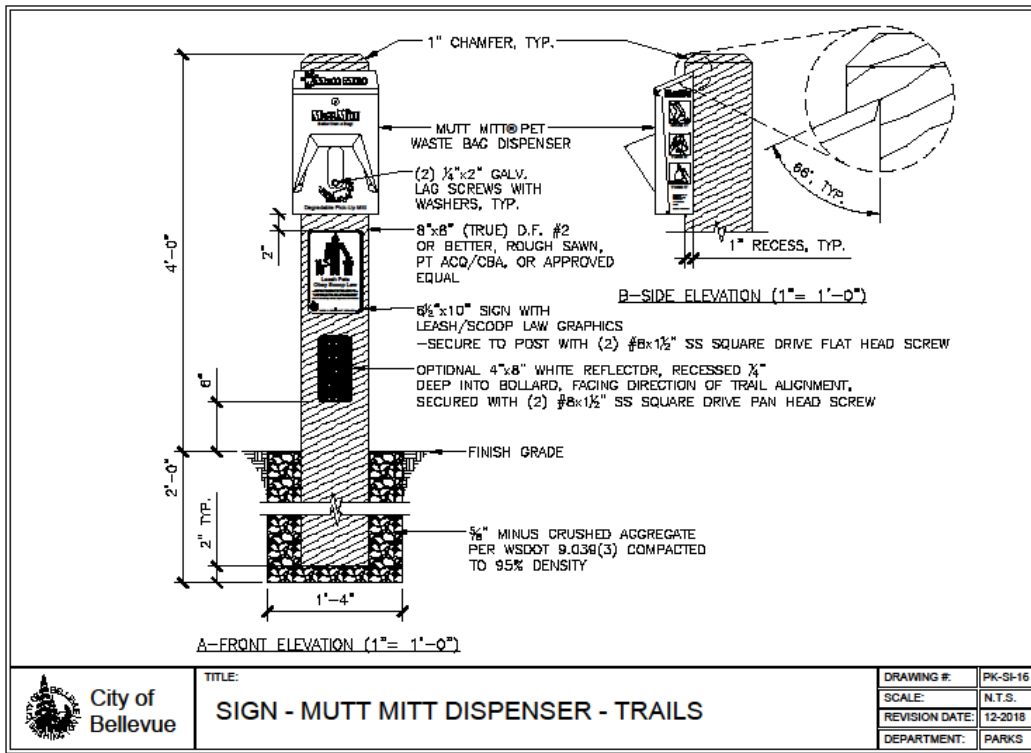
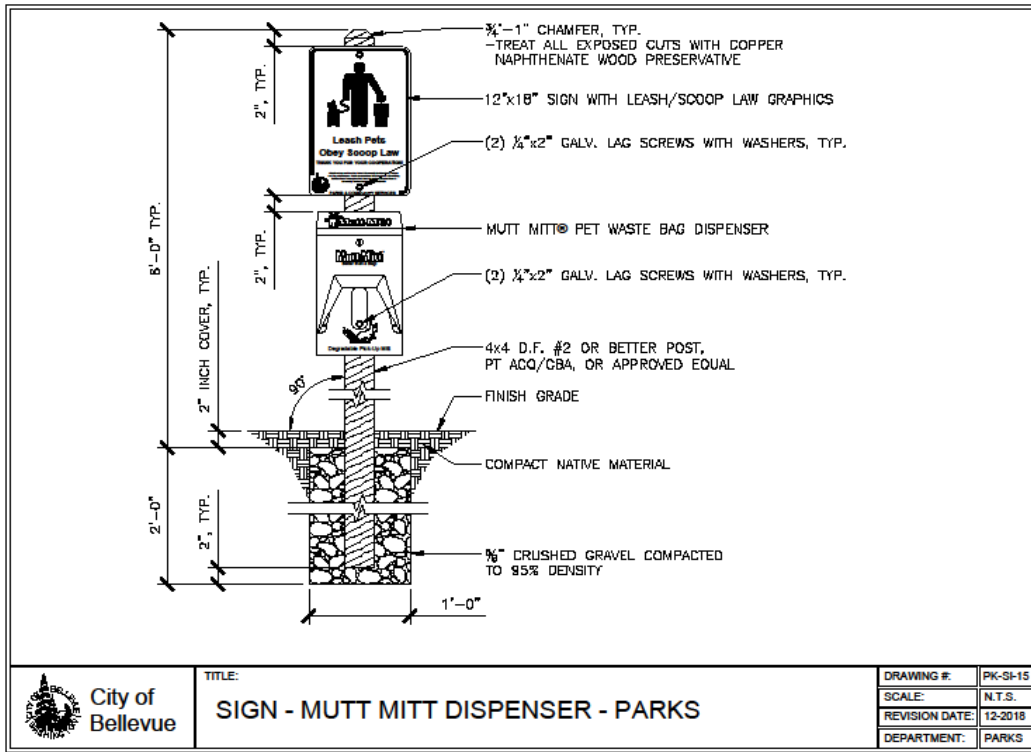

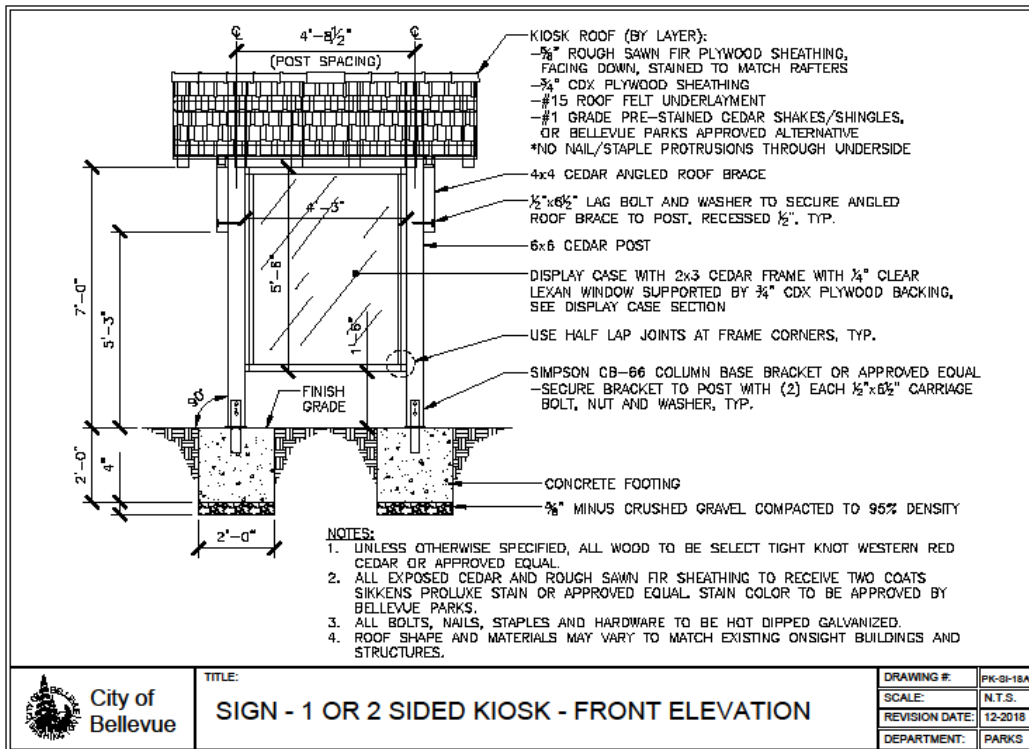
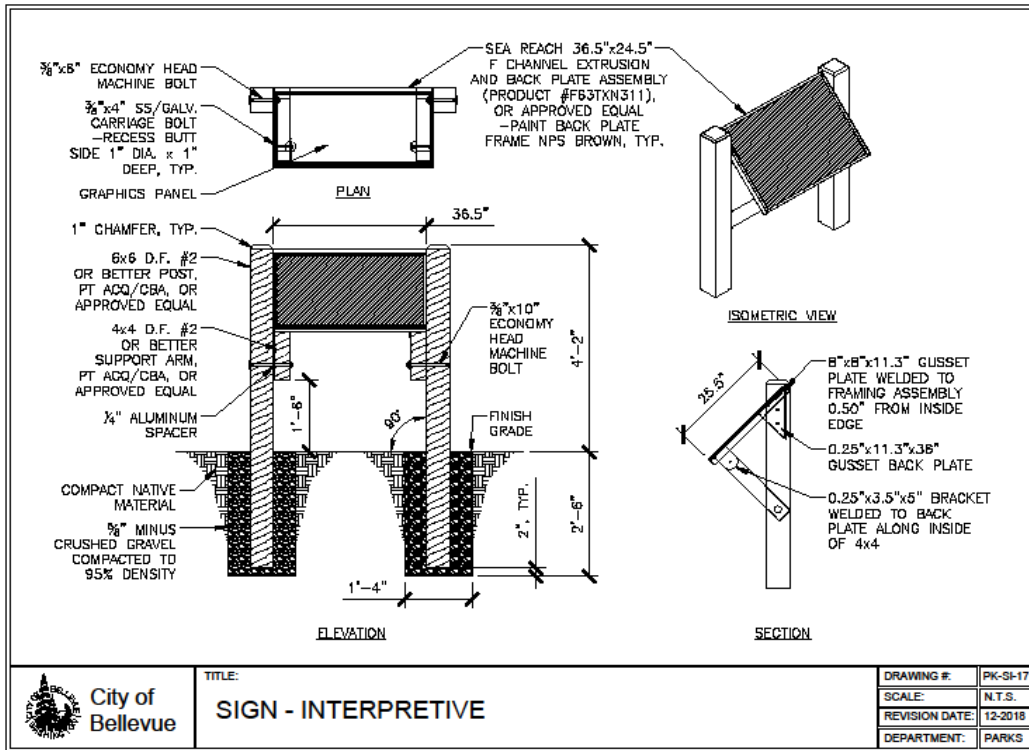

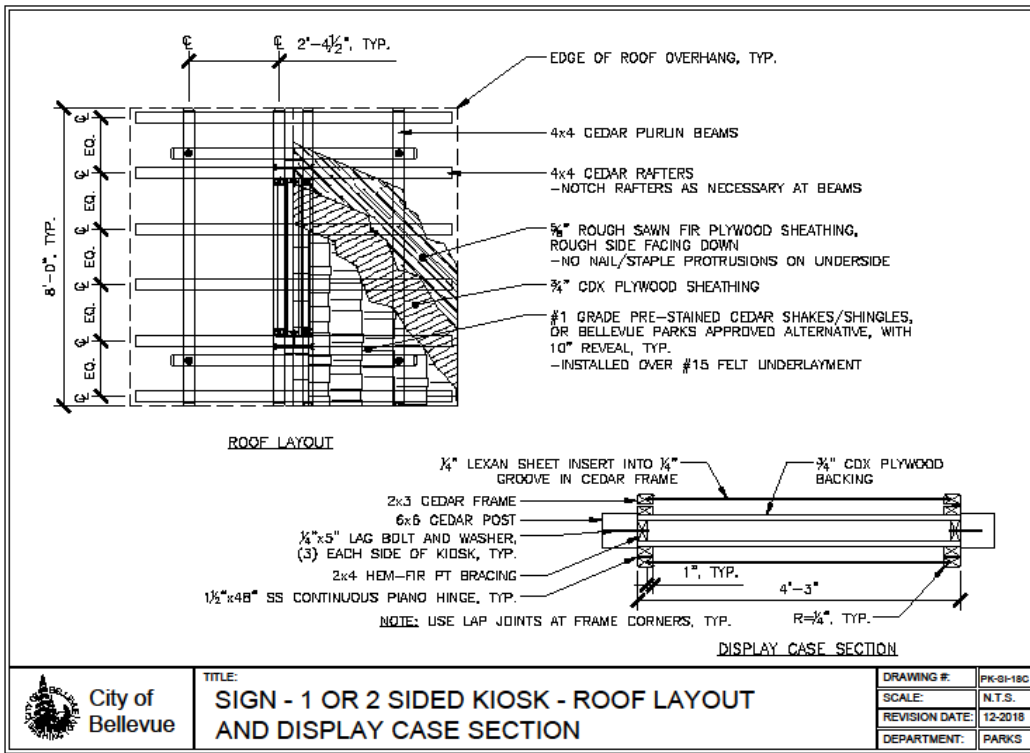
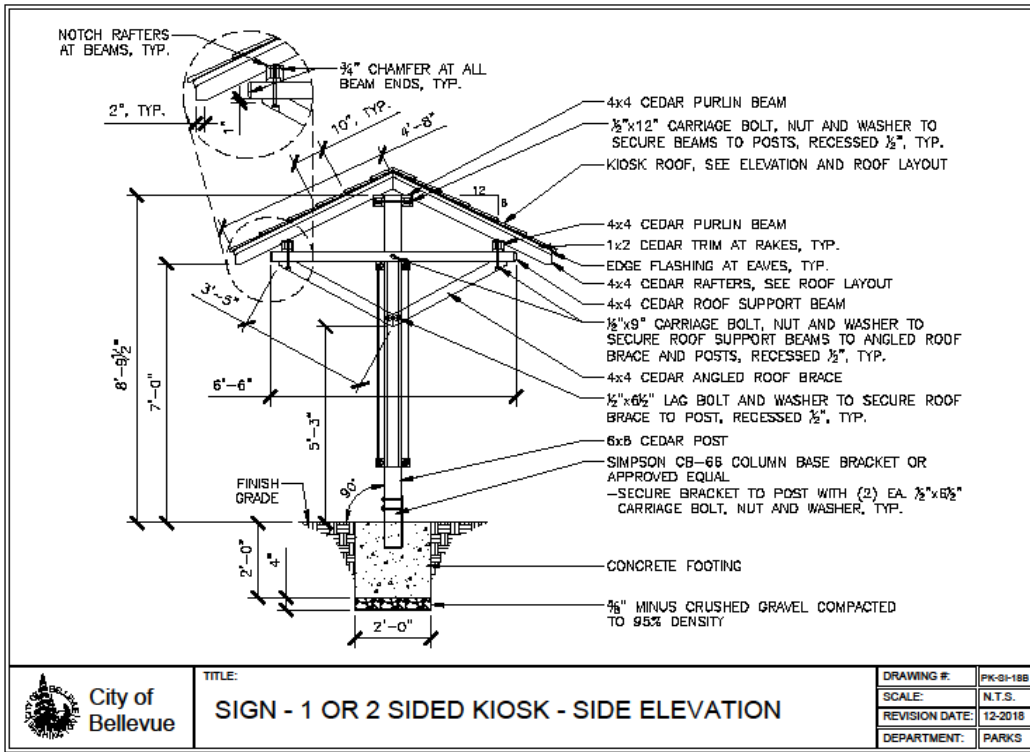

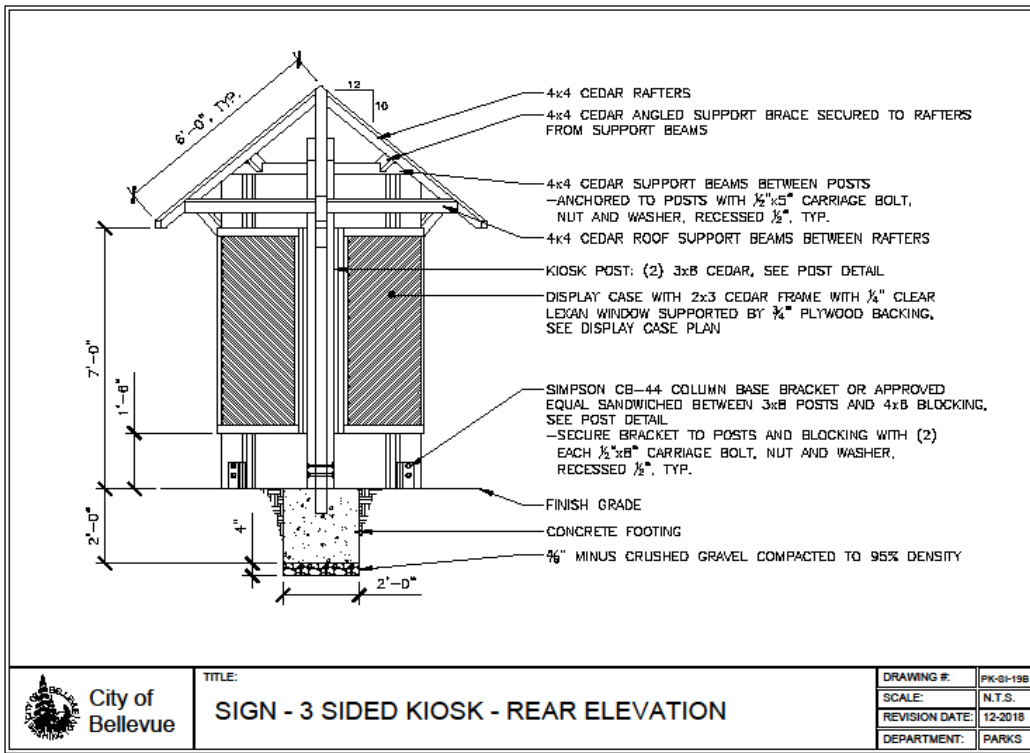
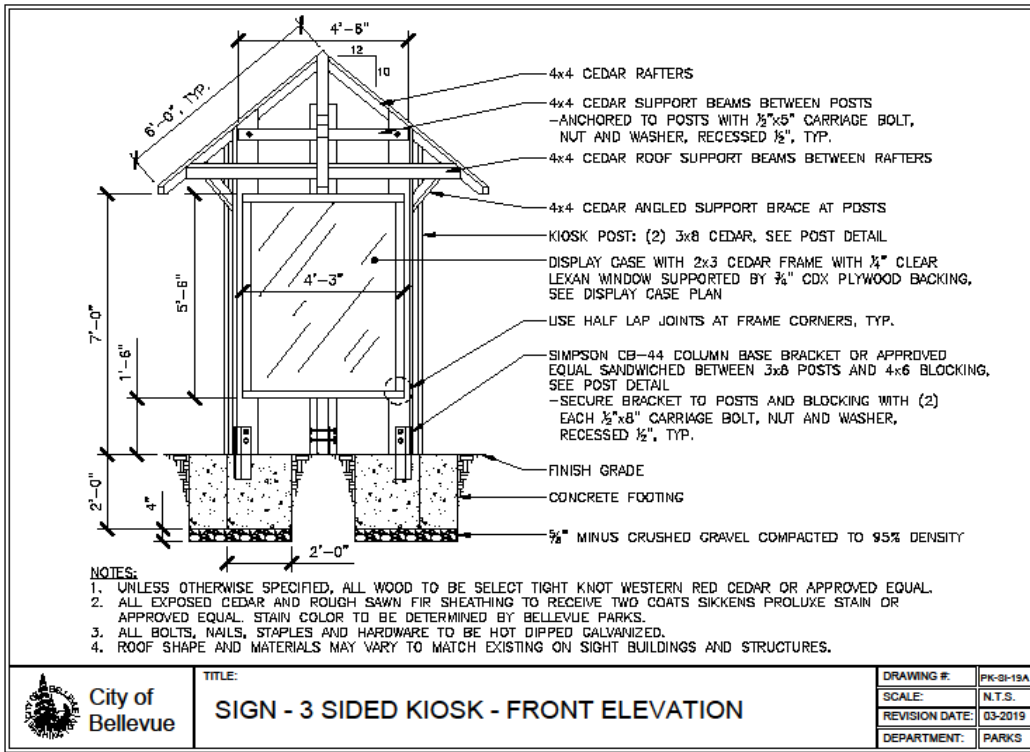



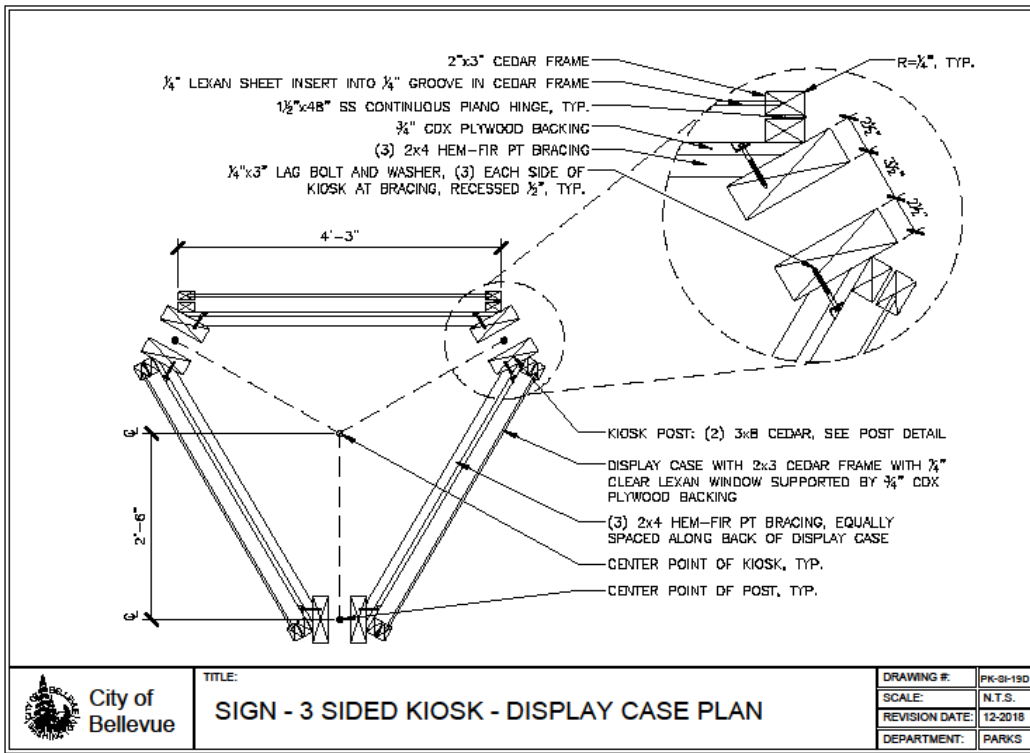
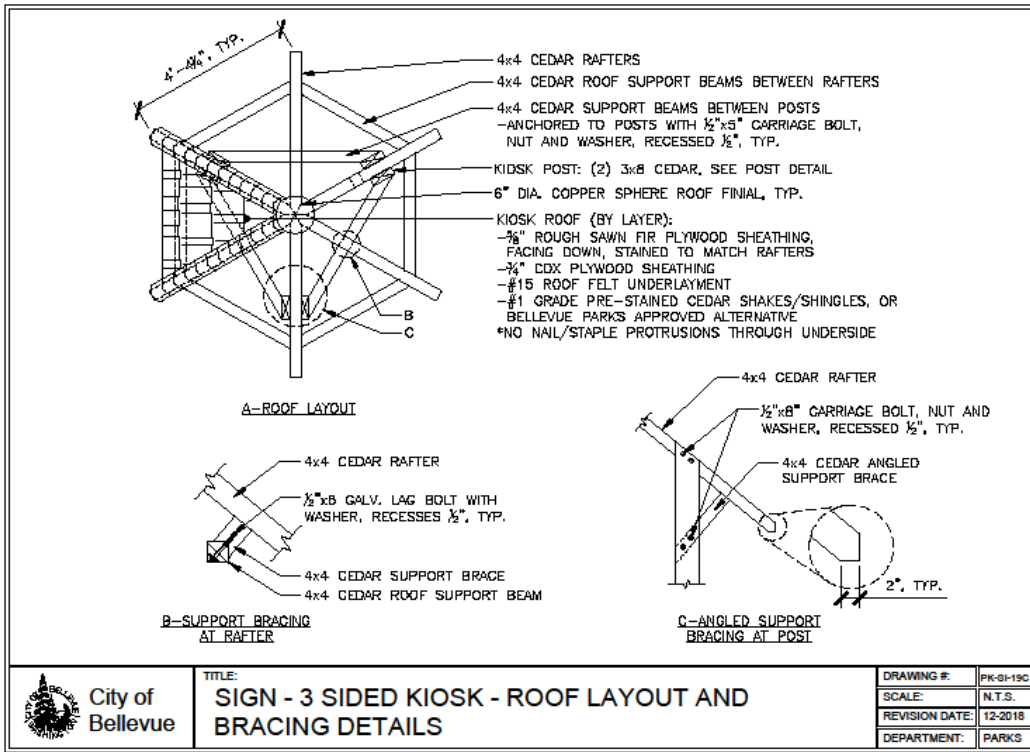

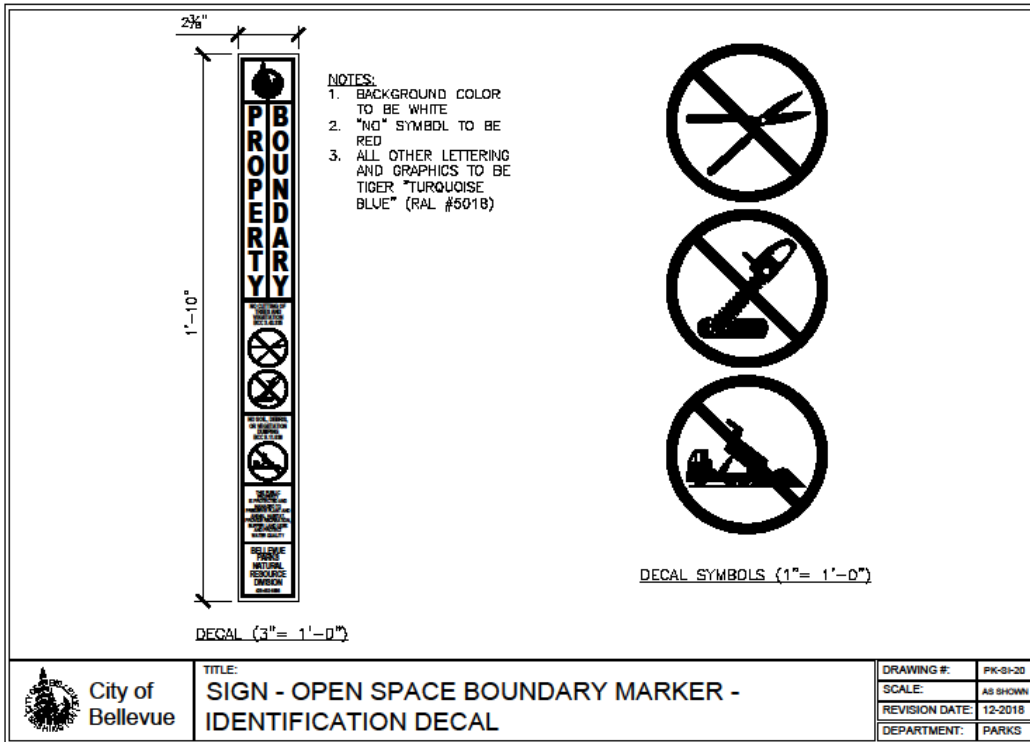
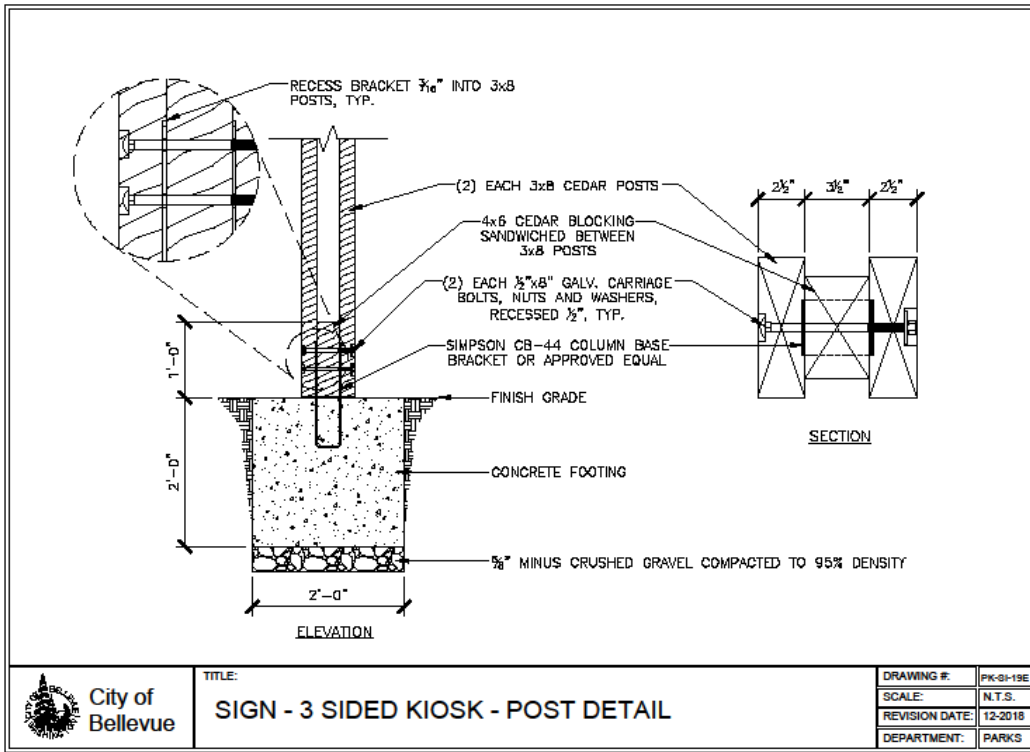

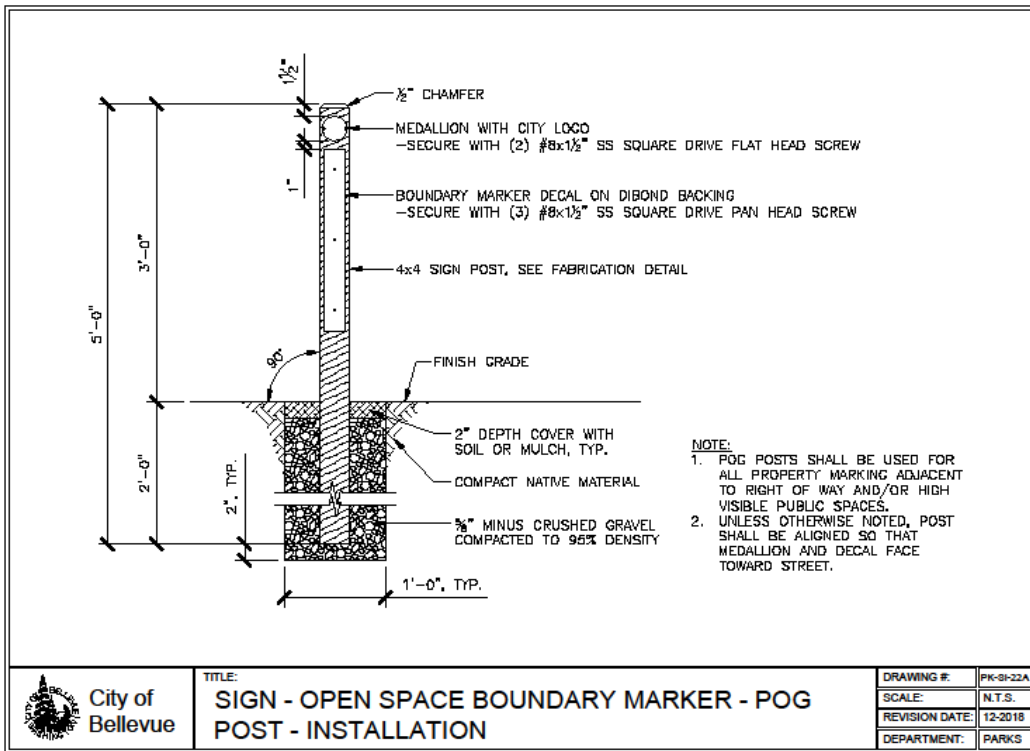
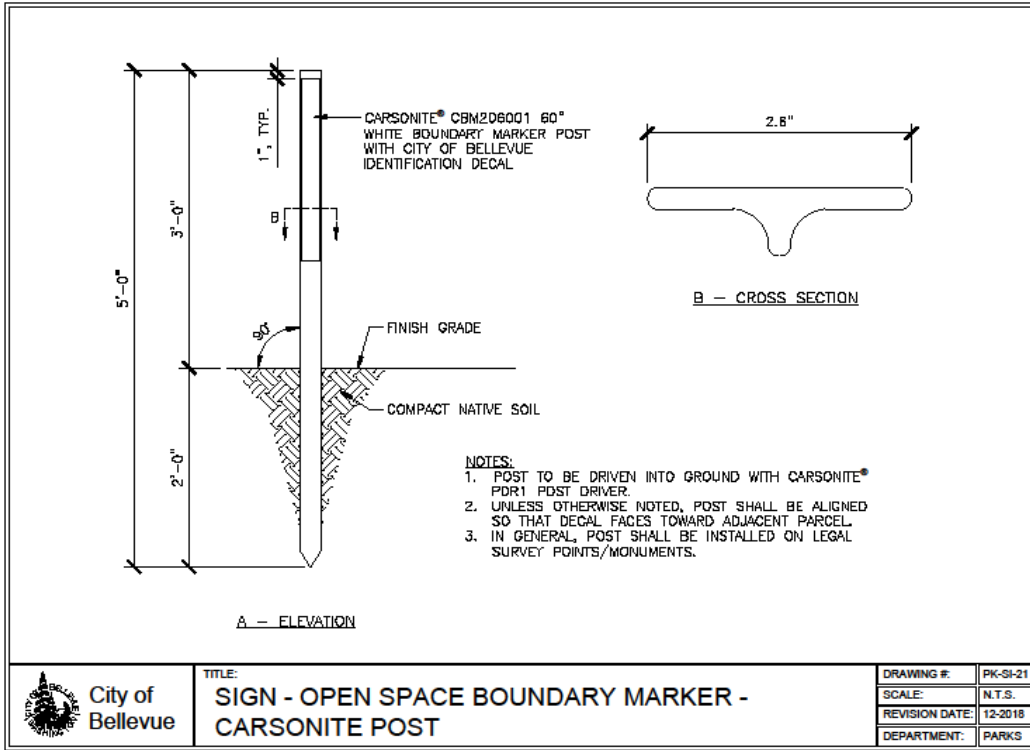

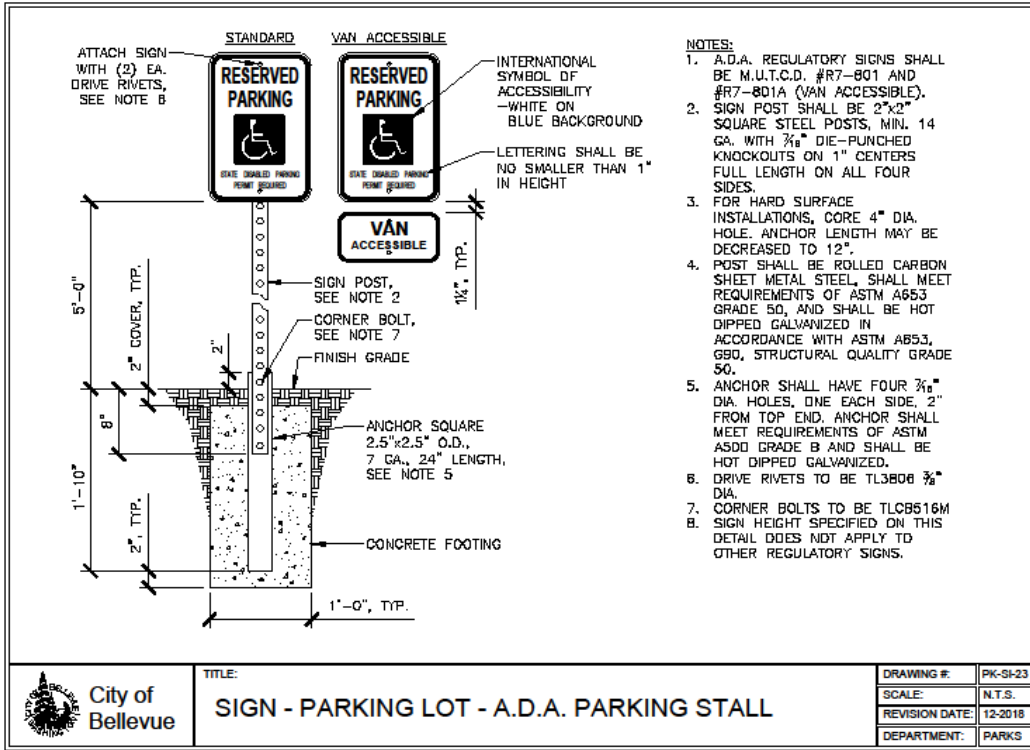
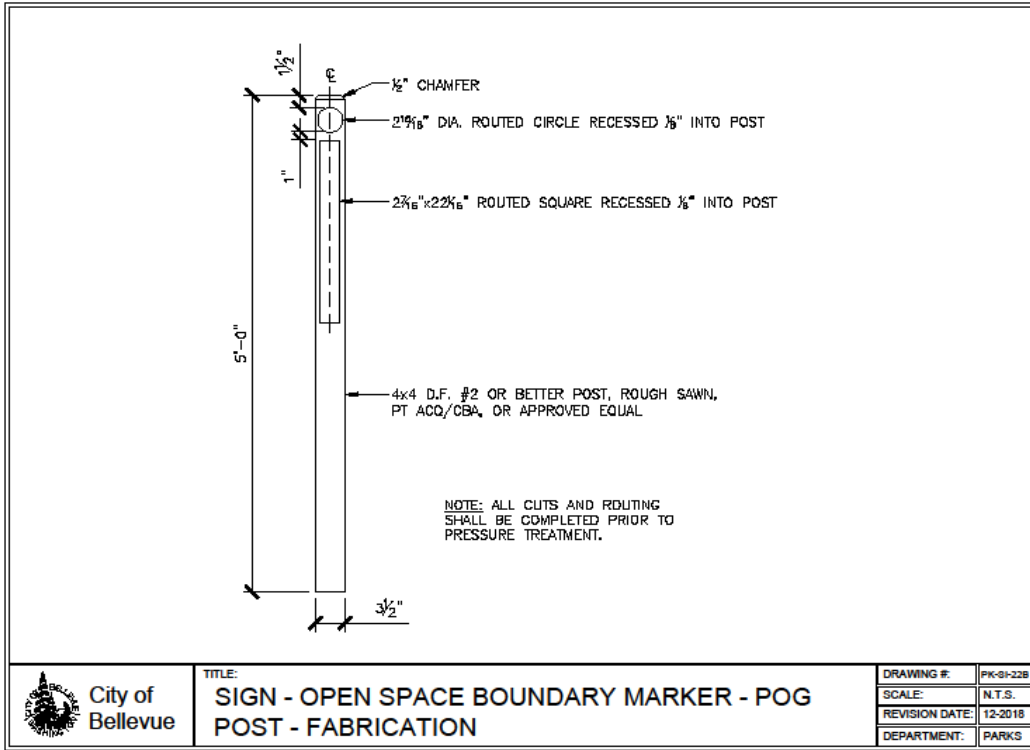

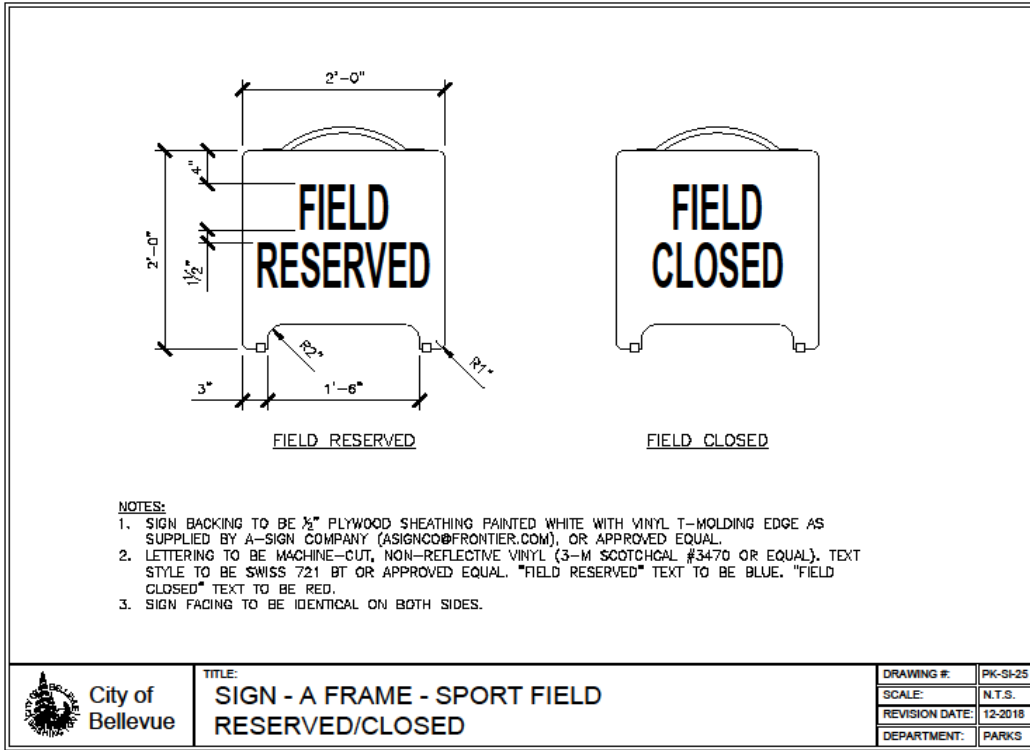
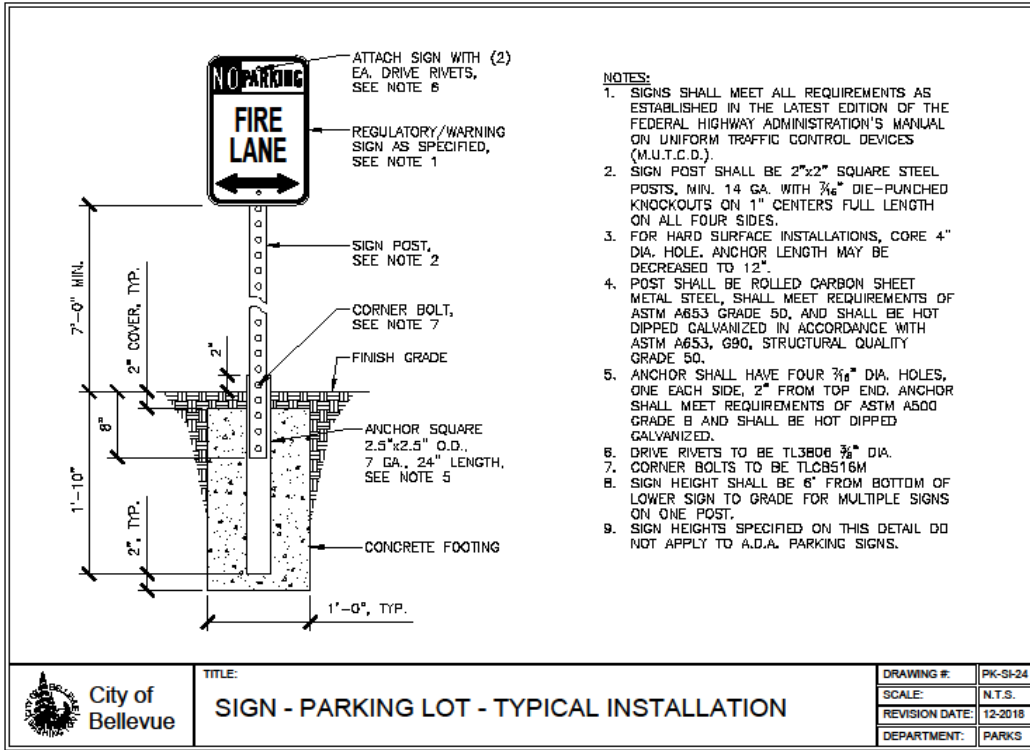

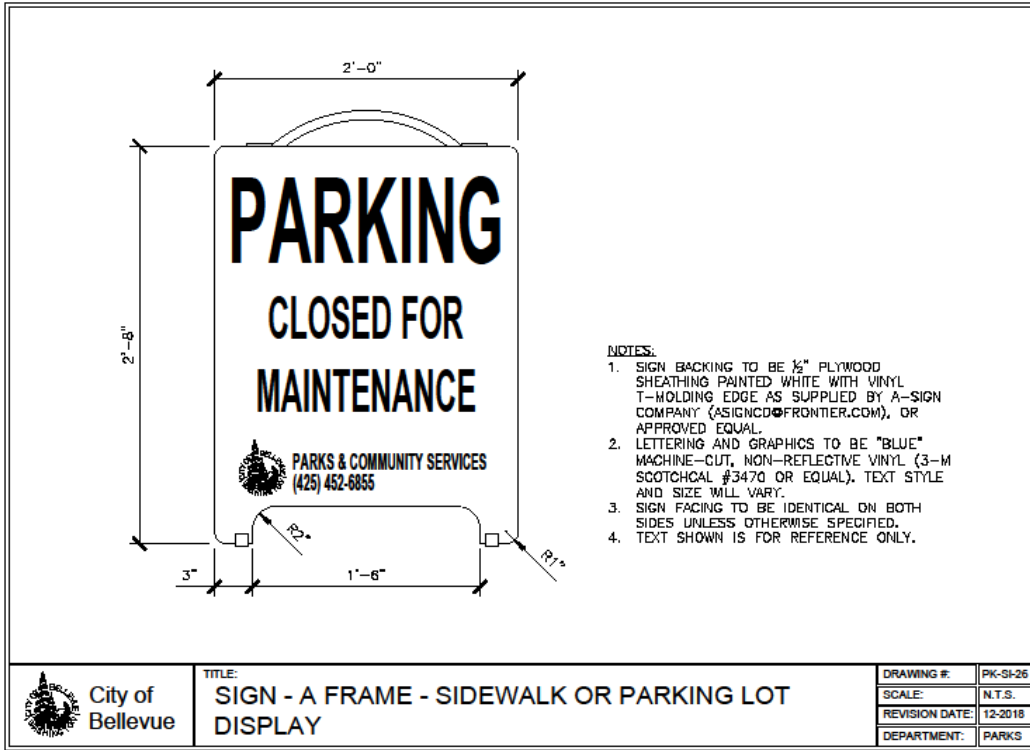

City of Bellevue

TITLE:

SIGN - A FRAME - SIDEWALK OR PARKING LOT DISPLAY

DRAWING #:

PK-SI-25

SCALE:

N.T.S.

REVISION DATE:

12-2018

DEPARTMENT:

PARKS

(This page intentionally left blank)

# Fencing

---





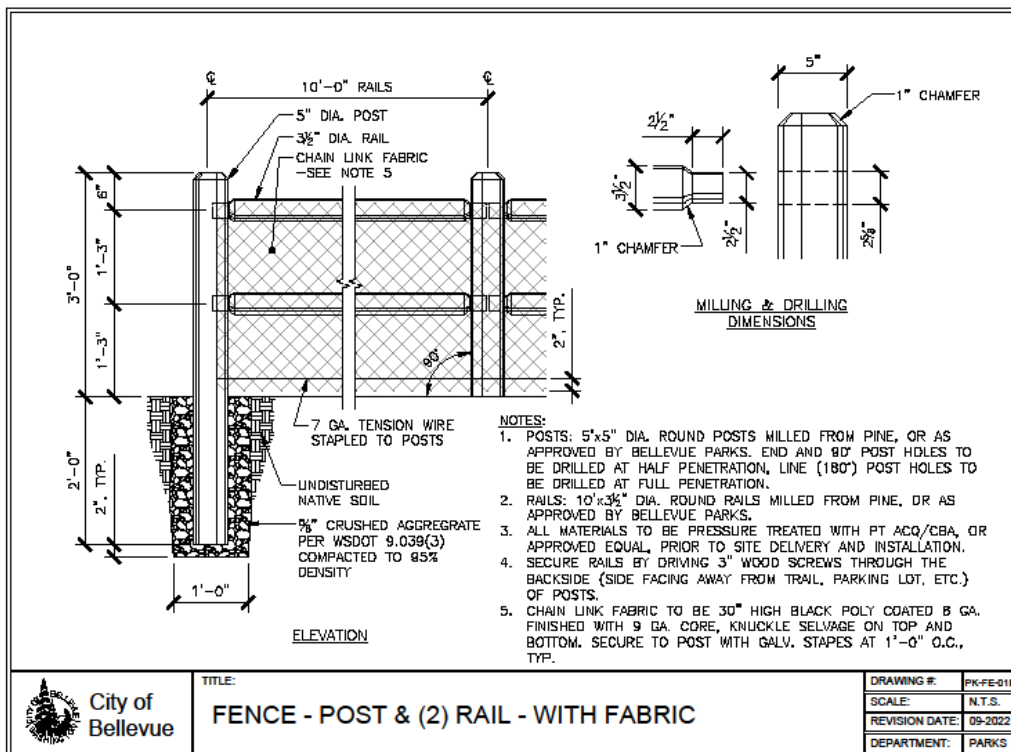
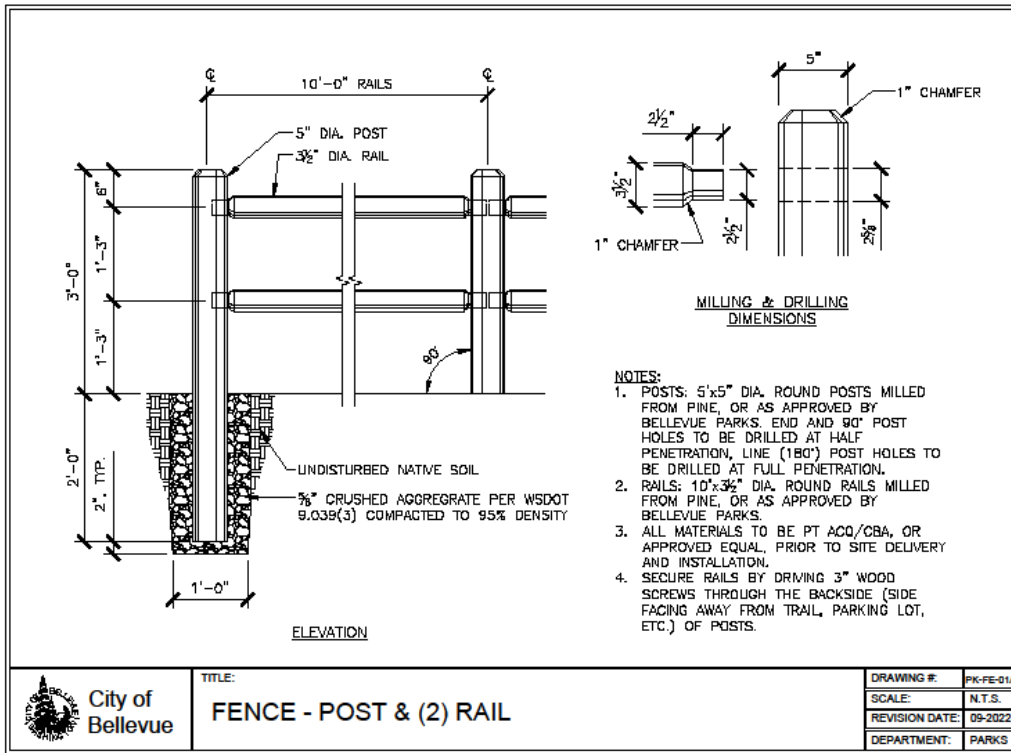

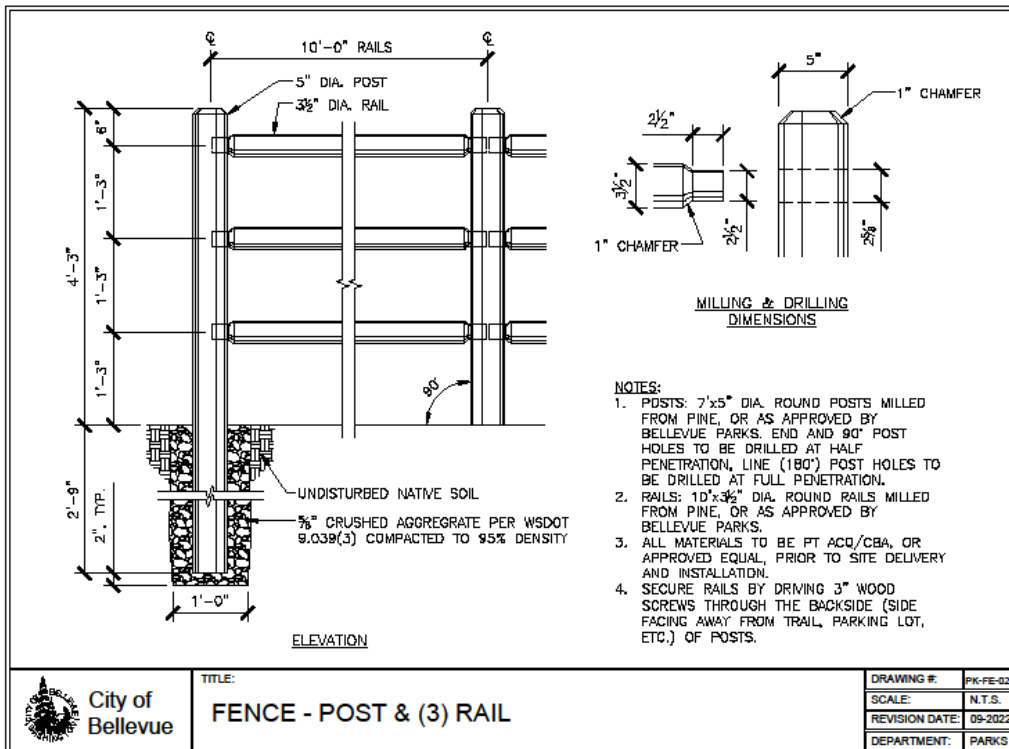
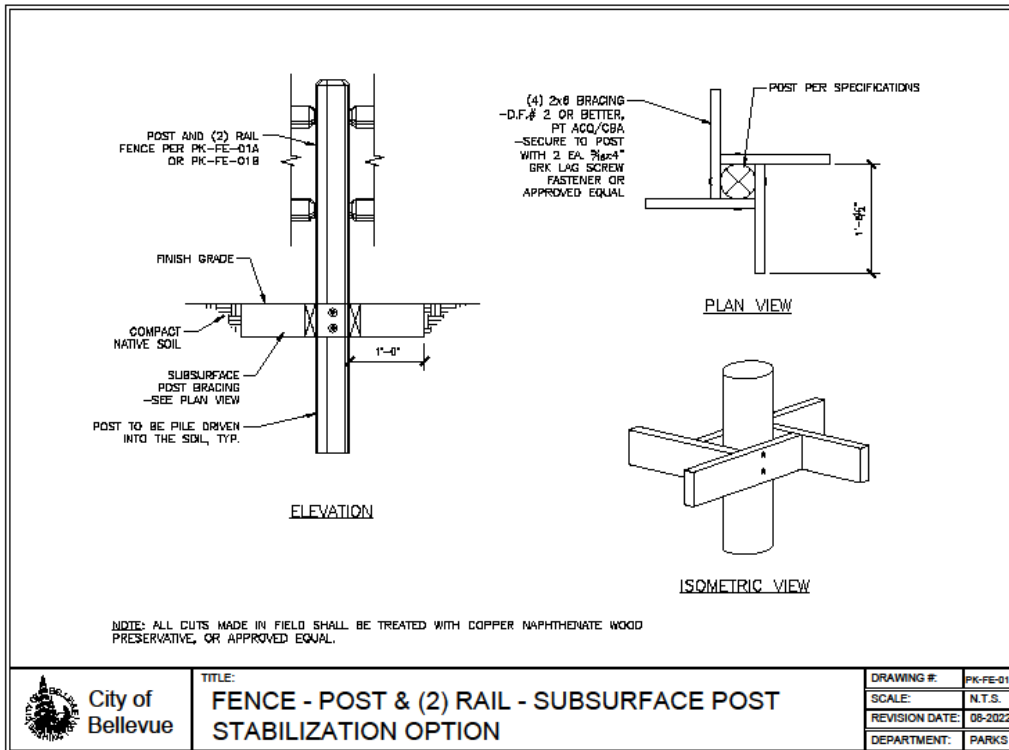

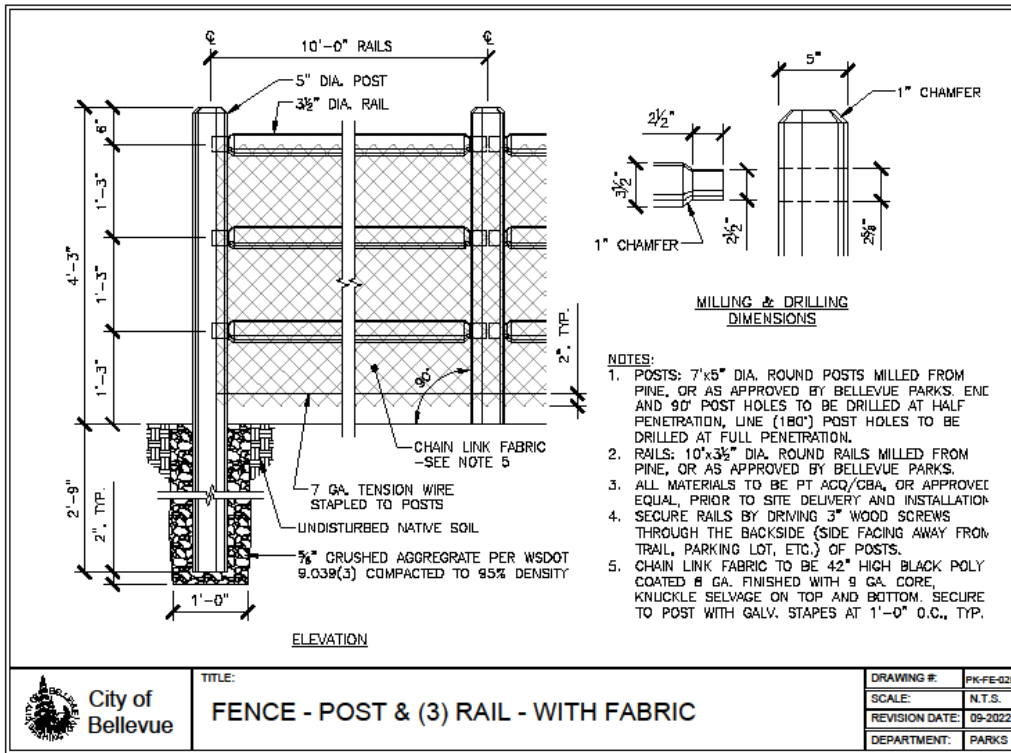

City of Bellevue

TITLE:

FENCE - POST & (3) RAIL - WITH FABRIC

DRAWING #:	PK-FE-02B
SCALE:	N.T.S.
REVISION DATE:	09-2022
DEPARTMENT:	PARKS

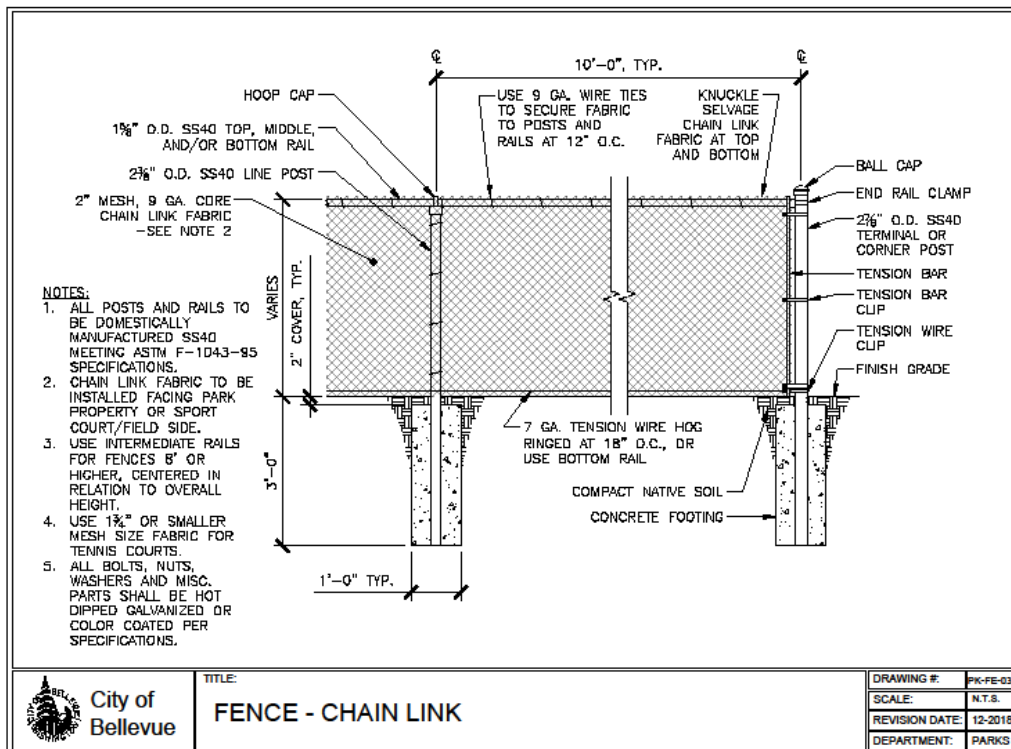

City of Bellevue

TITLE:

FENCE - CHAIN LINK

DRAWING #:	PK-FE-03A
SCALE:	N.T.S.
REVISION DATE:	12-2018
DEPARTMENT:	PARKS

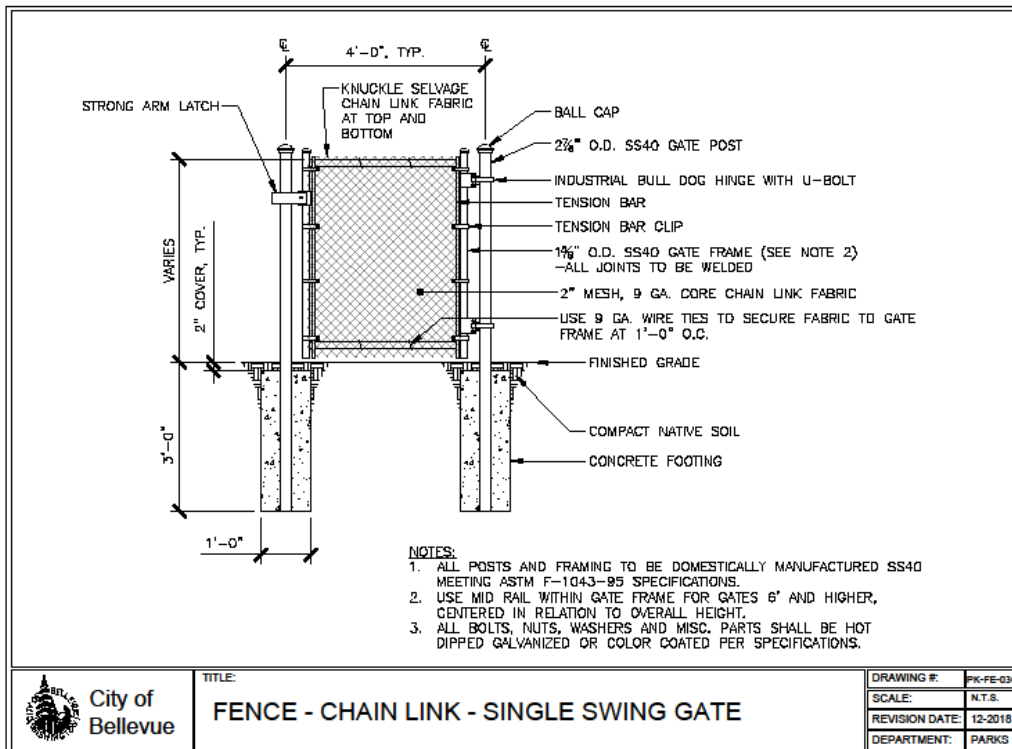
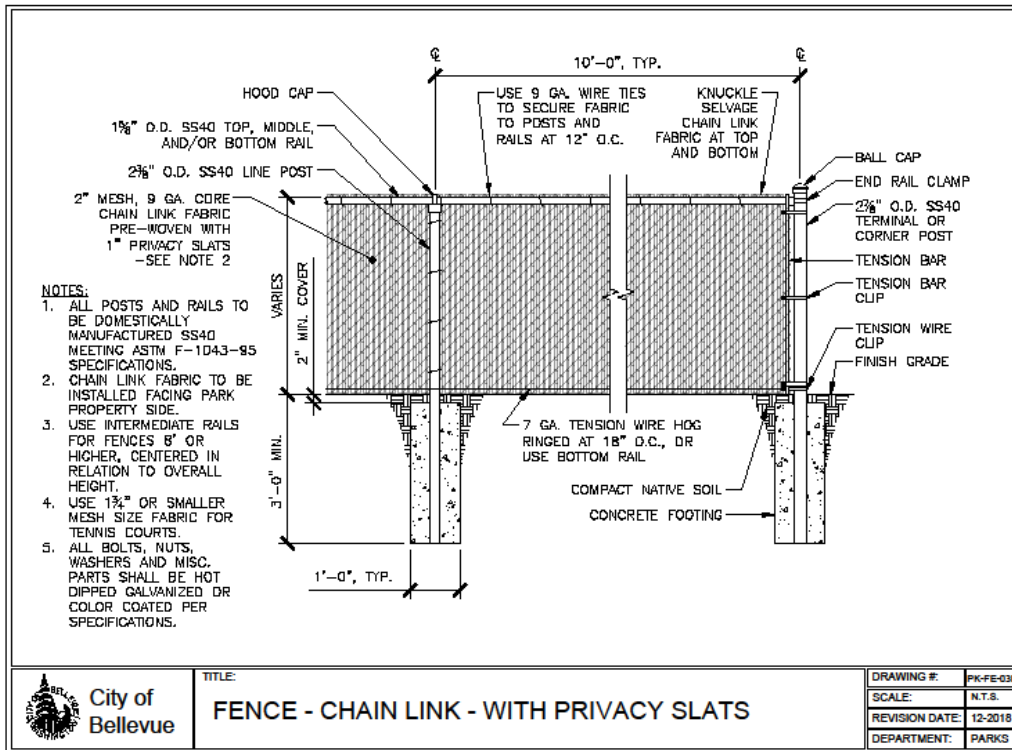

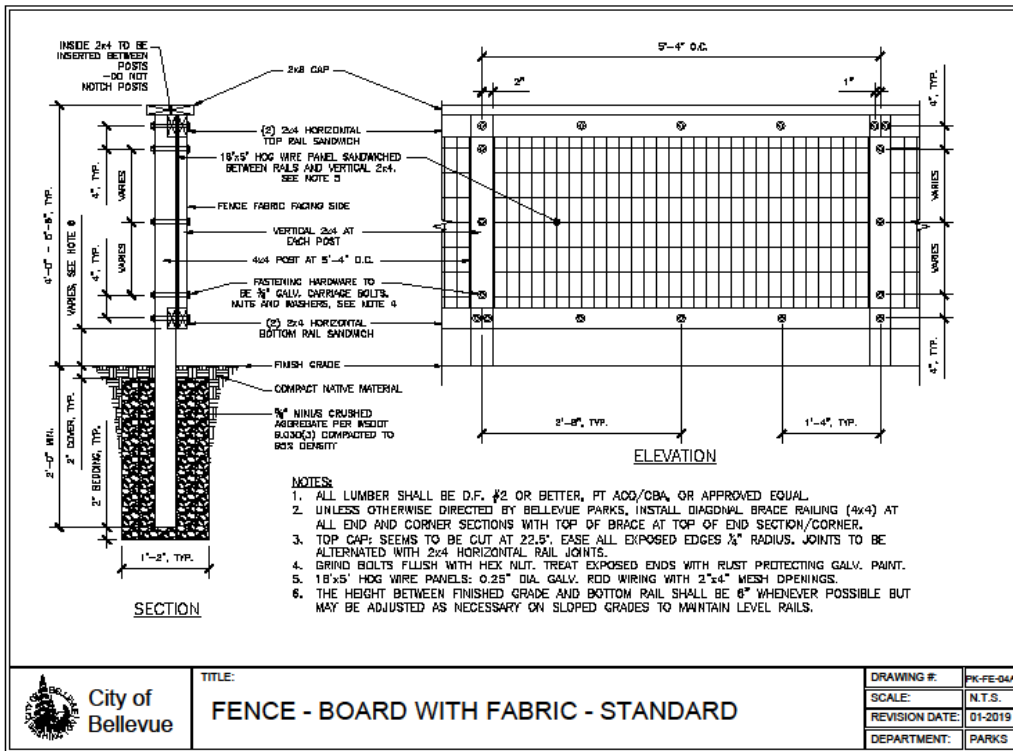
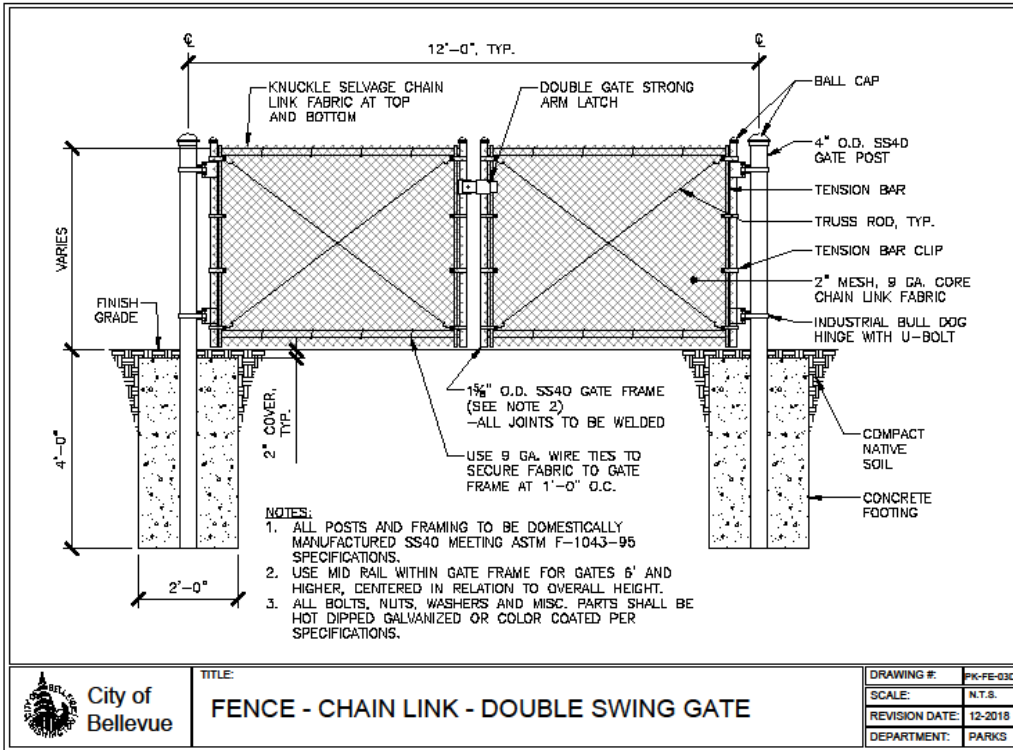

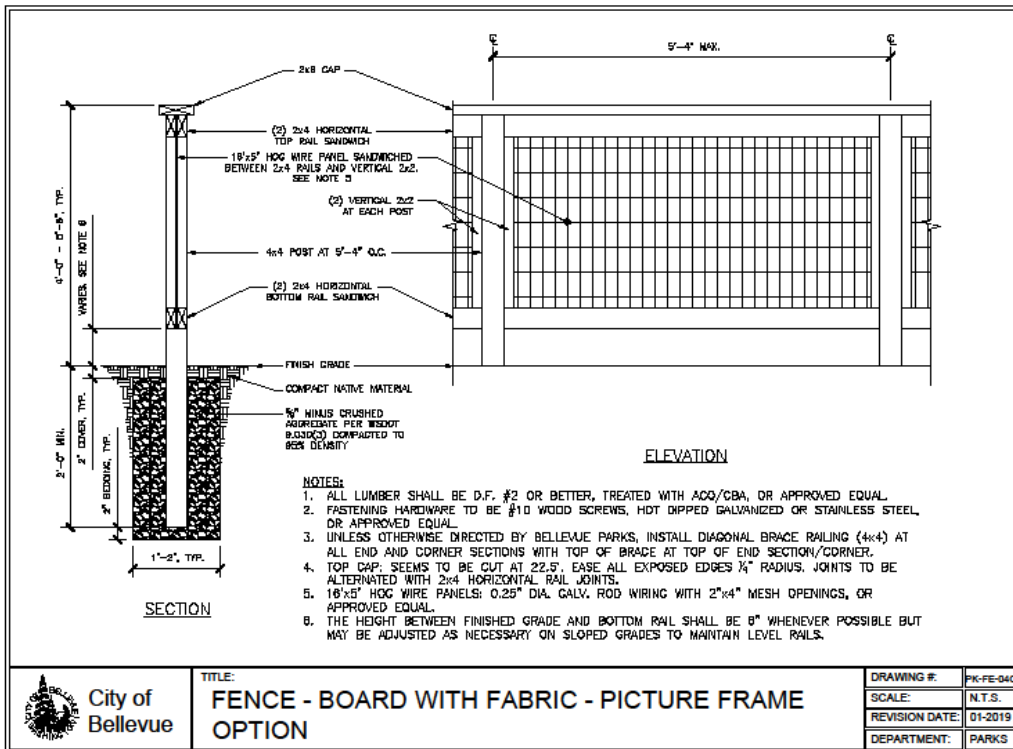
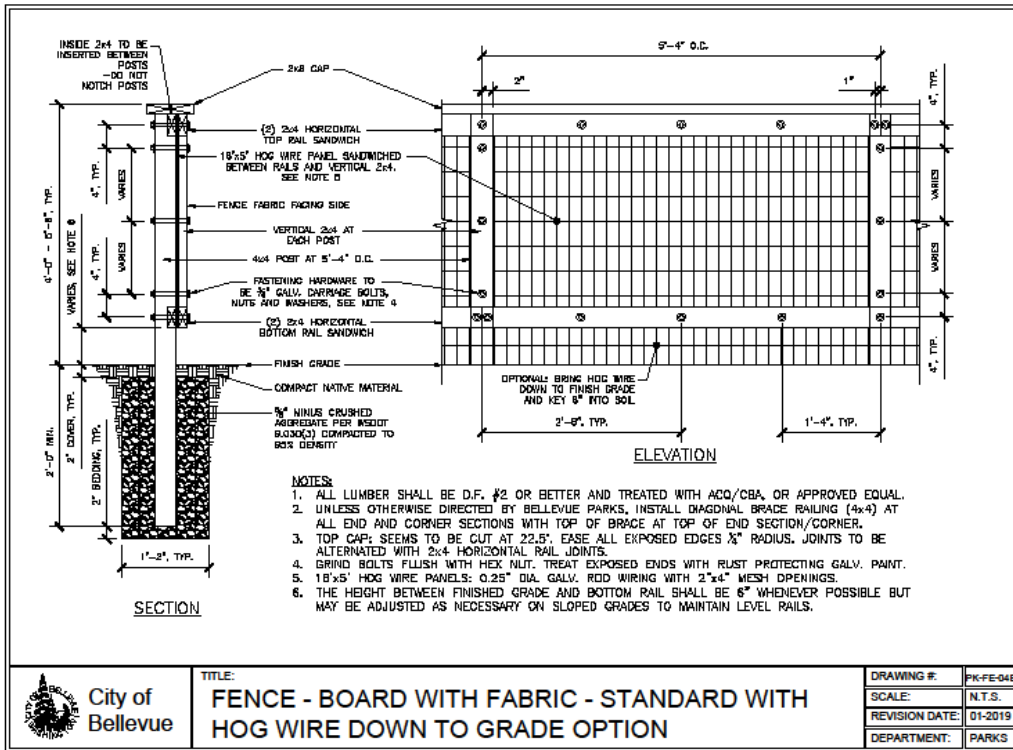

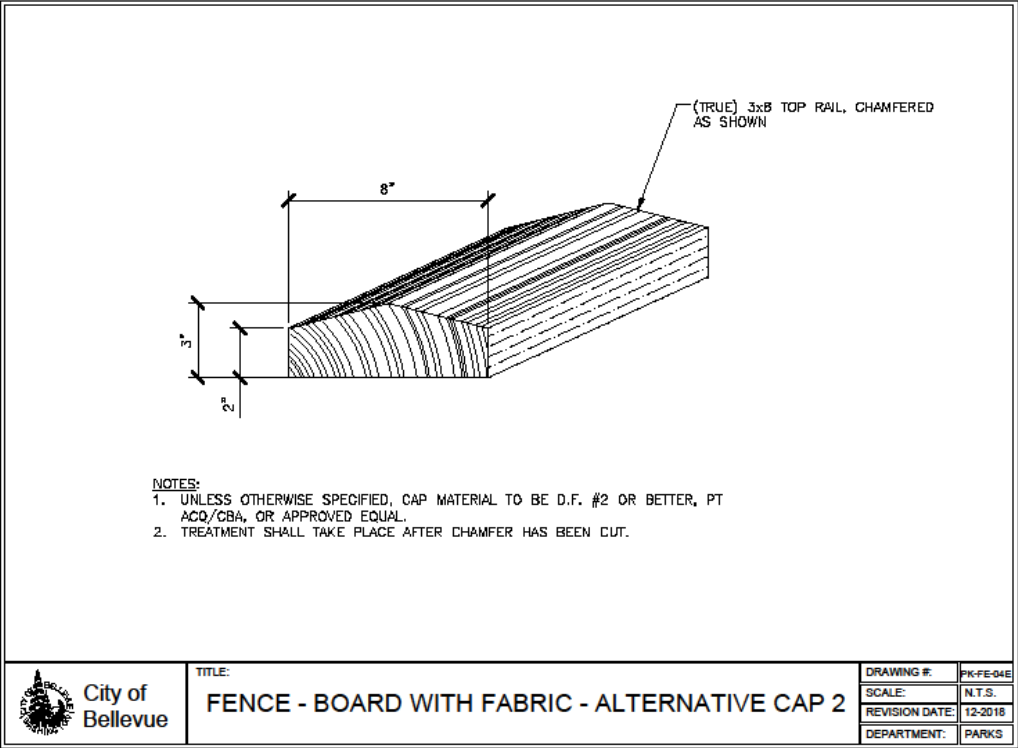
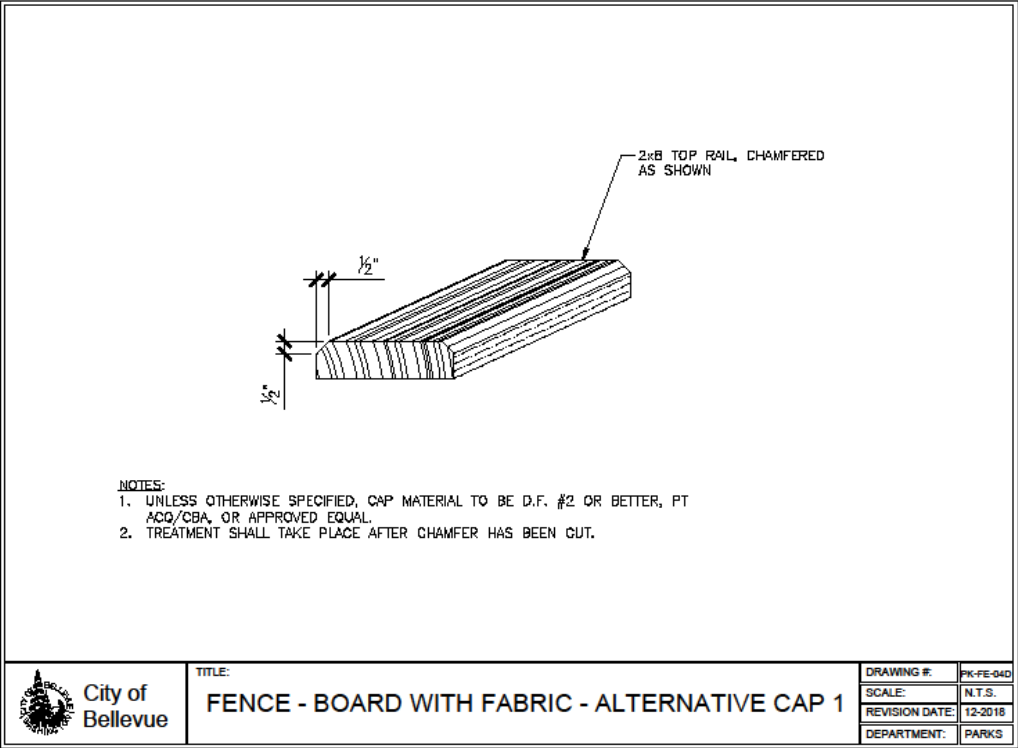

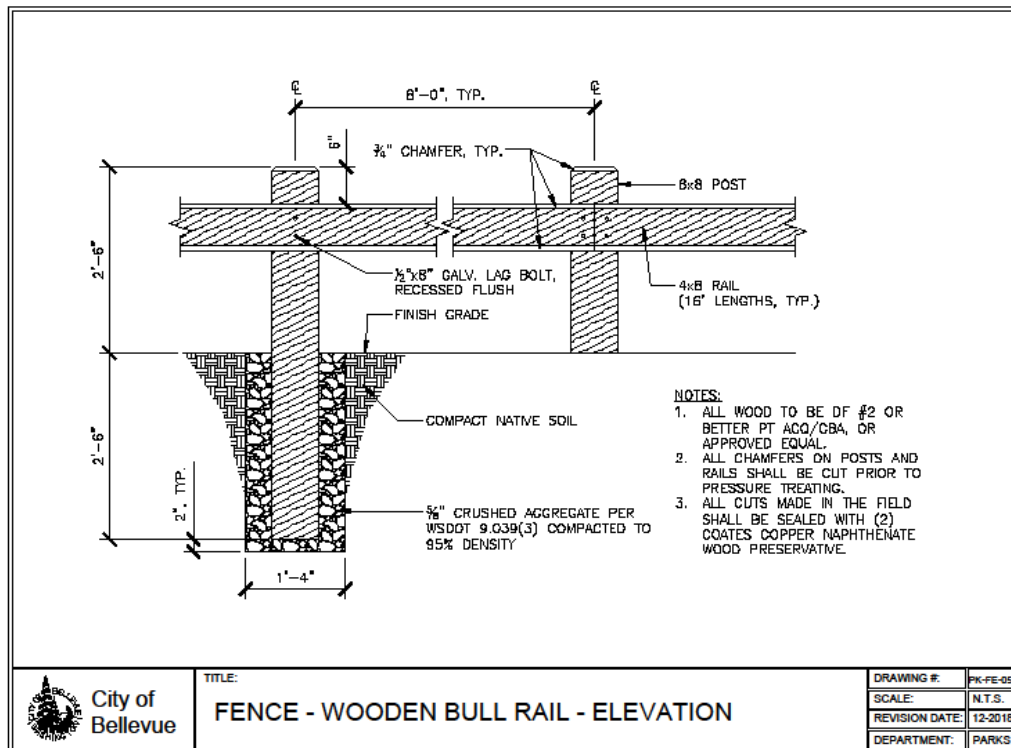
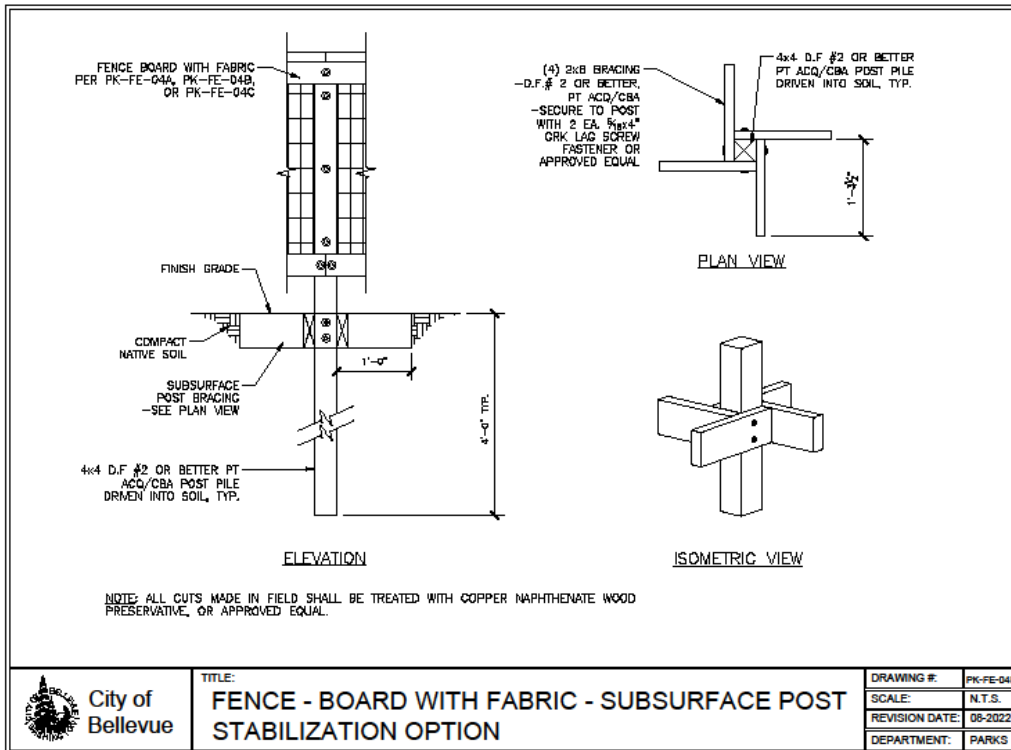



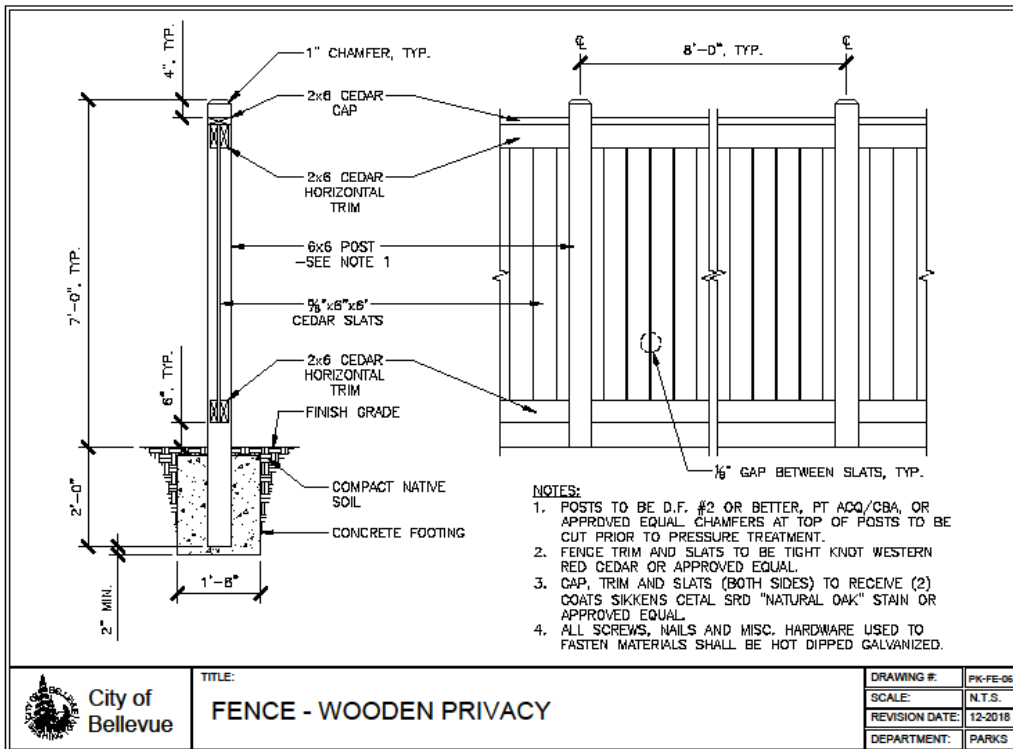
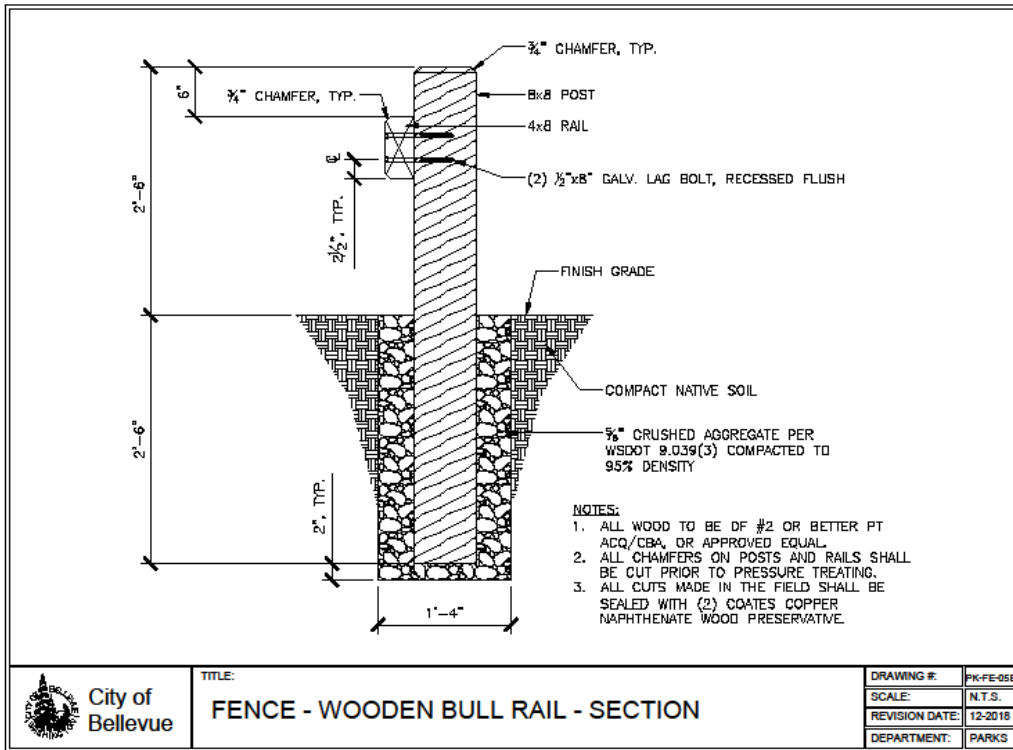

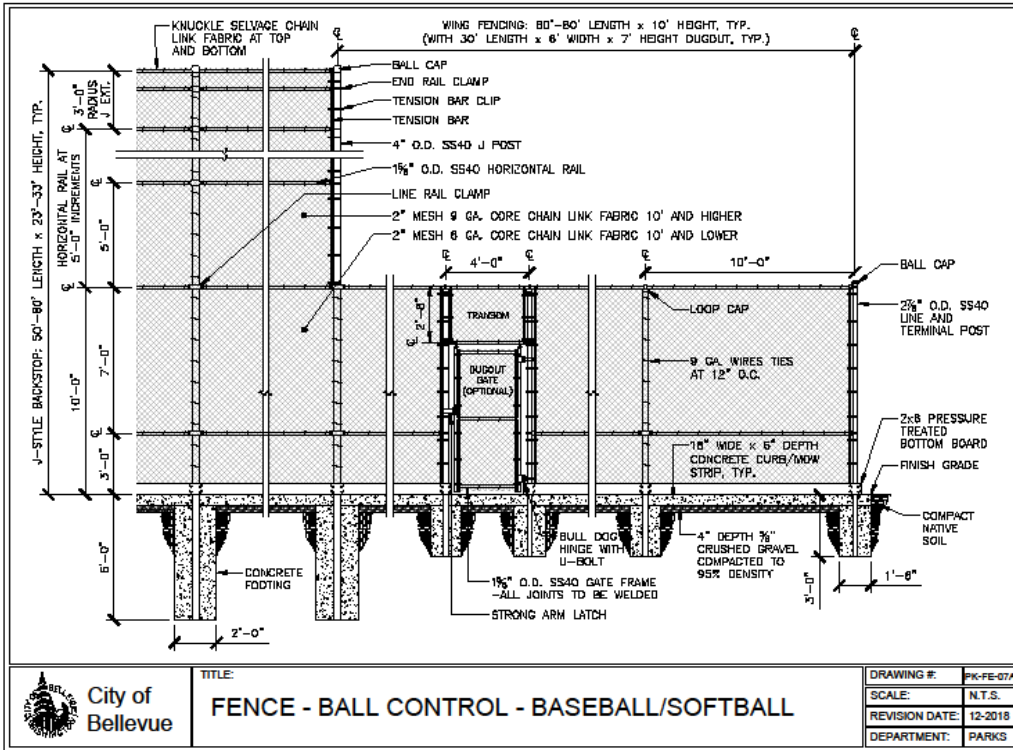

City of Bellevue

TITLE: FENCE - BALL CONTROL - BASEBALL/SOFTBALL

DRAWING #:	PK-FE-07A
SCALE:	N.T.S.
REVISION DATE:	12-2018
DEPARTMENT:	PARKS

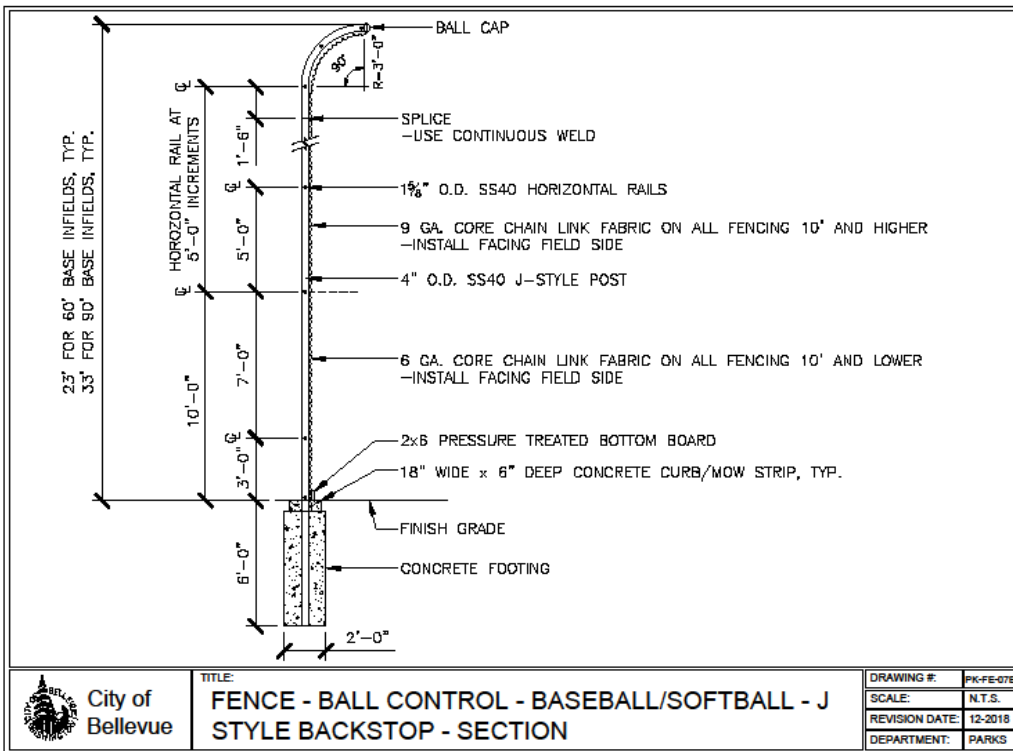

City of Bellevue

TITLE: FENCE - BALL CONTROL - BASEBALL/SOFTBALL - J STYLE BACKSTOP - SECTION

DRAWING #:	PK-FE-07B
SCALE:	N.T.S.
REVISION DATE:	12-2018
DEPARTMENT:	PARKS

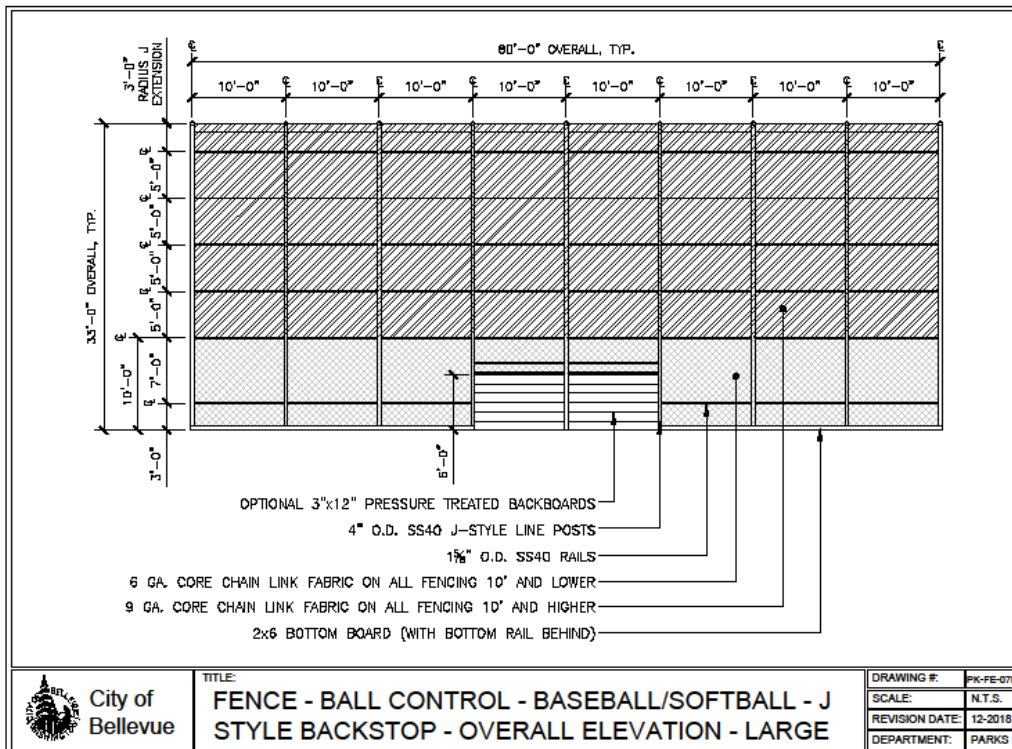
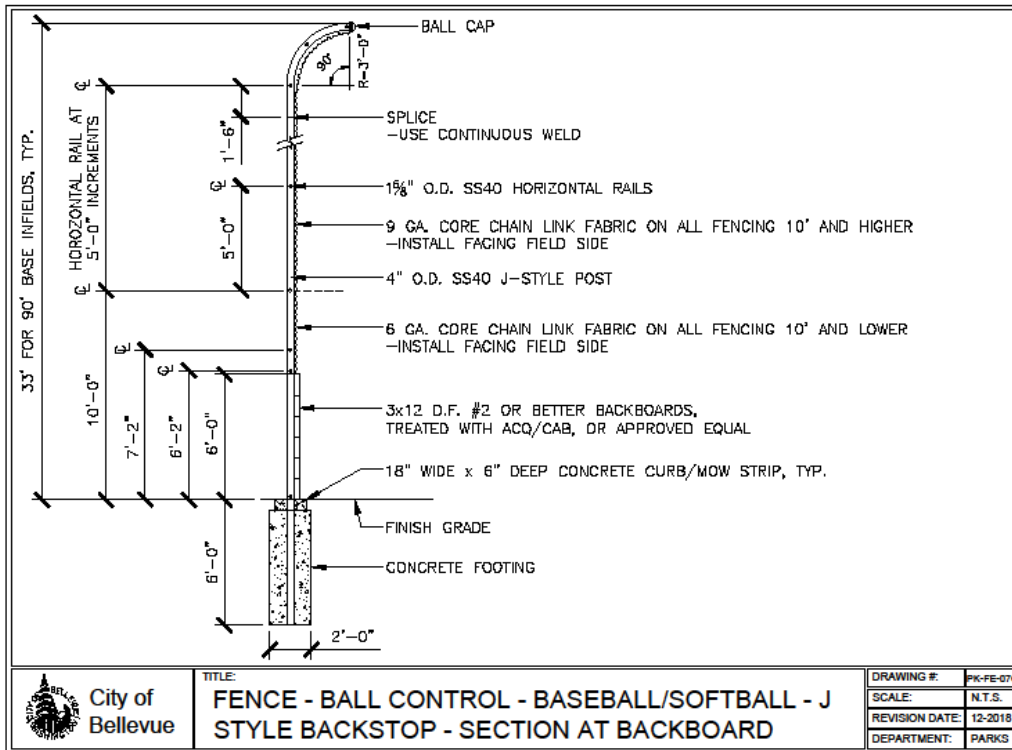

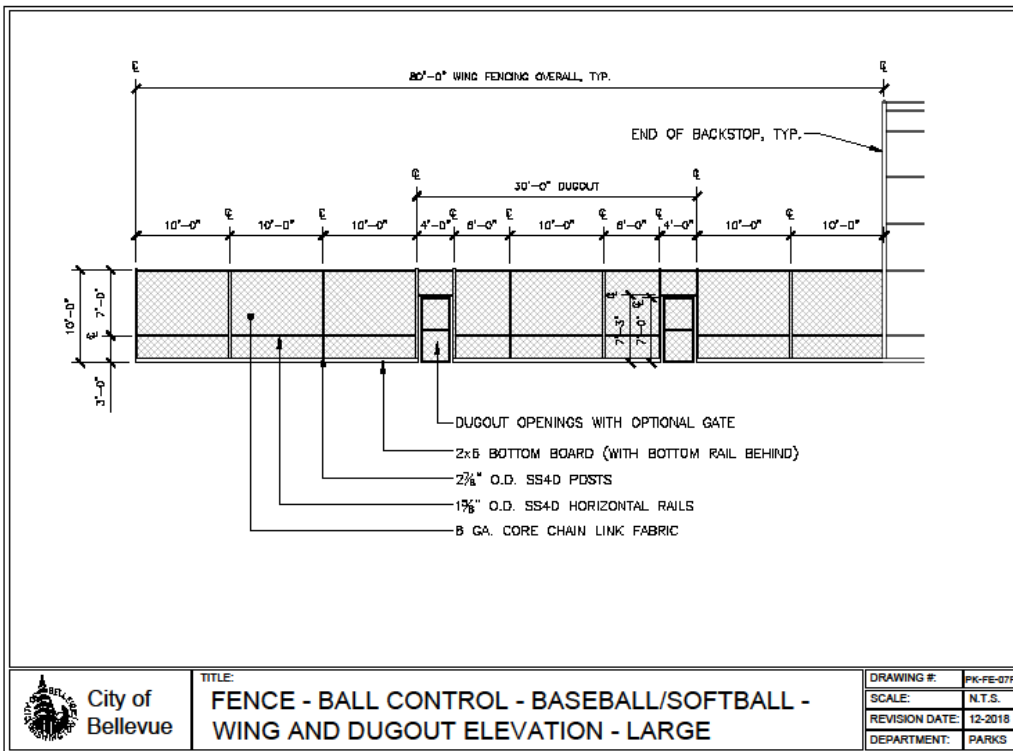
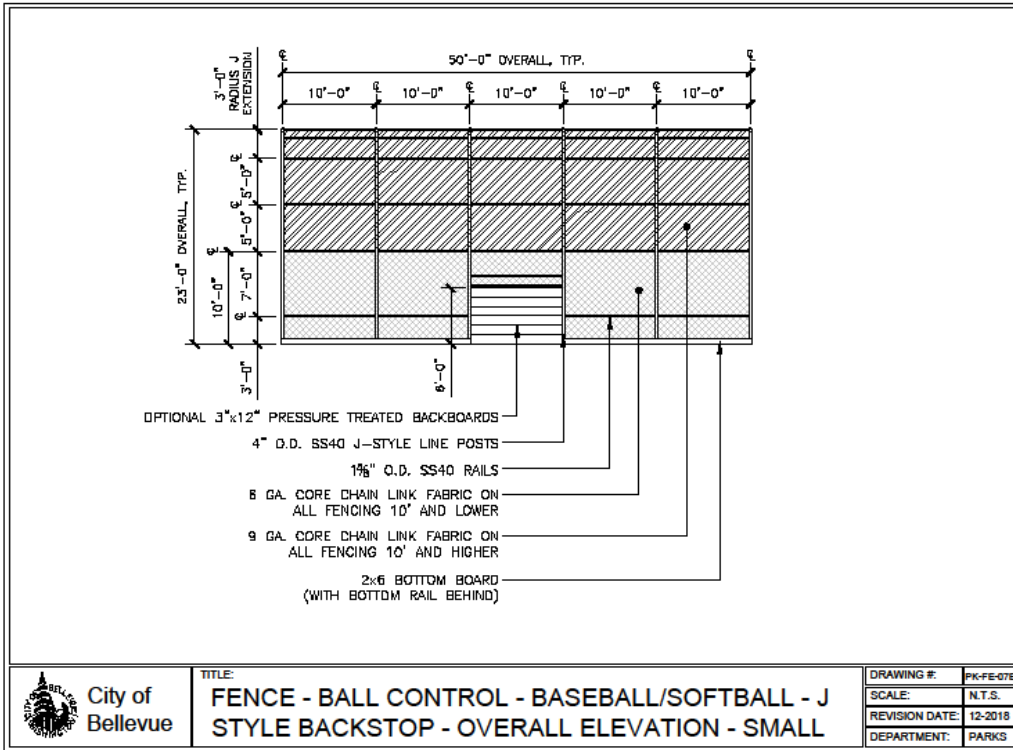



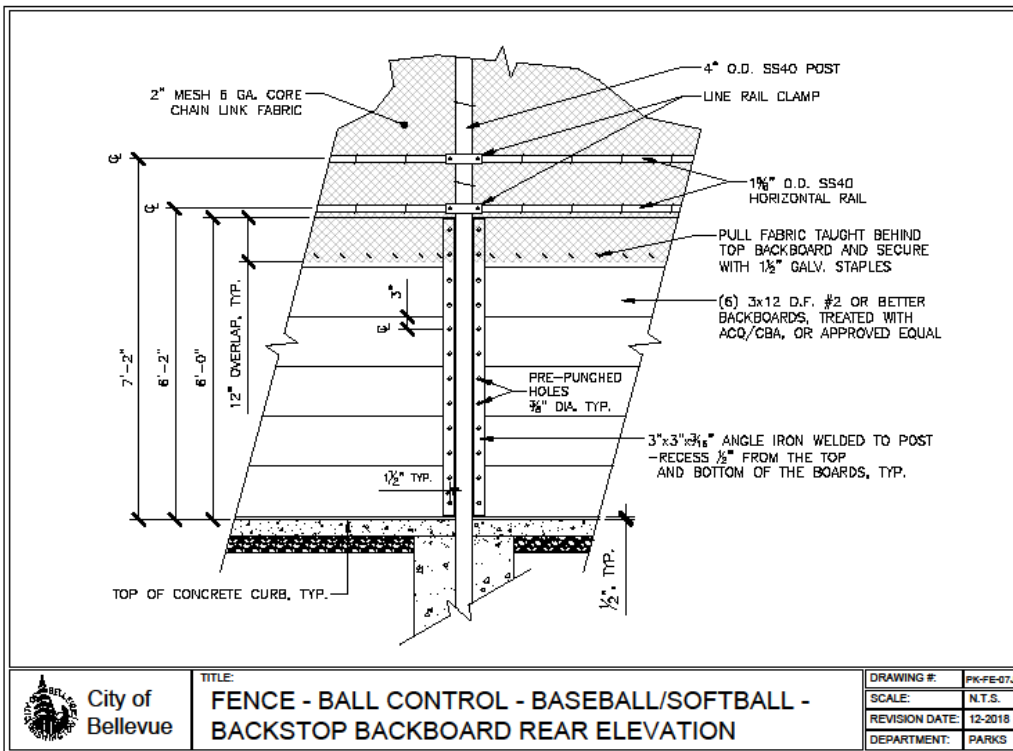
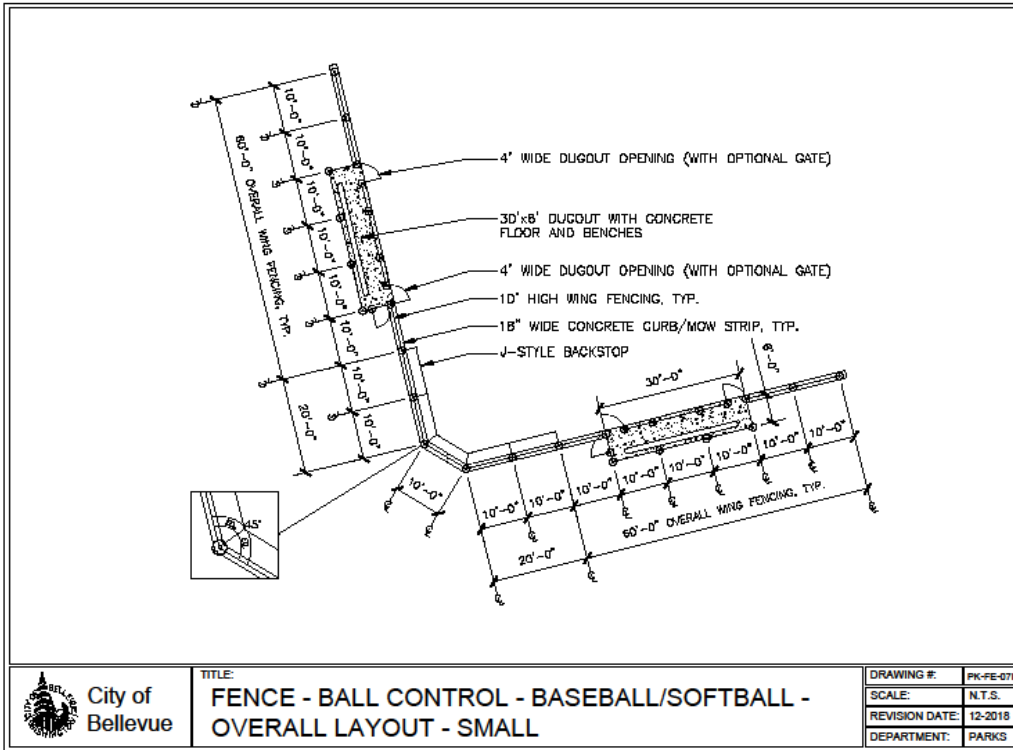

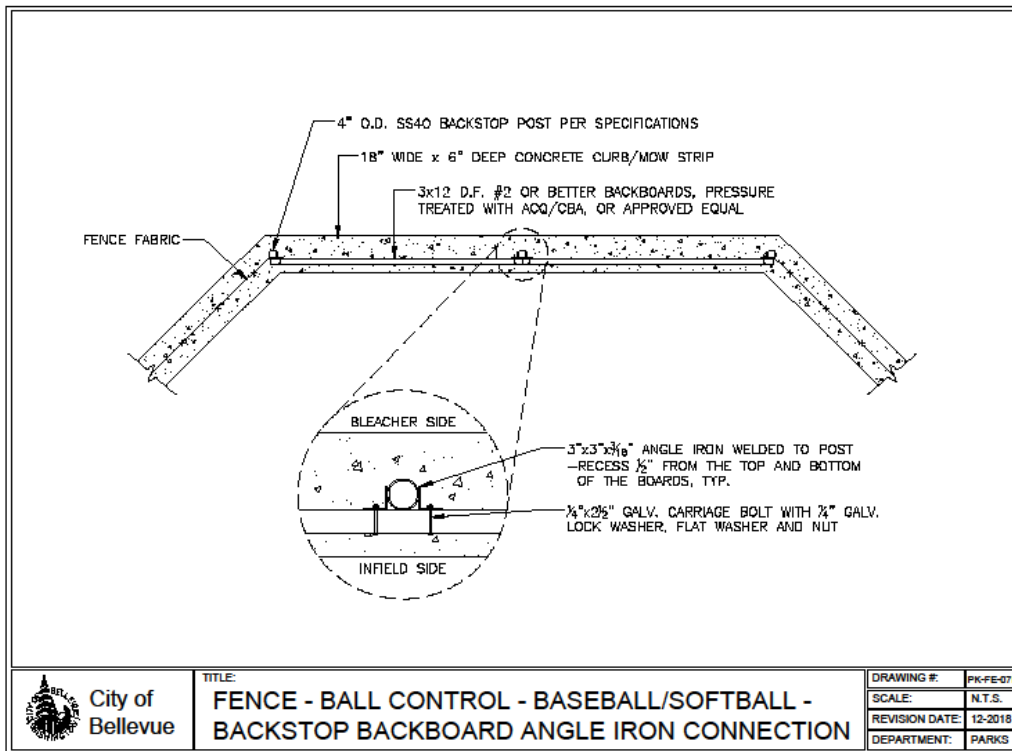
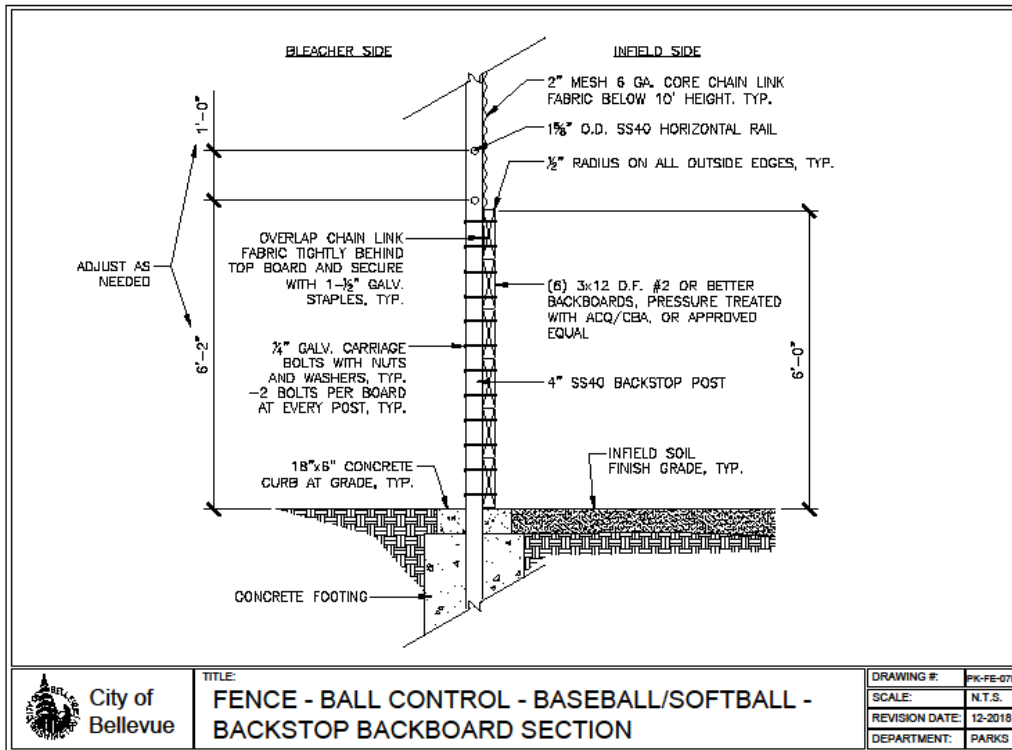

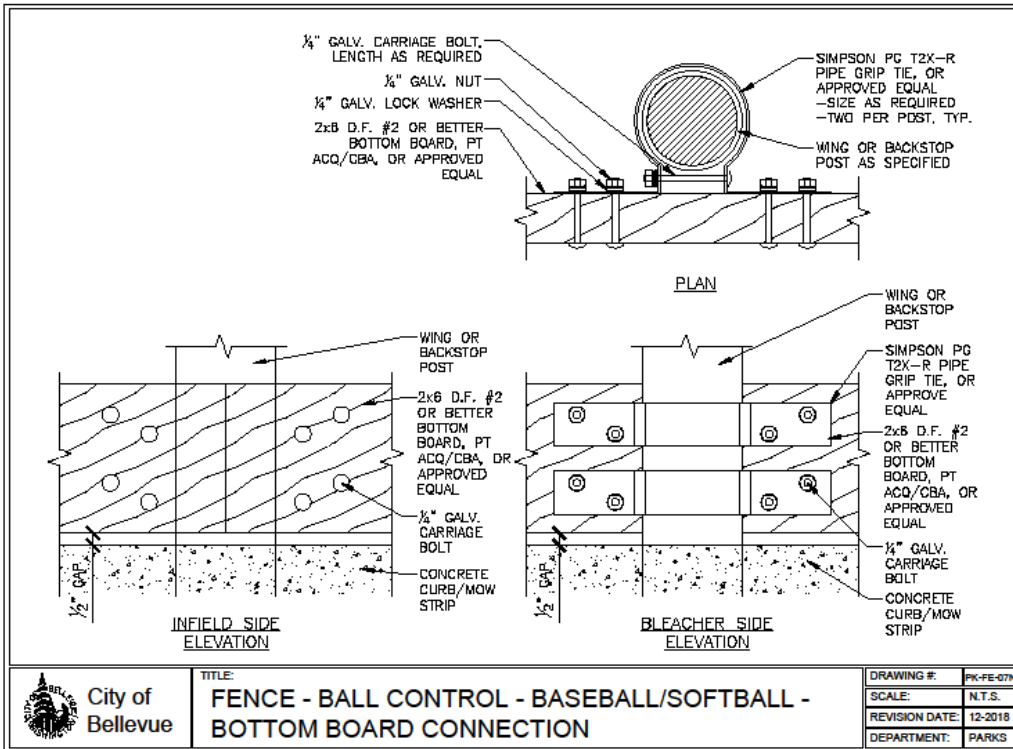
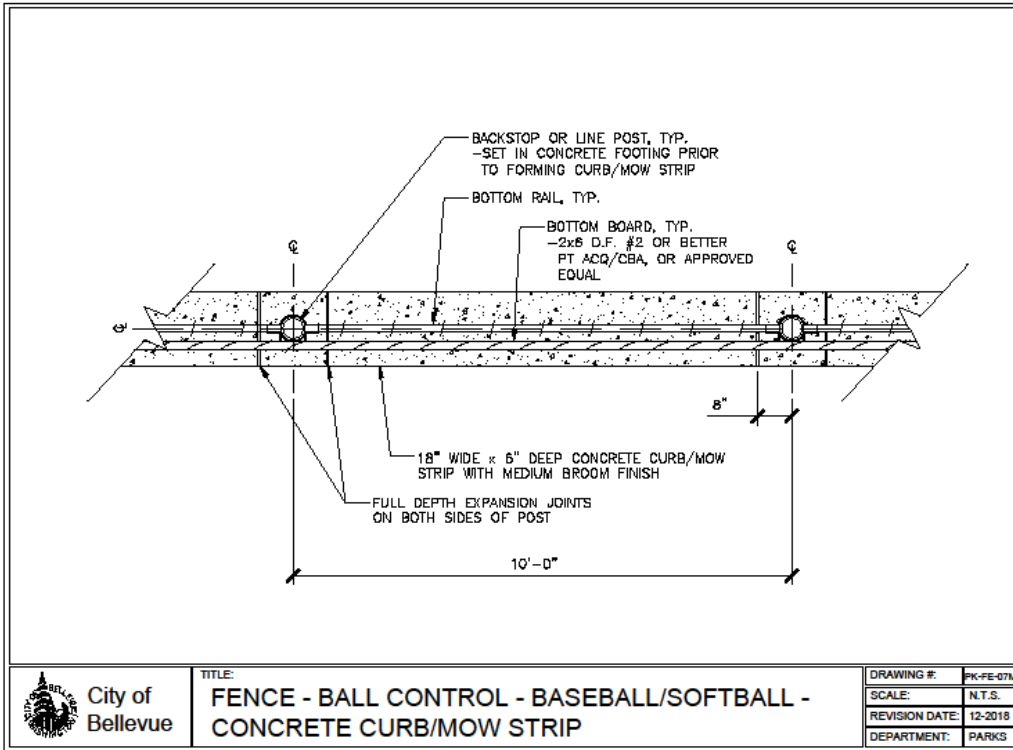



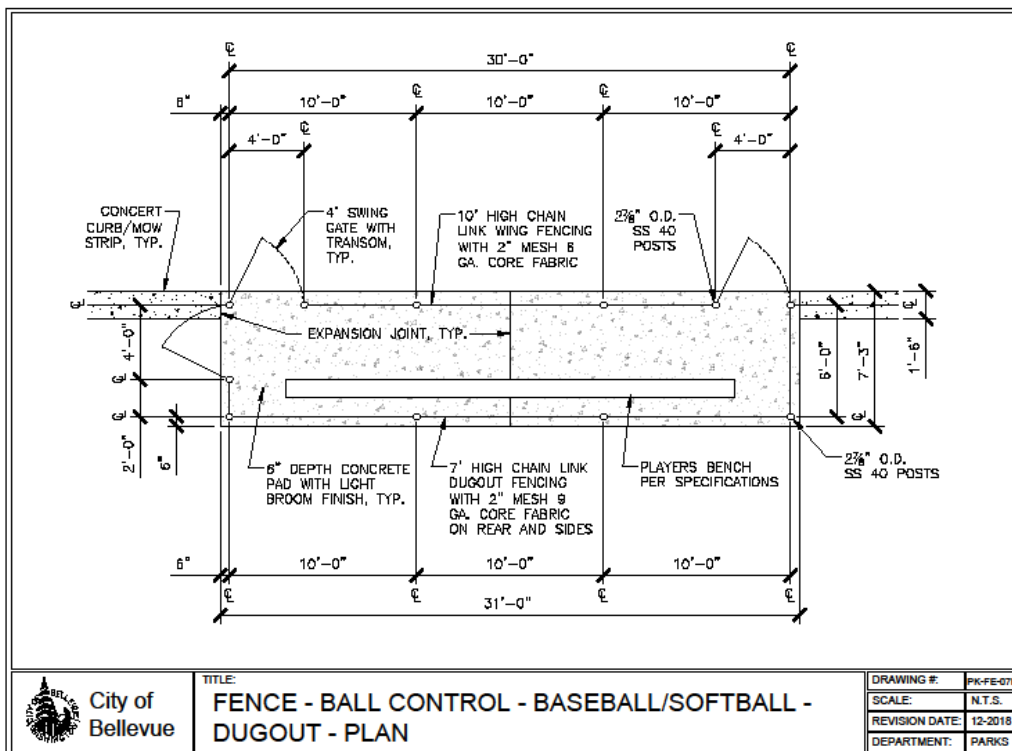
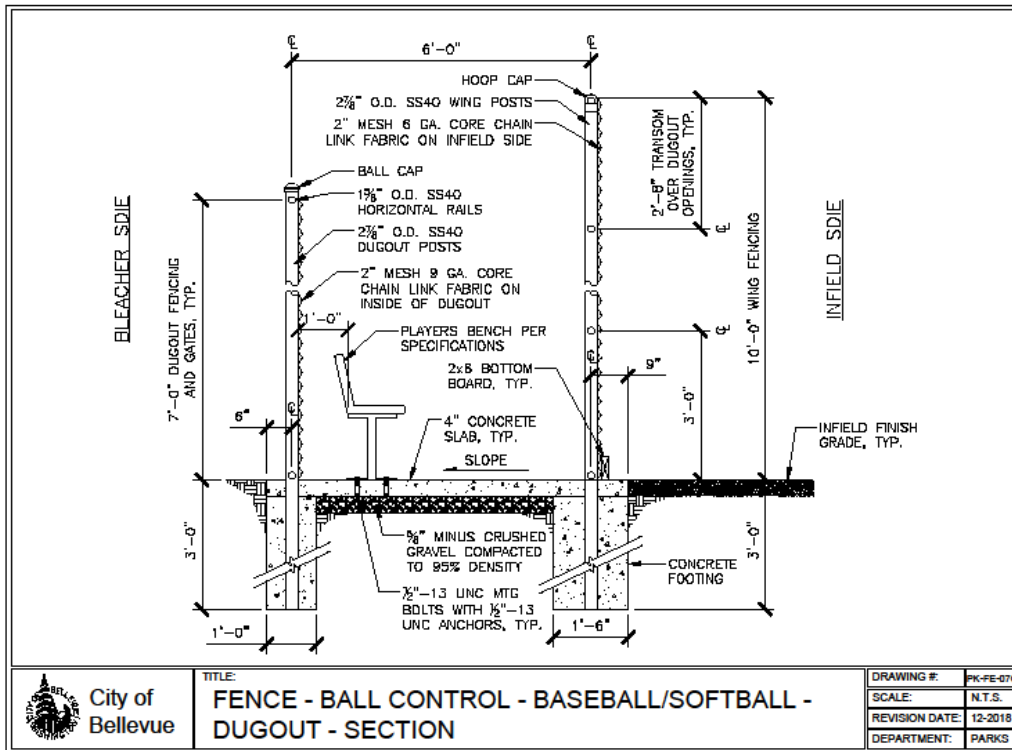

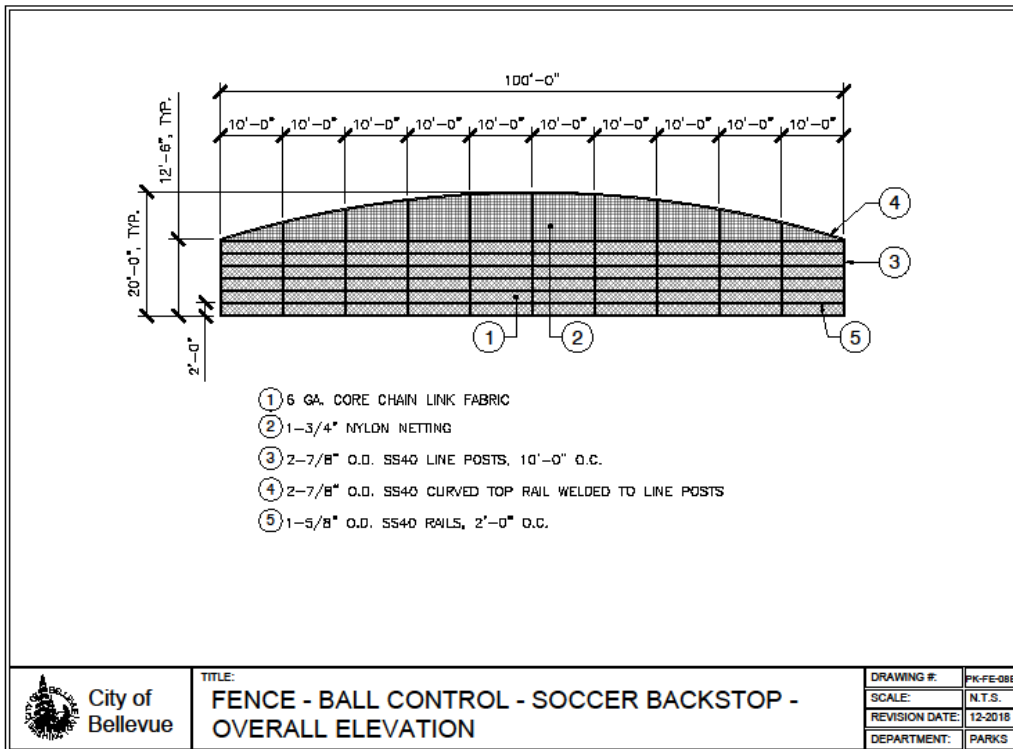
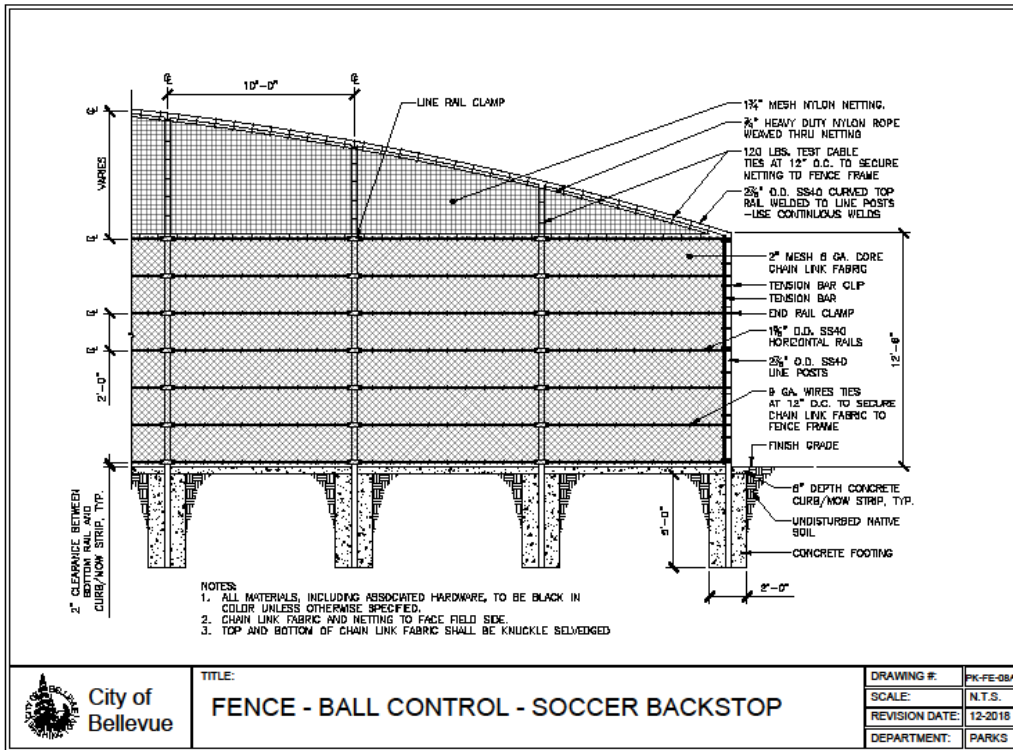

(This page intentionally left blank)

## Site Furnishings

---



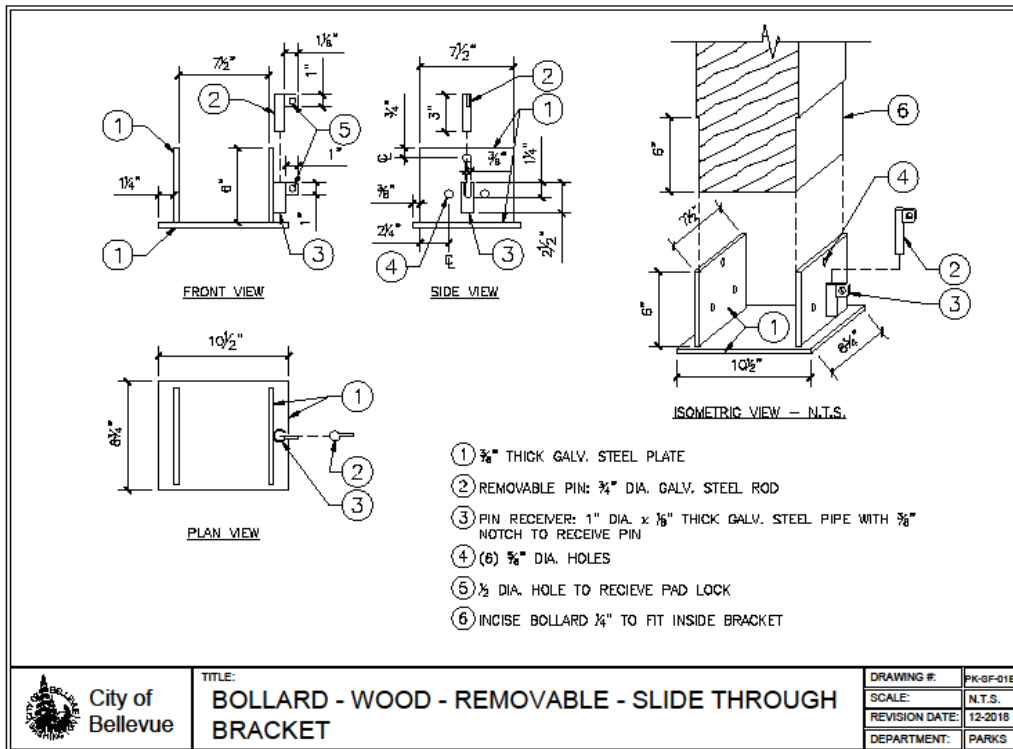
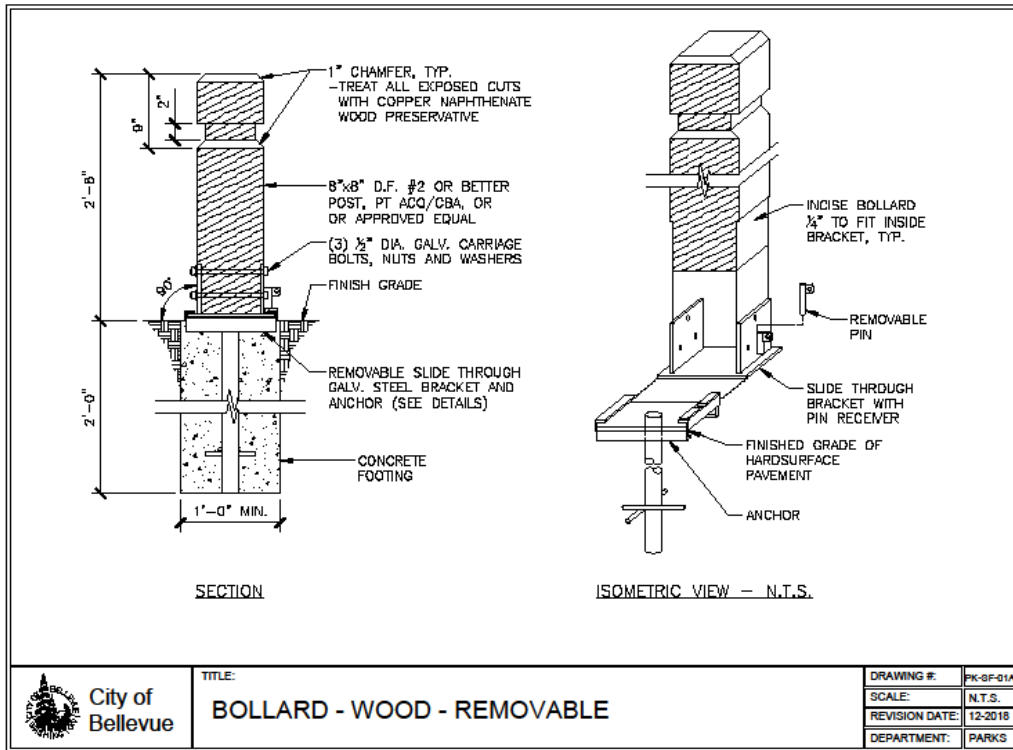

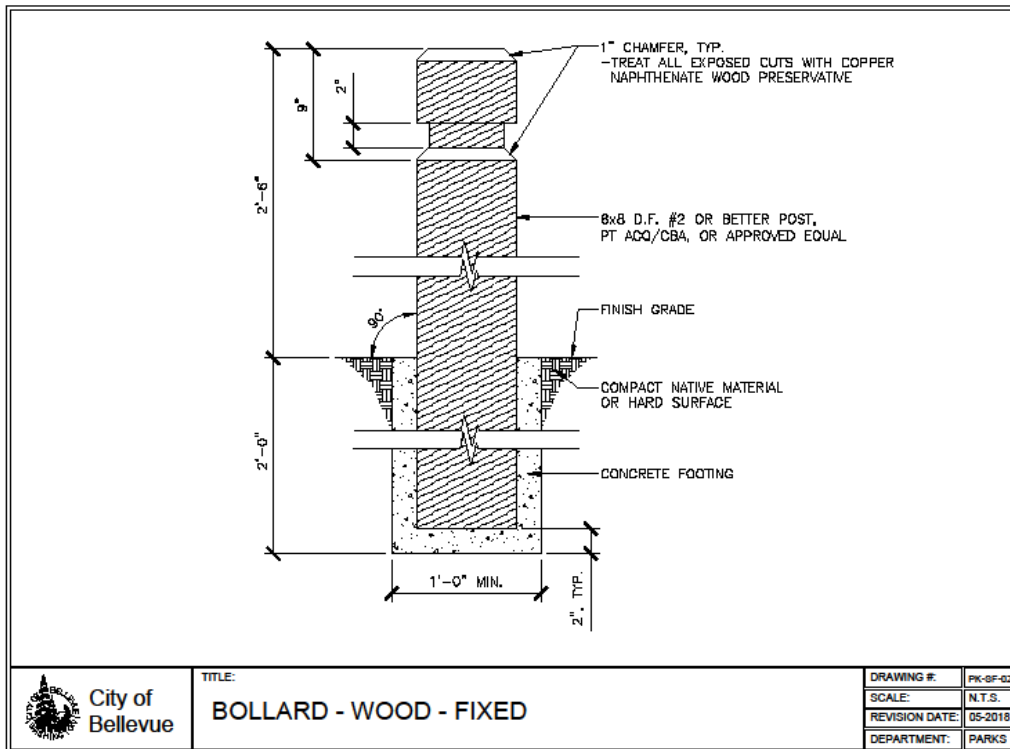
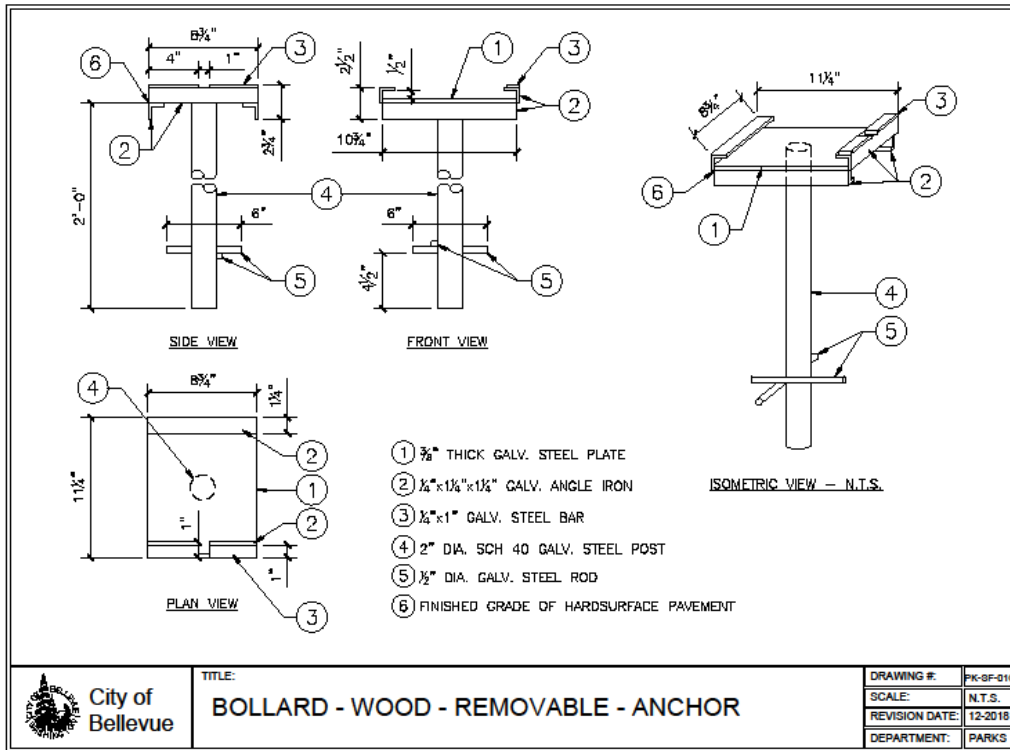

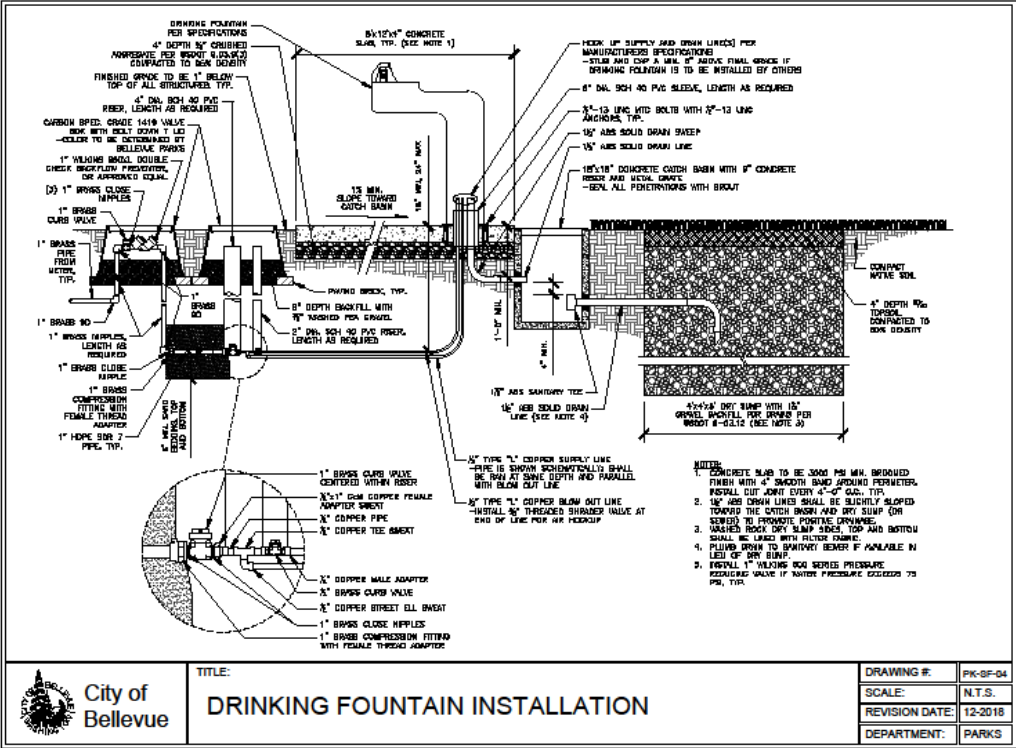
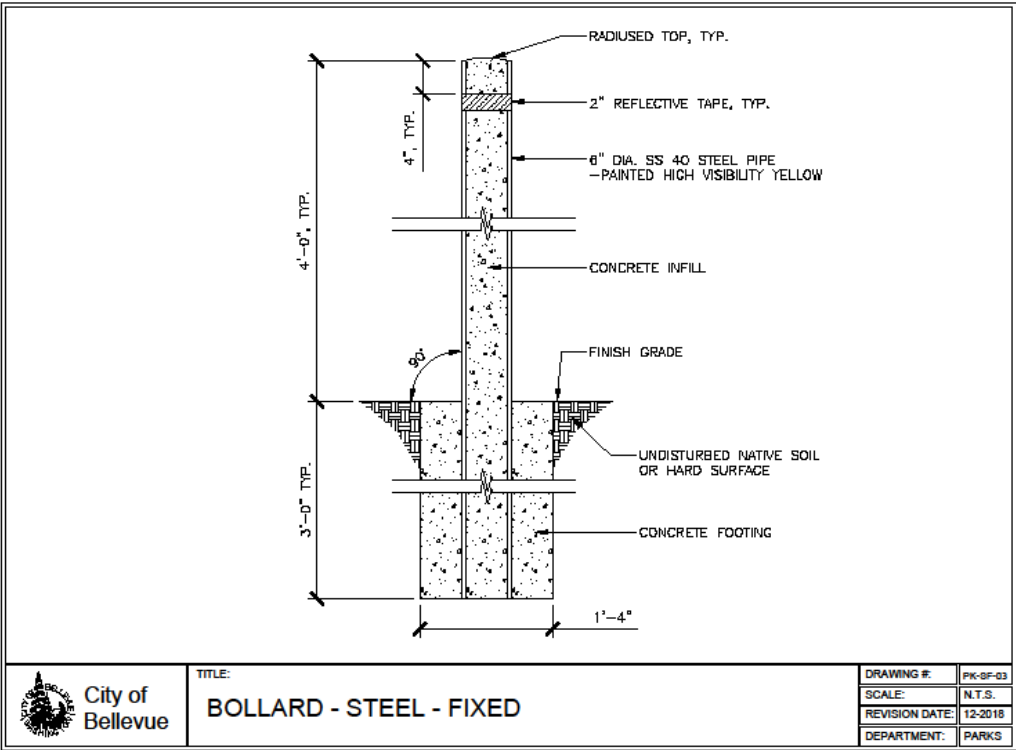

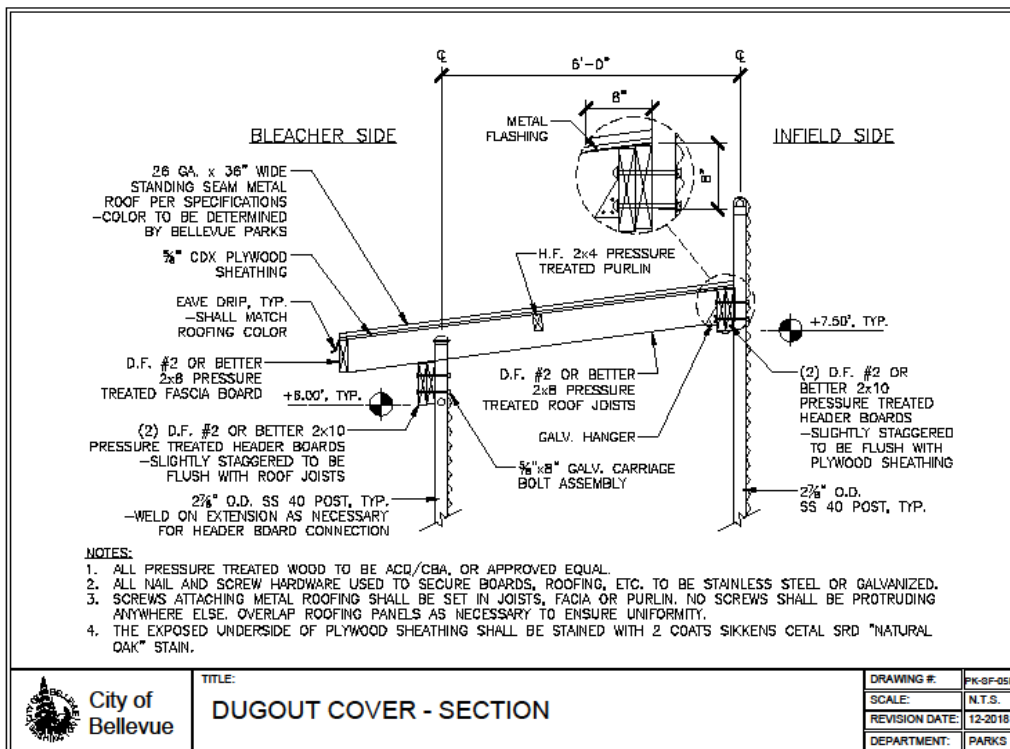
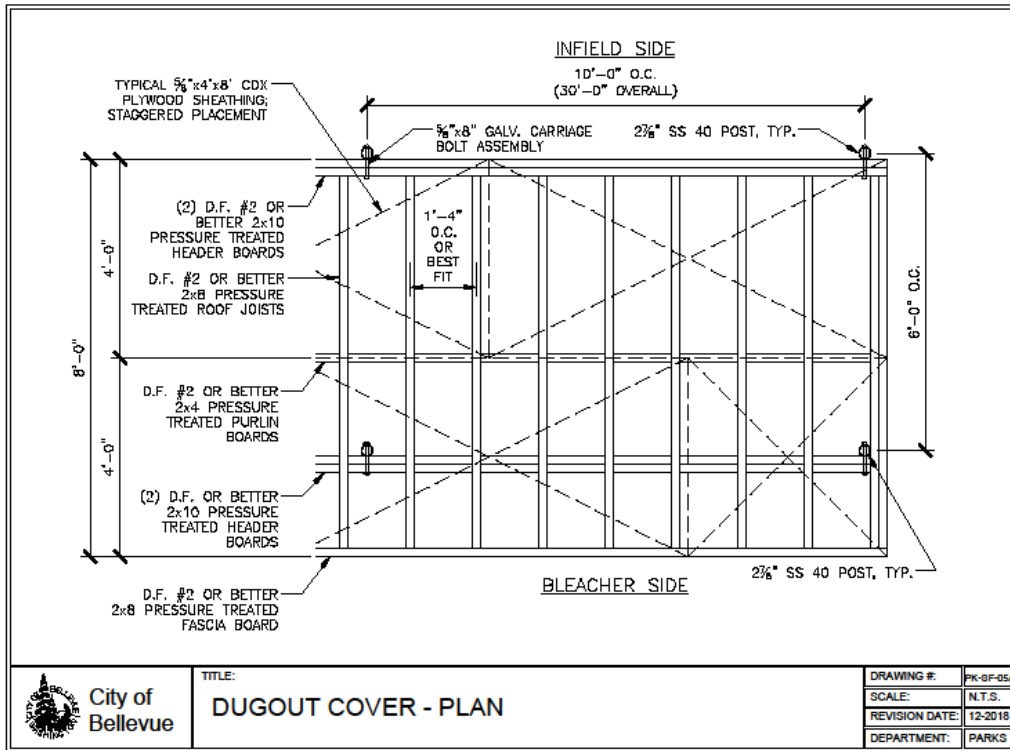



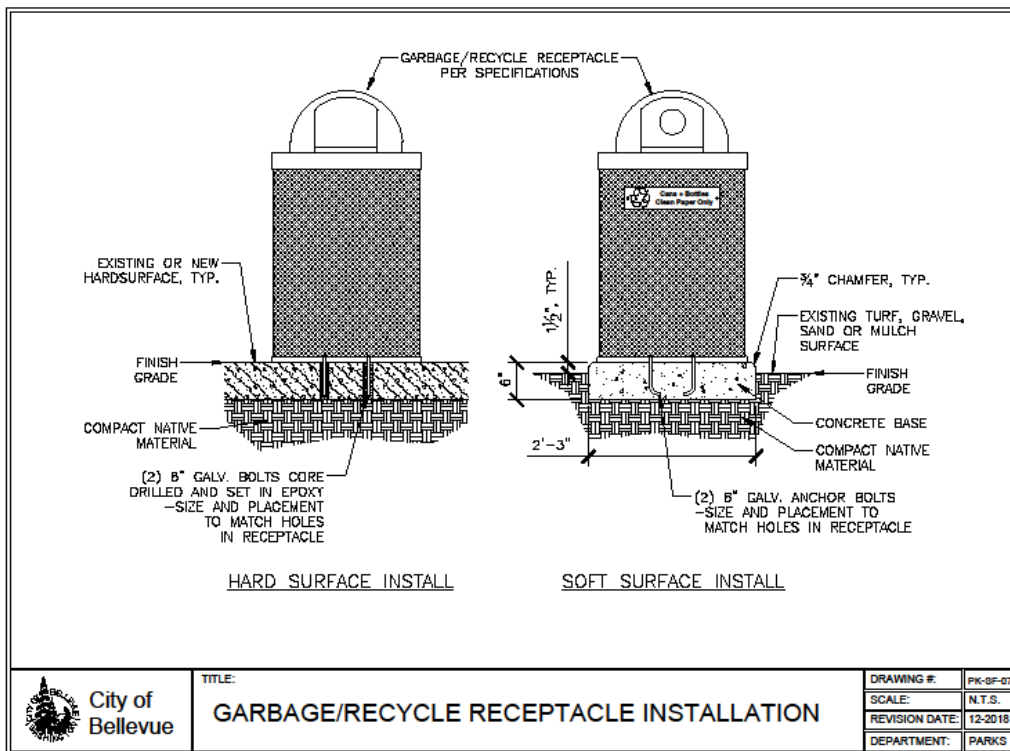
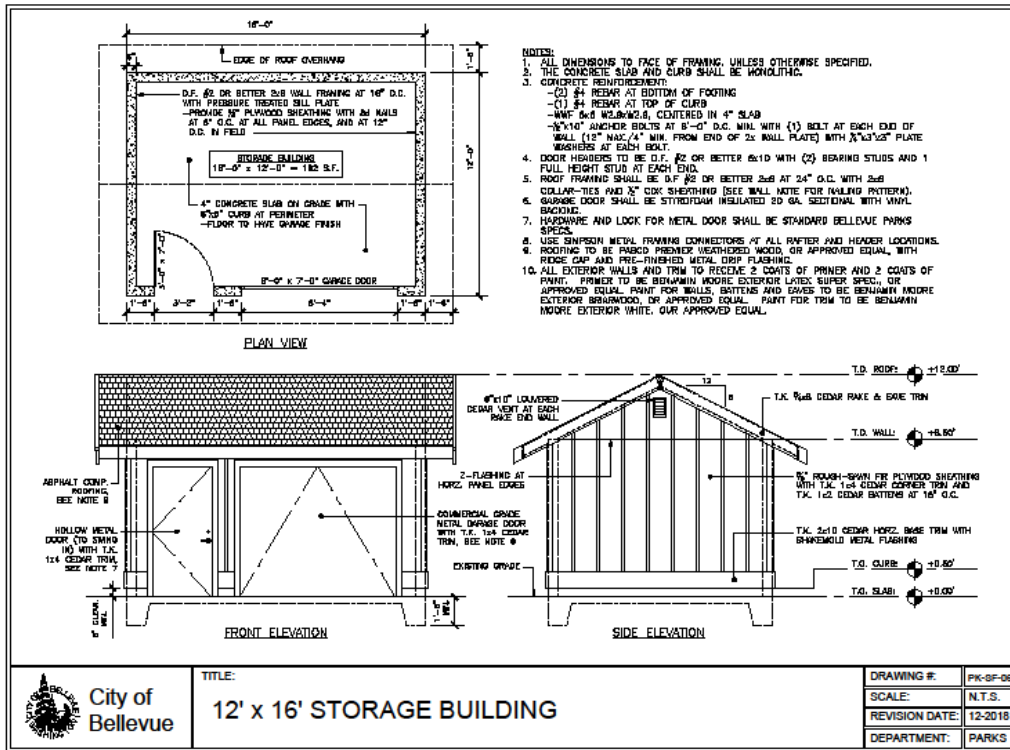

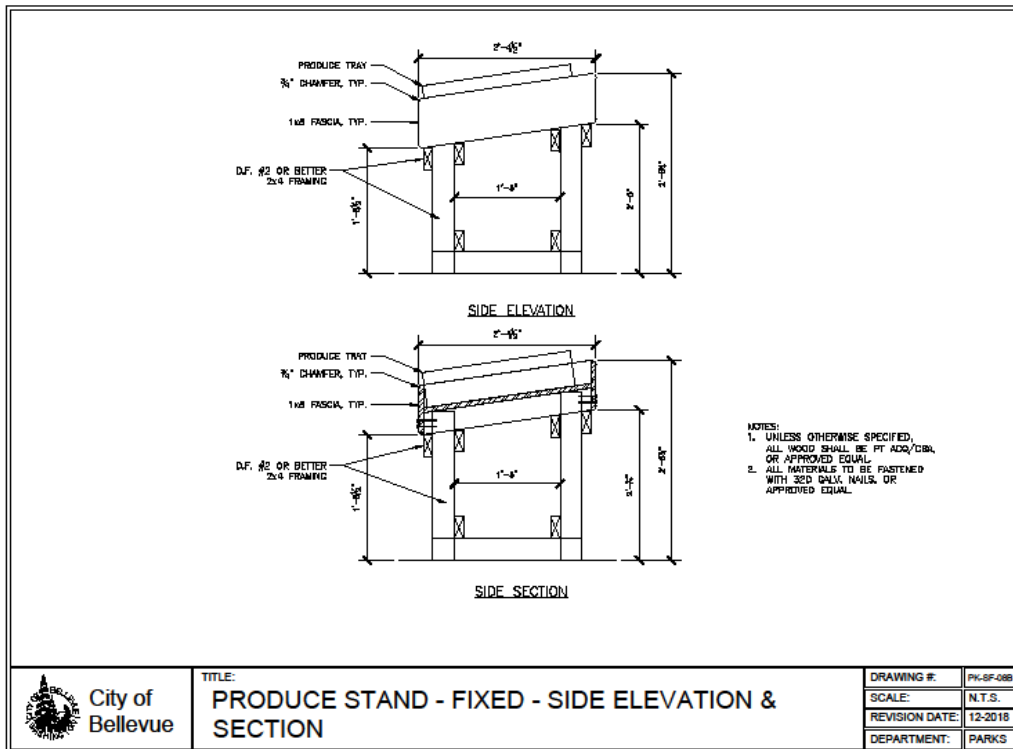
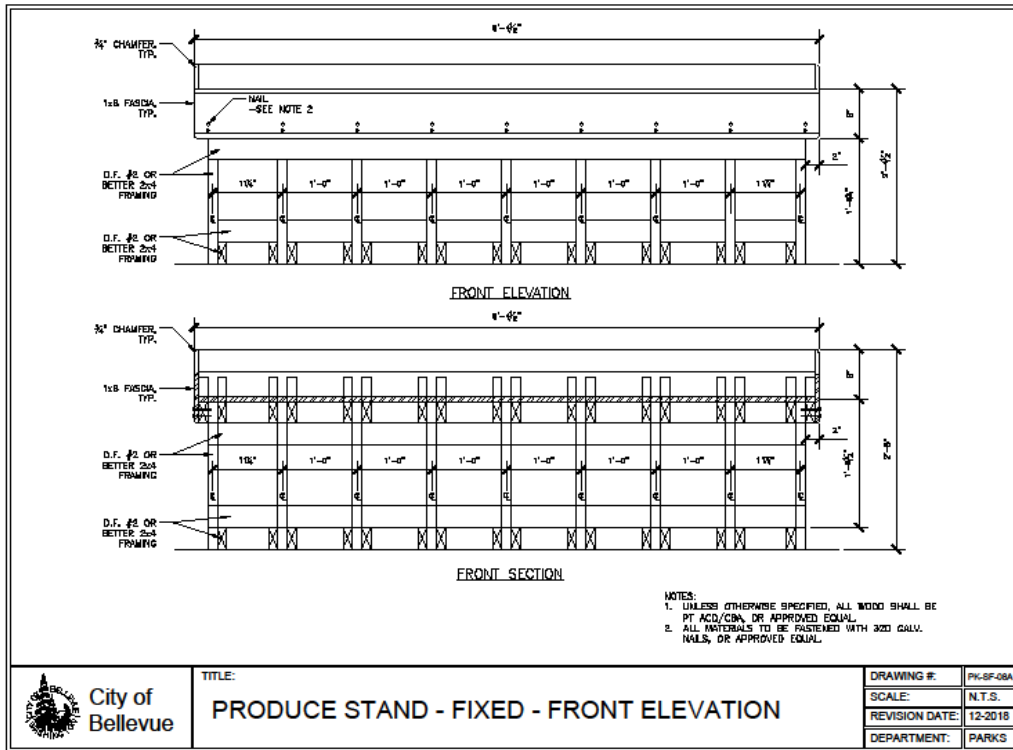

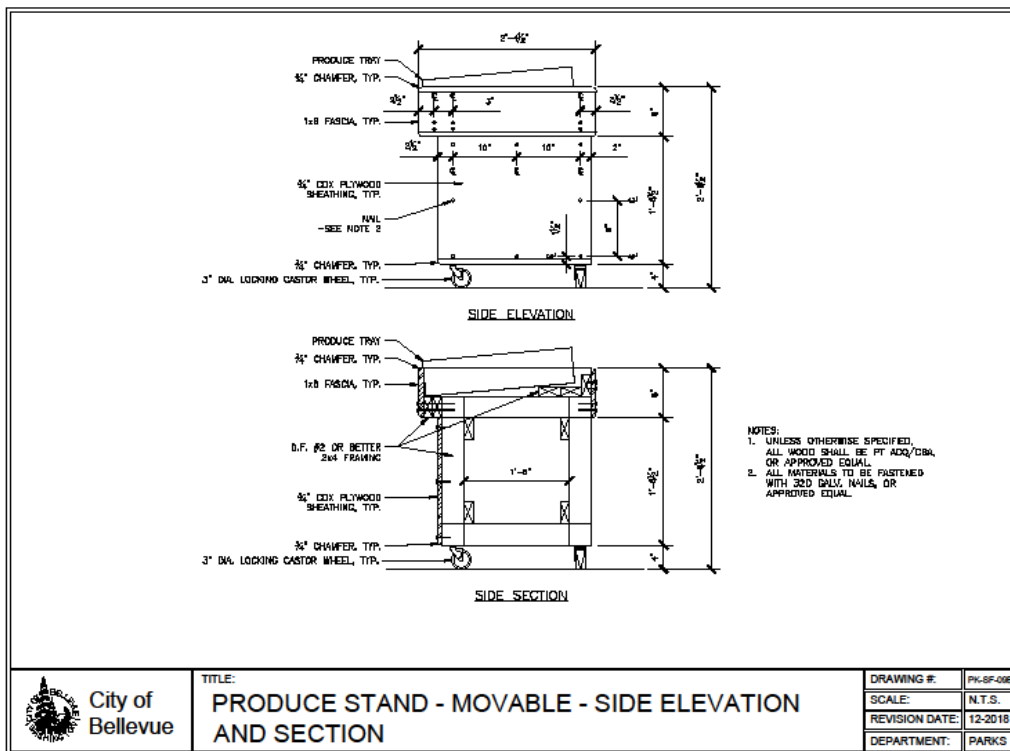
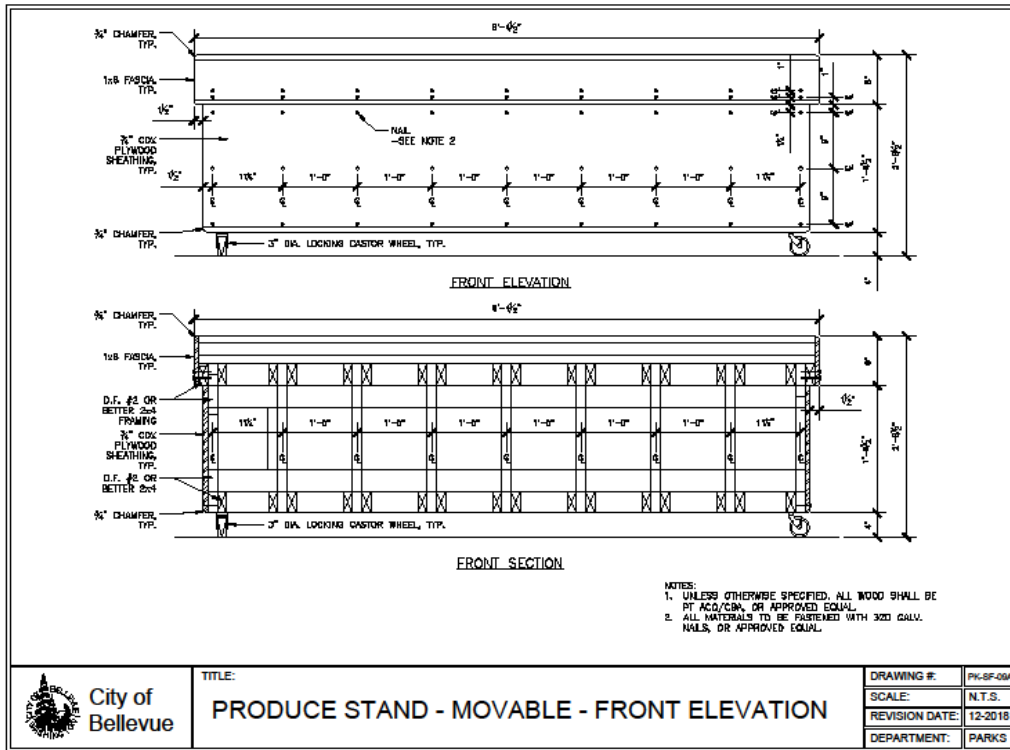

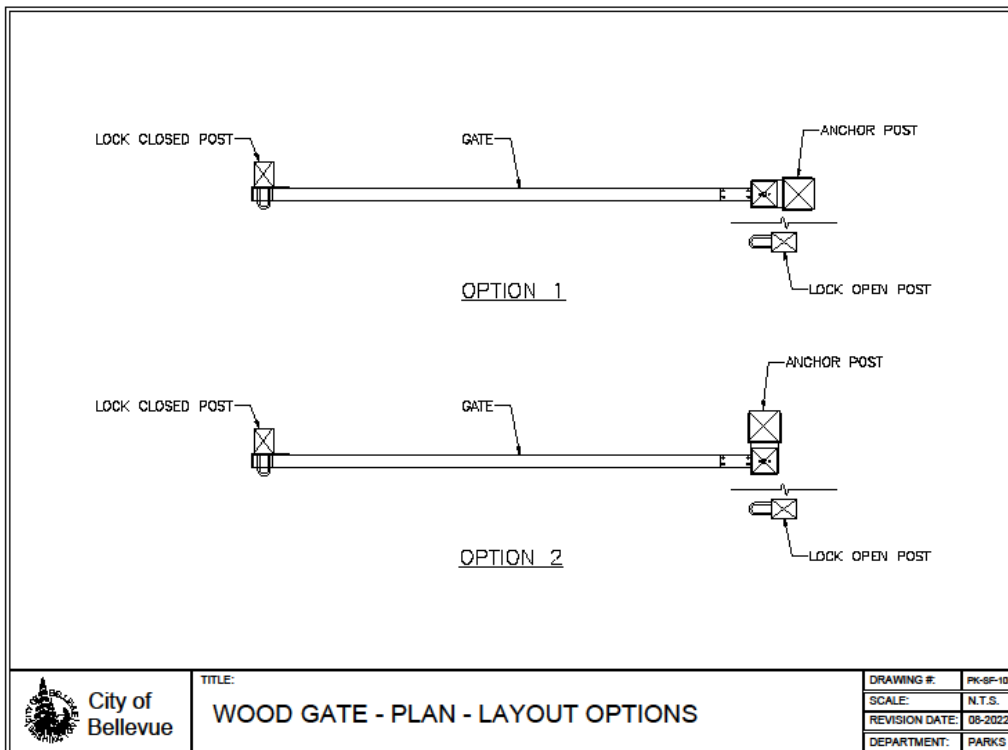
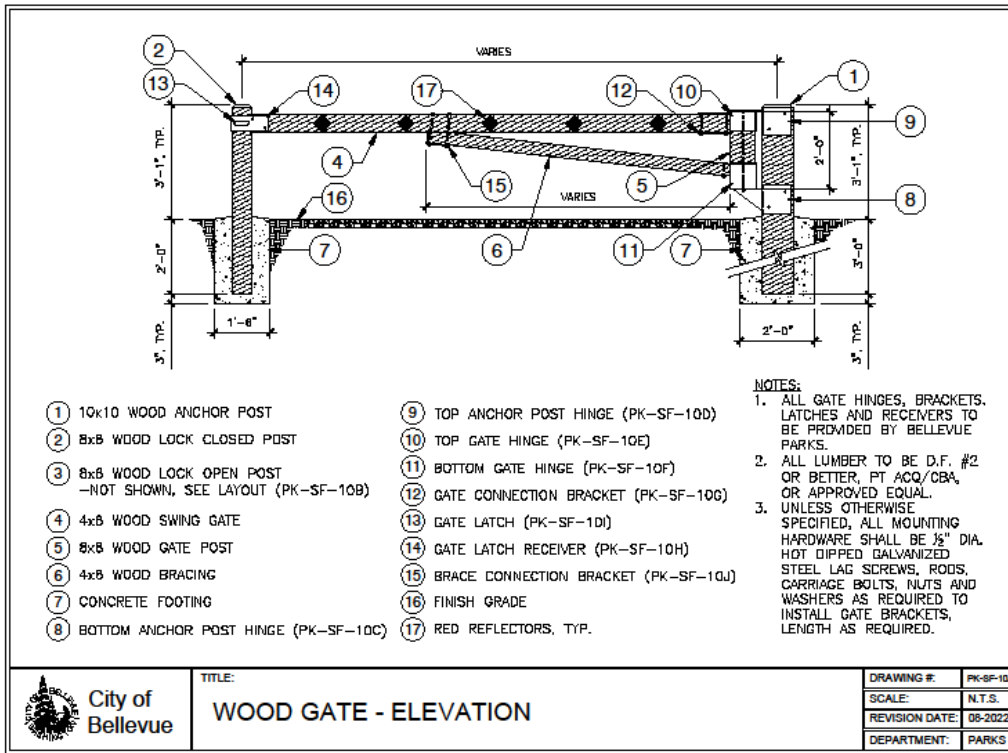

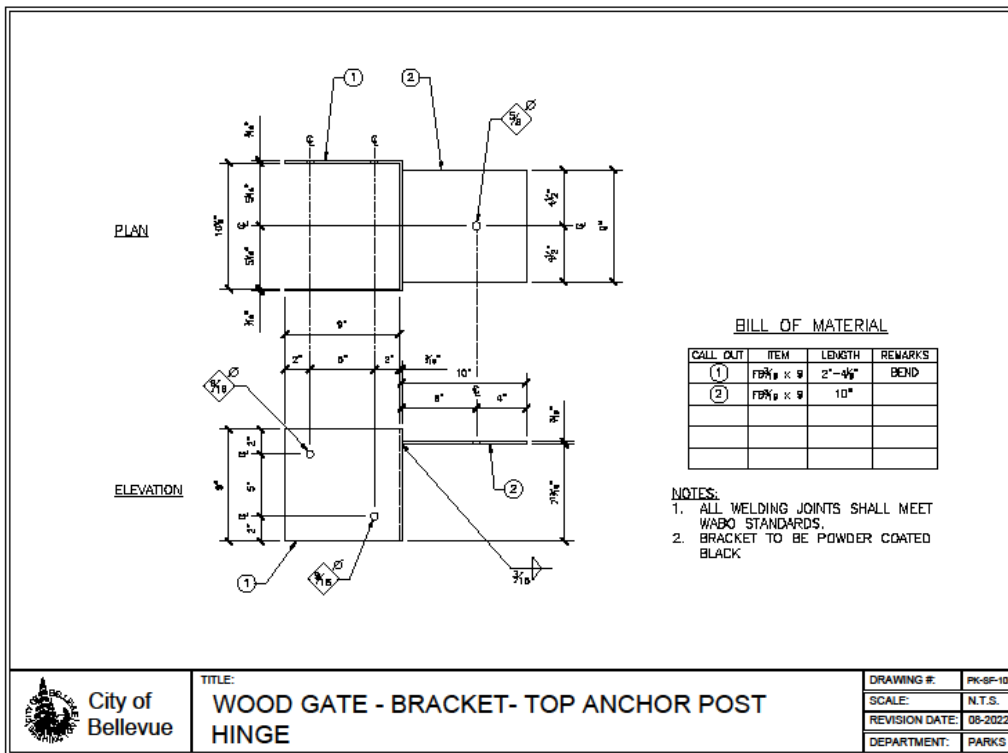
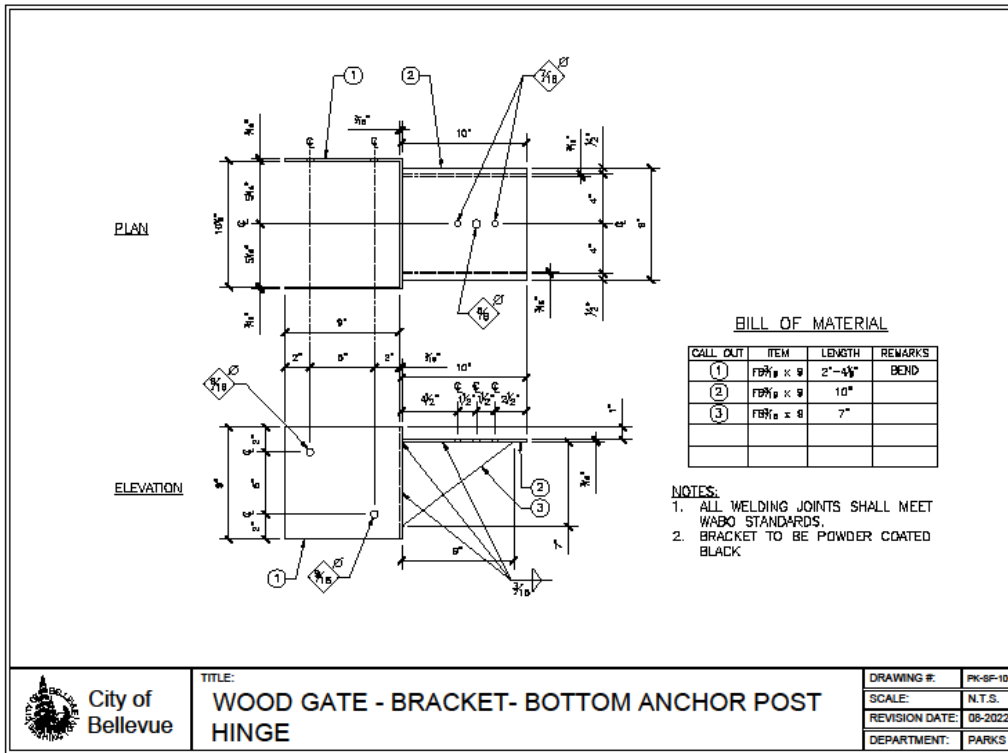

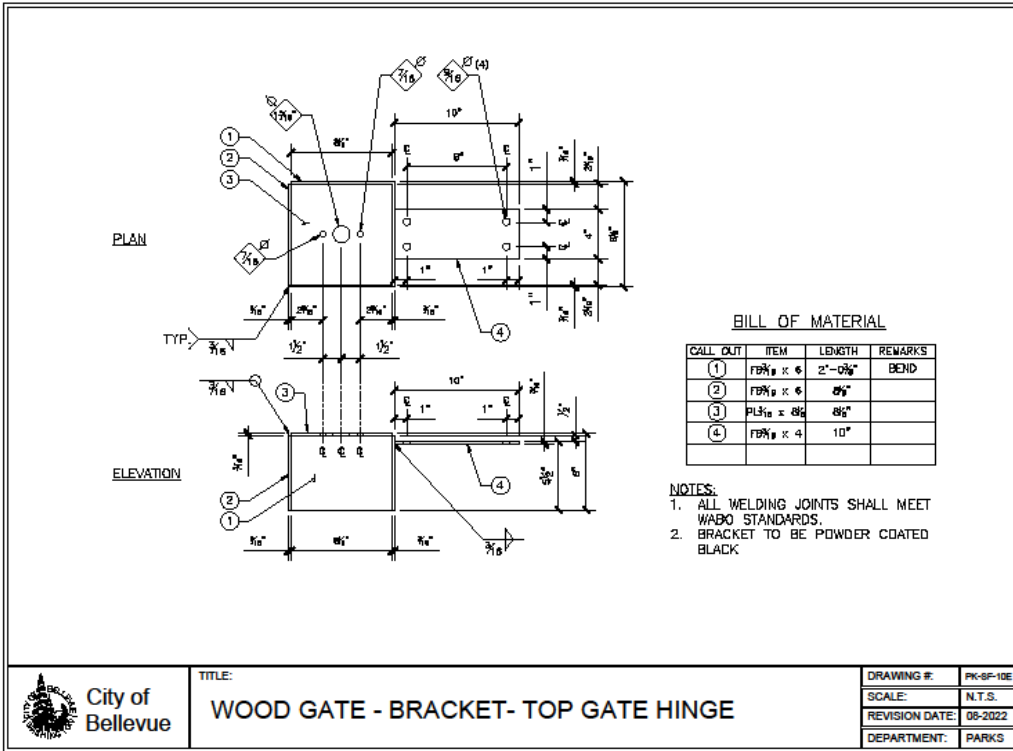



 **City of Bellevue**

TITLE: **WOOD GATE - BRACKET- TOP GATE HINGE**

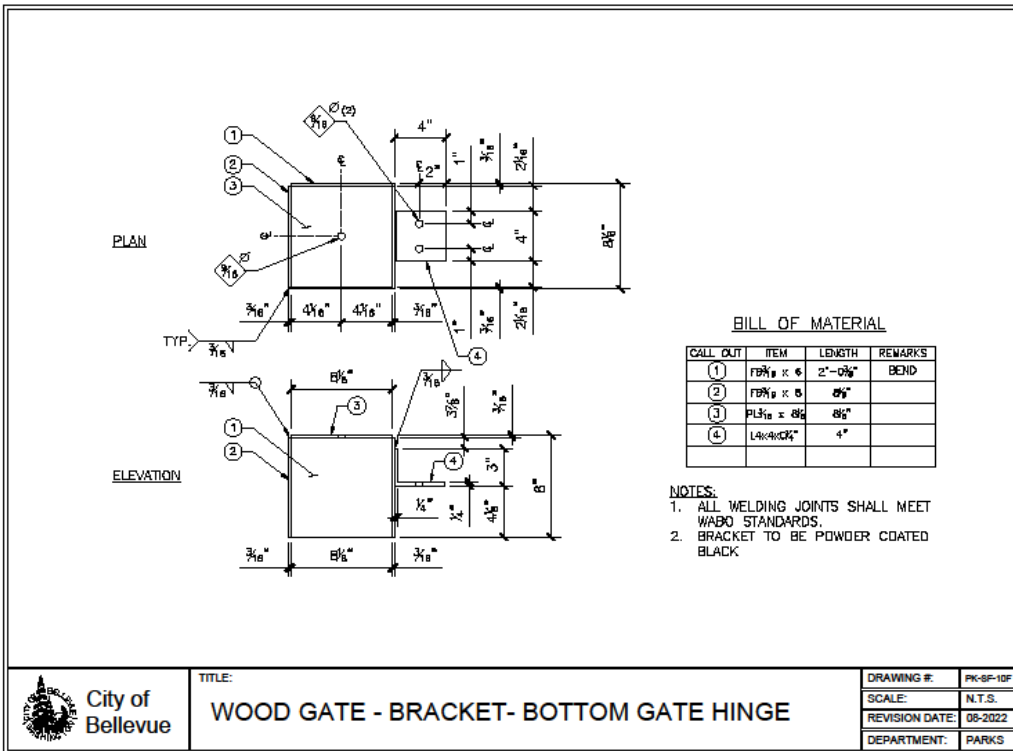
DRAWING #: PK-SF-10E  
 SCALE: N.T.S.  
 REVISION DATE: 06-2022  
 DEPARTMENT: PARKS



 **City of Bellevue**

TITLE: **WOOD GATE - BRACKET- BOTTOM GATE HINGE**

DRAWING #: PK-SF-10F  
 SCALE: N.T.S.  
 REVISION DATE: 06-2022  
 DEPARTMENT: PARKS

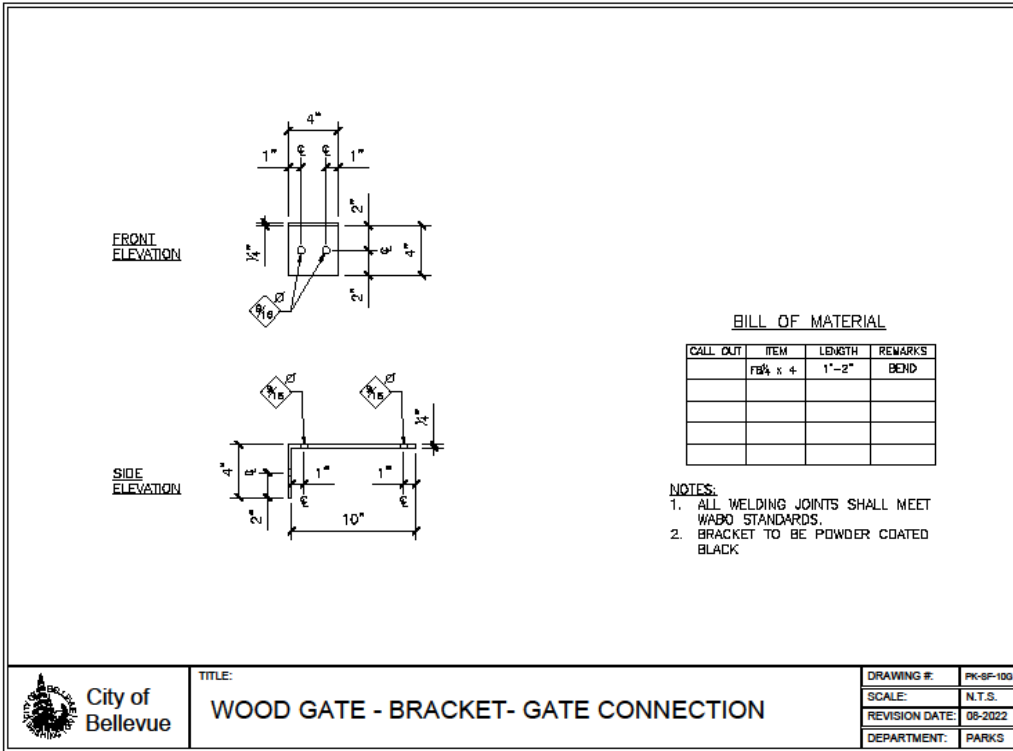

City of Bellevue

TITLE: **WOOD GATE - BRACKET- GATE CONNECTION**

DRAWING #:	PK-SF-100
SCALE:	N.T.S.
REVISION DATE:	08-2022
DEPARTMENT:	PARKS

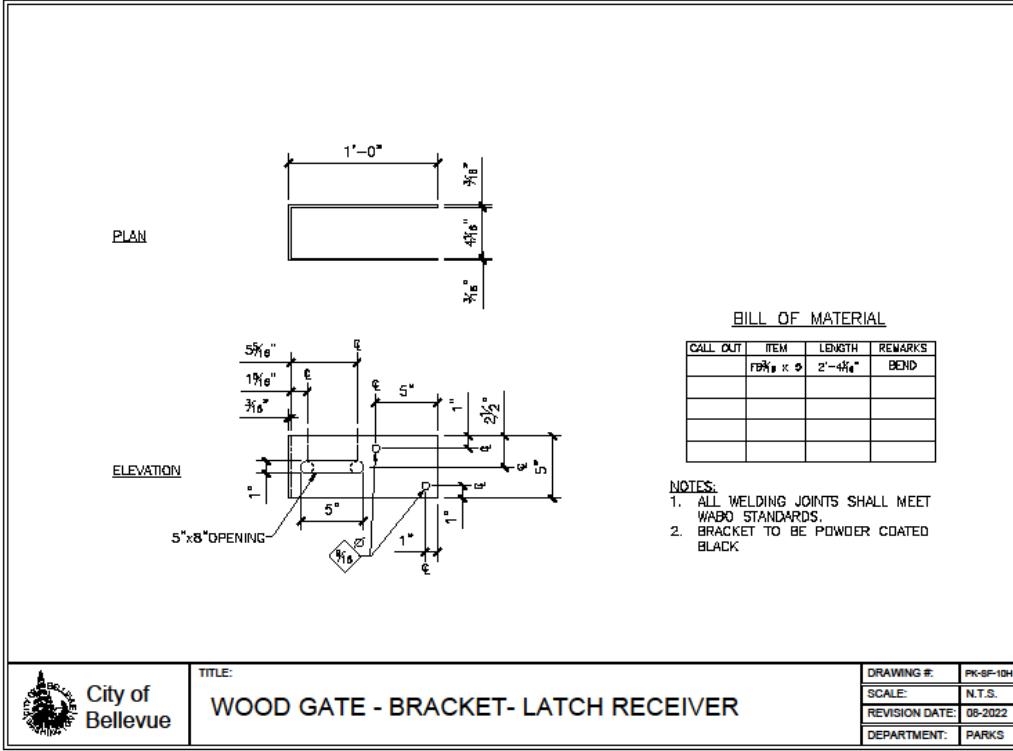

City of Bellevue

TITLE: **WOOD GATE - BRACKET- LATCH RECEIVER**

DRAWING #:	PK-SF-104
SCALE:	N.T.S.
REVISION DATE:	08-2022
DEPARTMENT:	PARKS

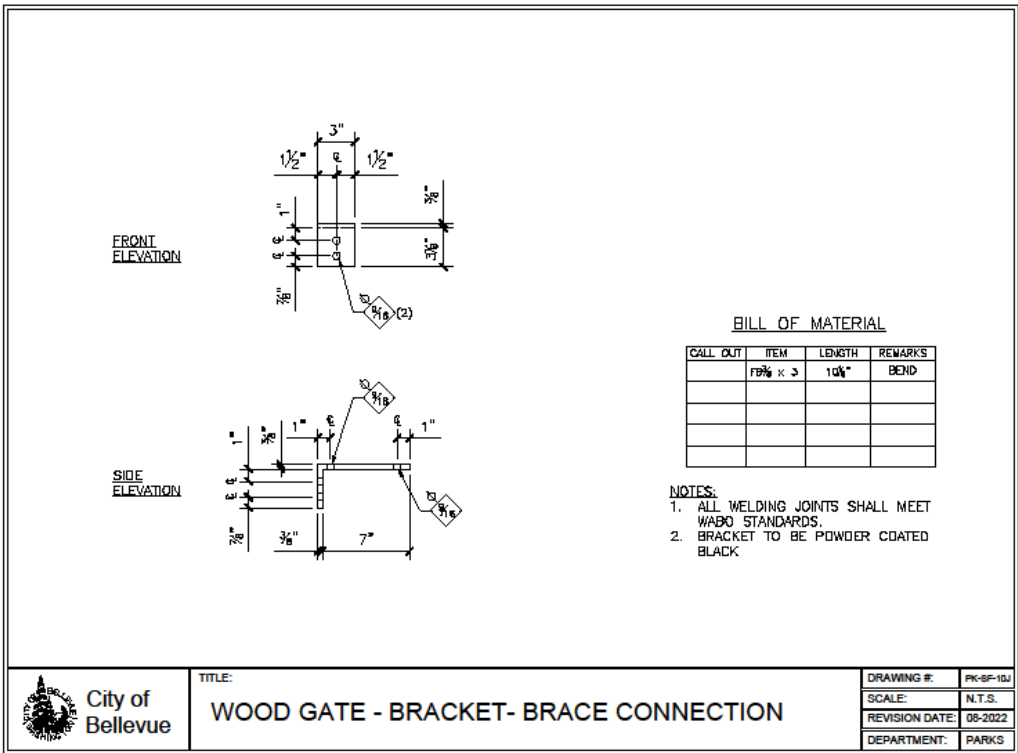
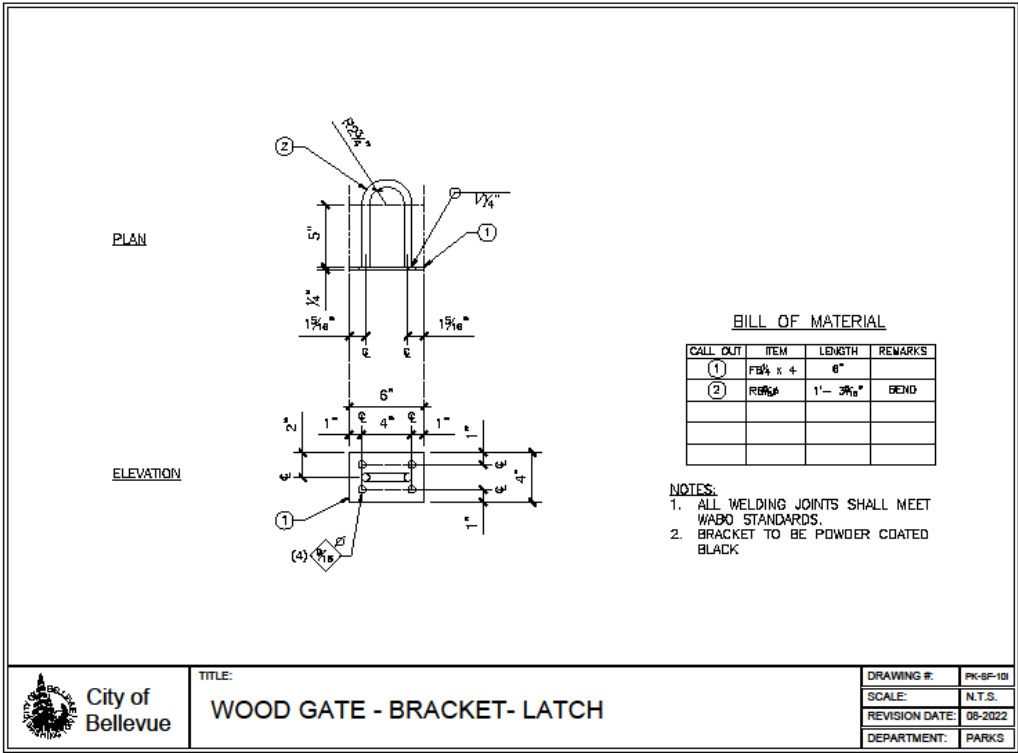



(This page intentionally left blank)

## Hard Surfaces

---



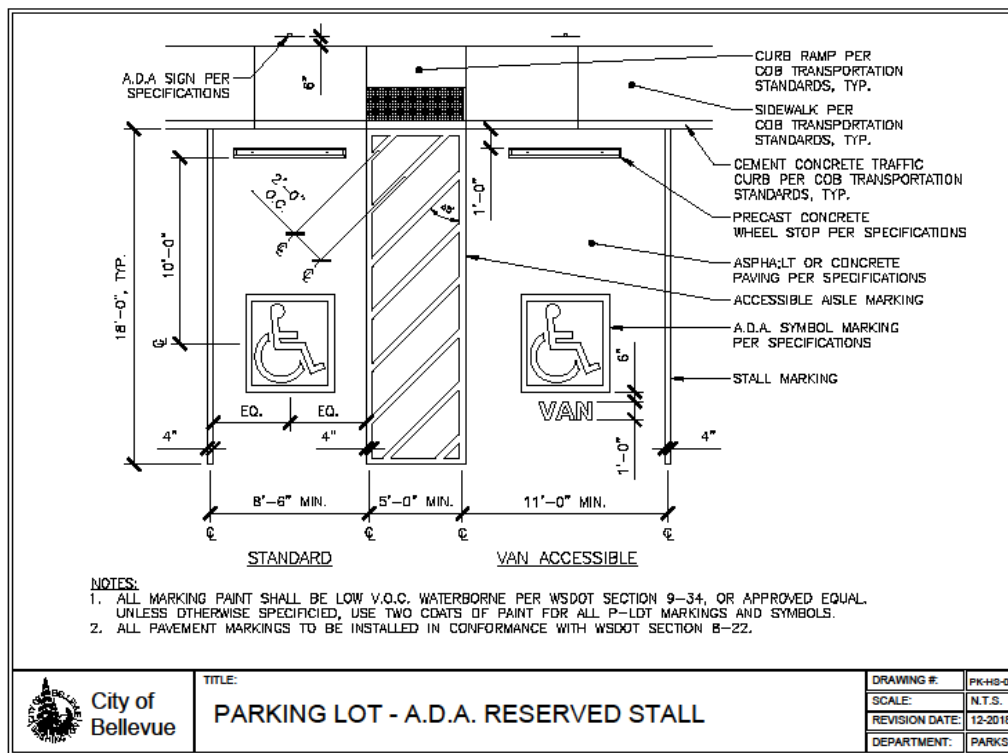
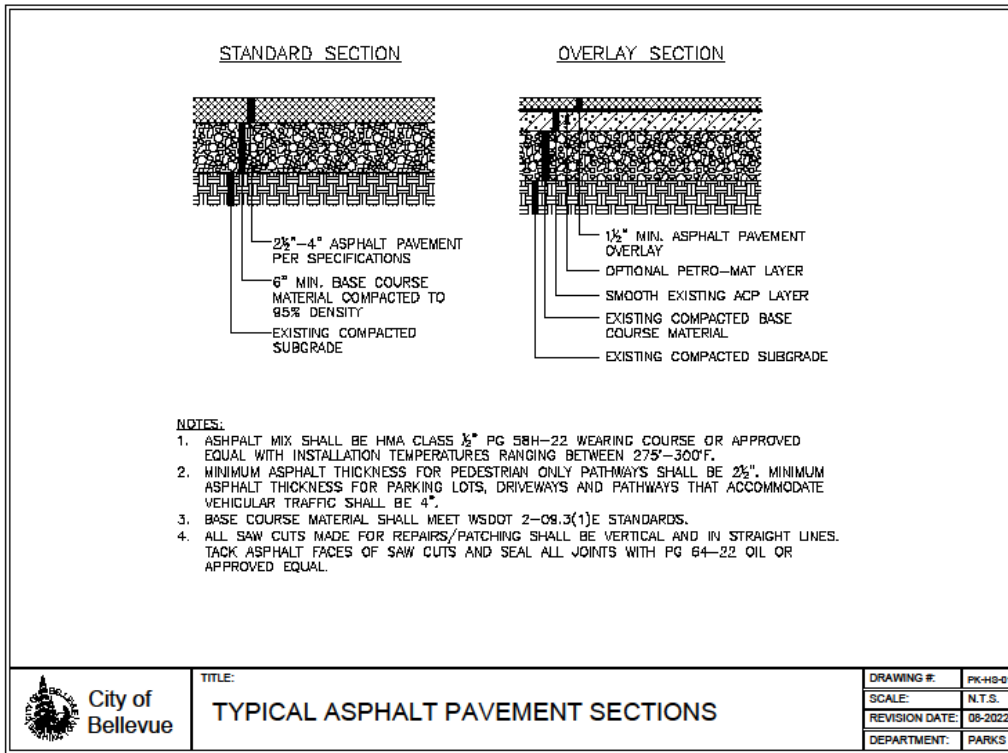

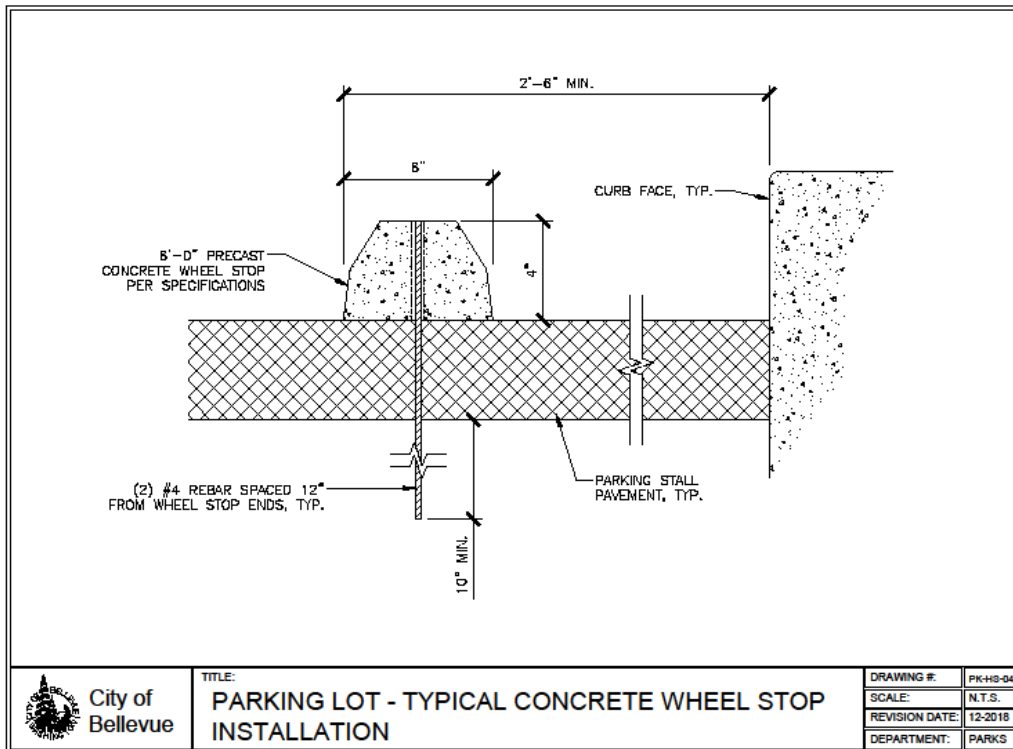
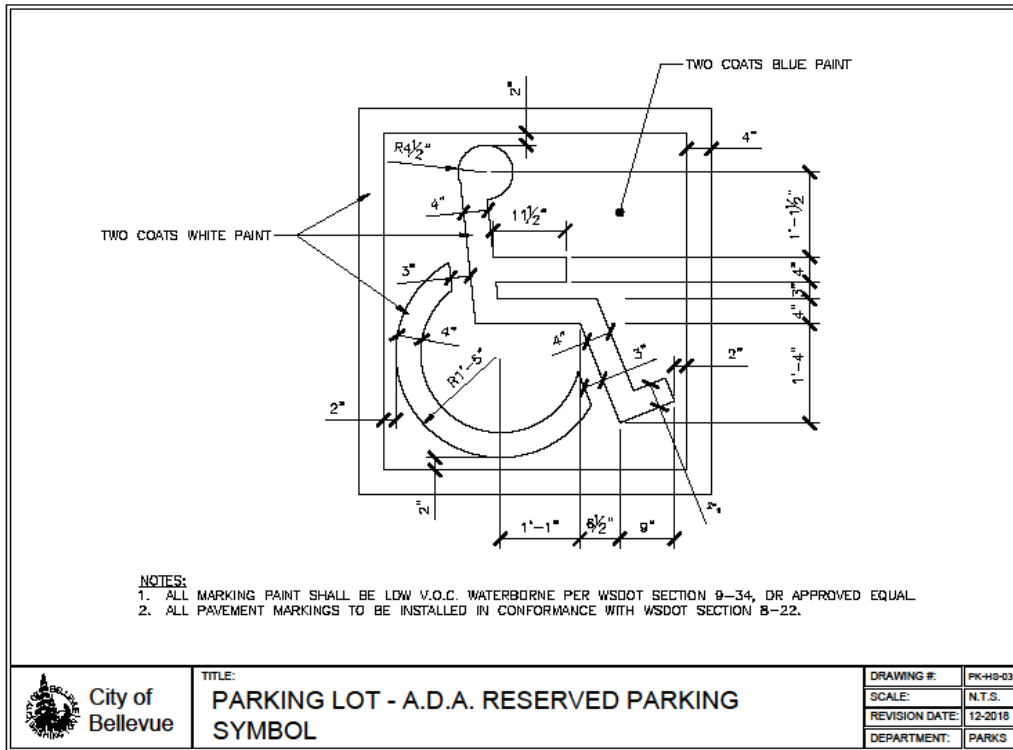

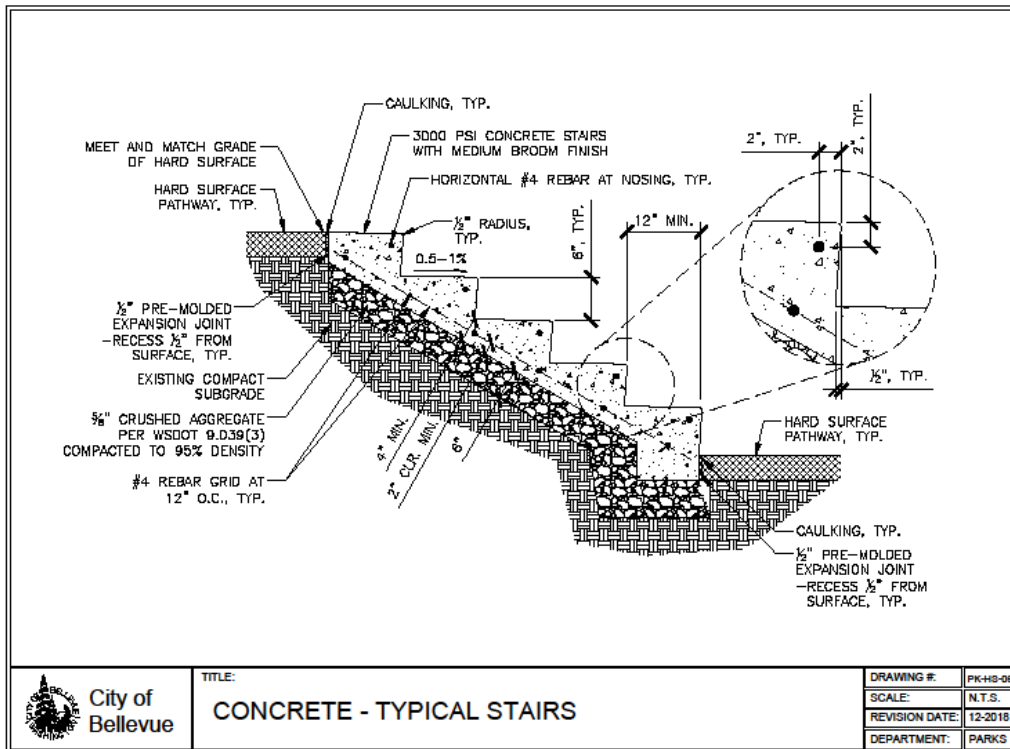
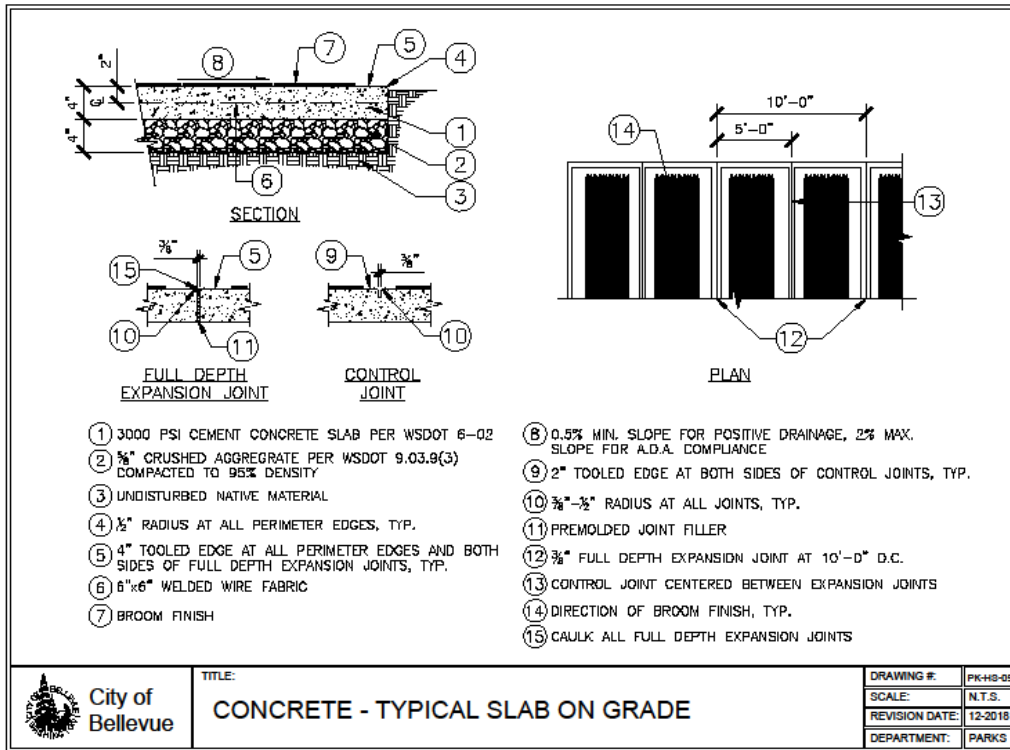

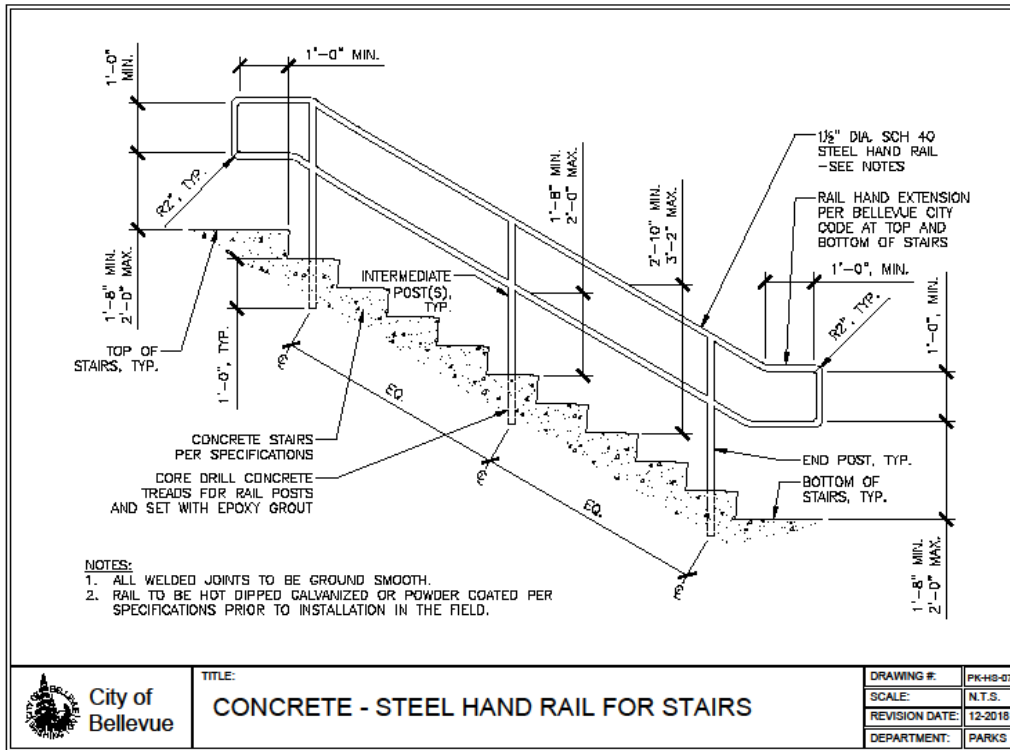

City of Bellevue

TITLE: **CONCRETE - STEEL HAND RAIL FOR STAIRS**

DRAWING #:	PK-HS-07
SCALE:	N.T.S.
REVISION DATE:	12-2018
DEPARTMENT:	PARKS

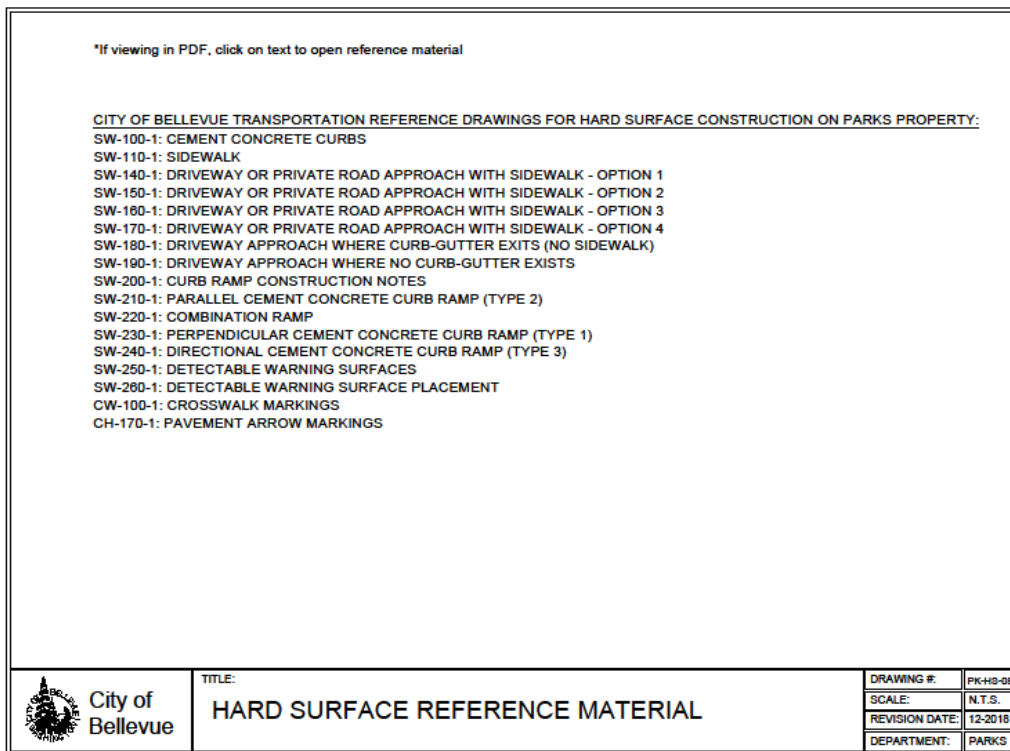

City of Bellevue

TITLE: **HARD SURFACE REFERENCE MATERIAL**

DRAWING #:	PK-HS-08
SCALE:	N.T.S.
REVISION DATE:	12-2018
DEPARTMENT:	PARKS

(This page intentionally left blank)

# Irrigation

---





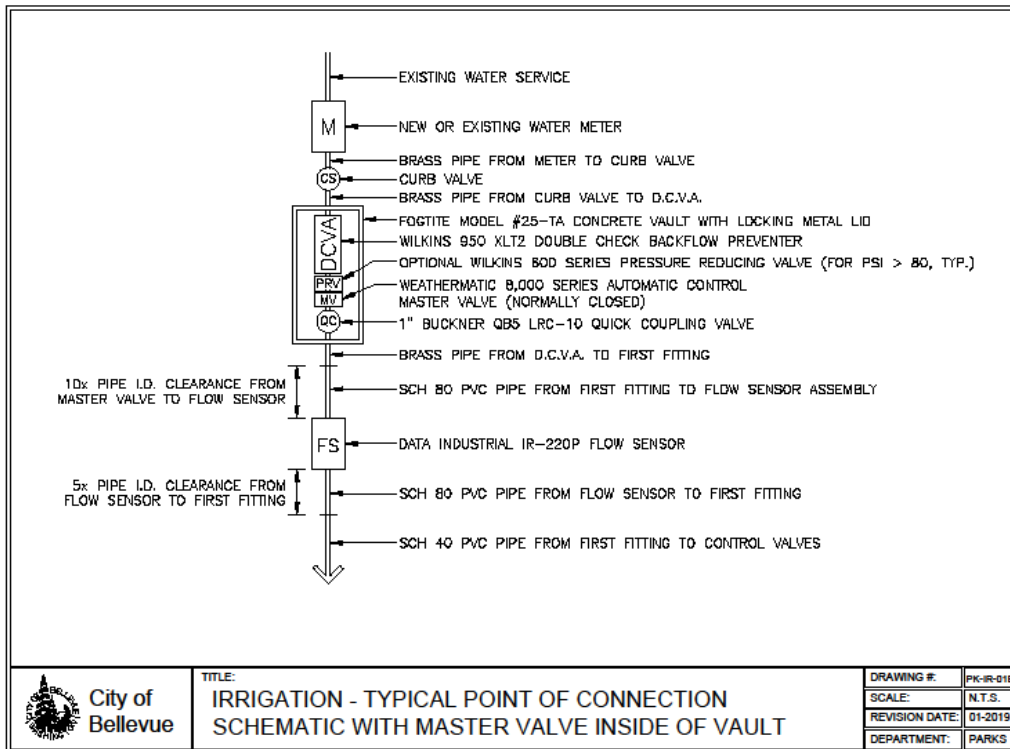
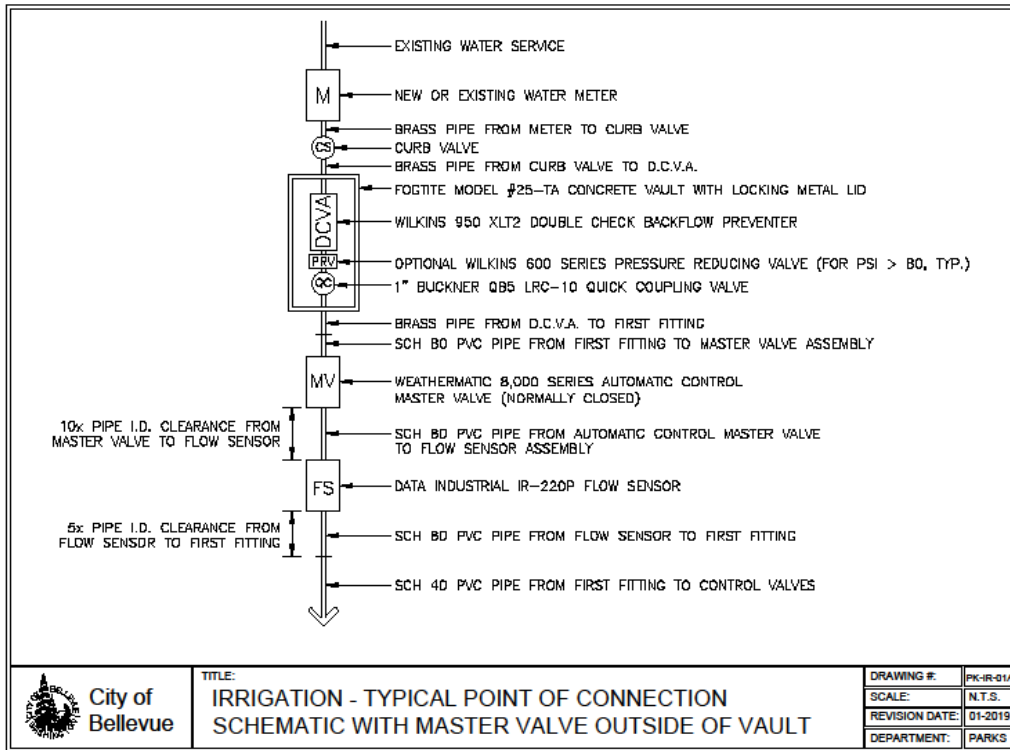

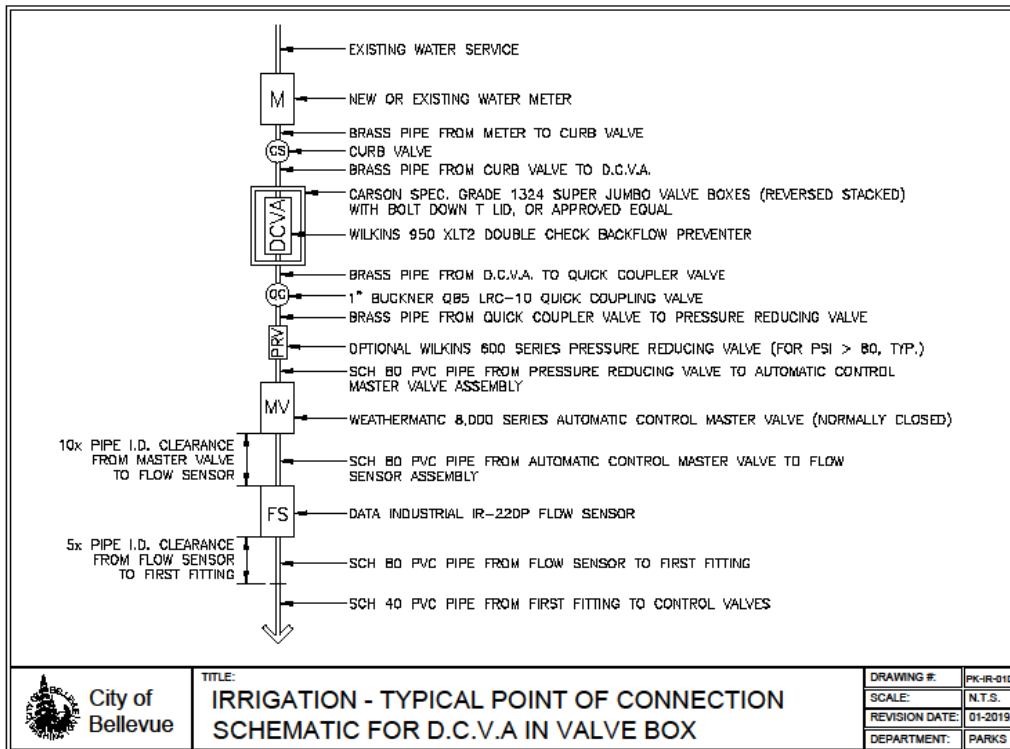
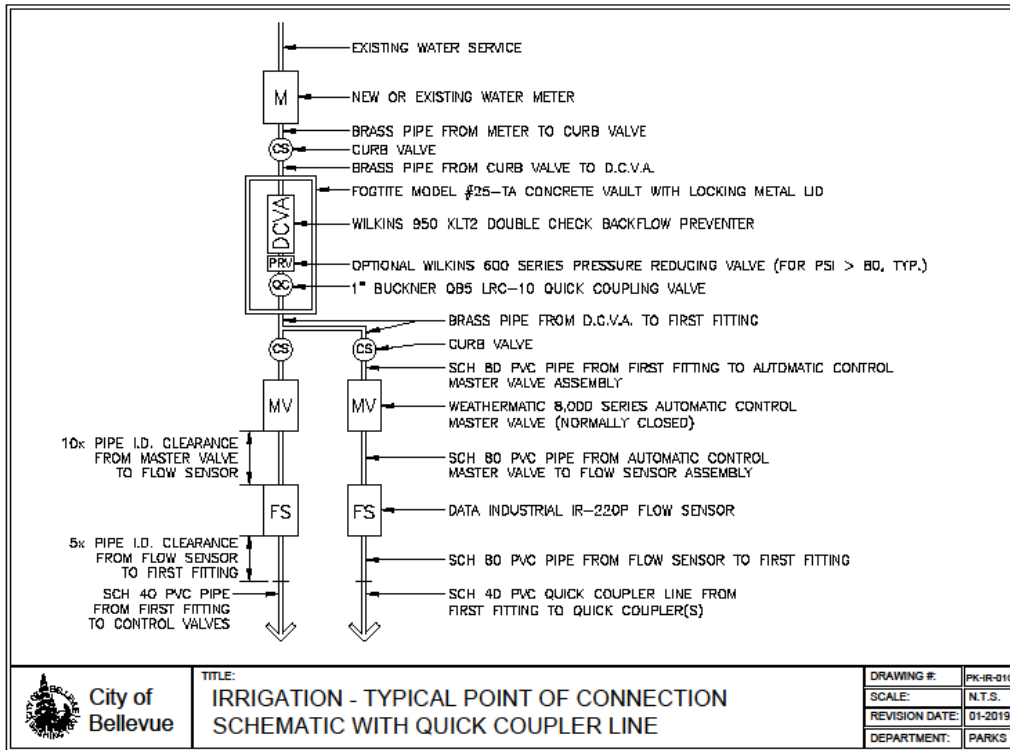

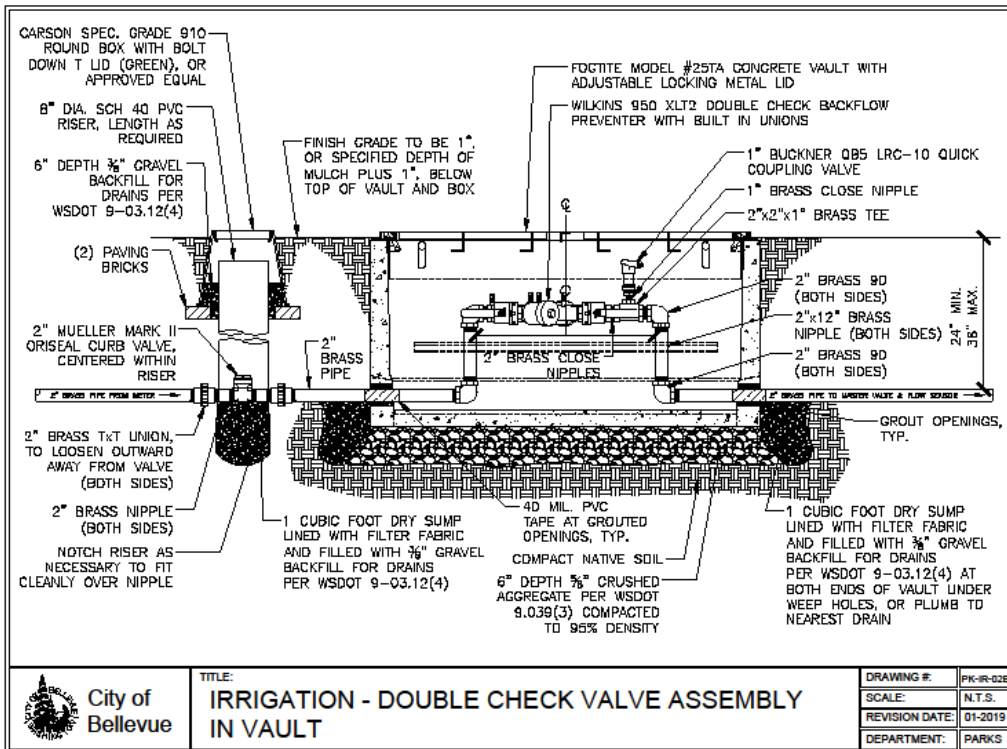
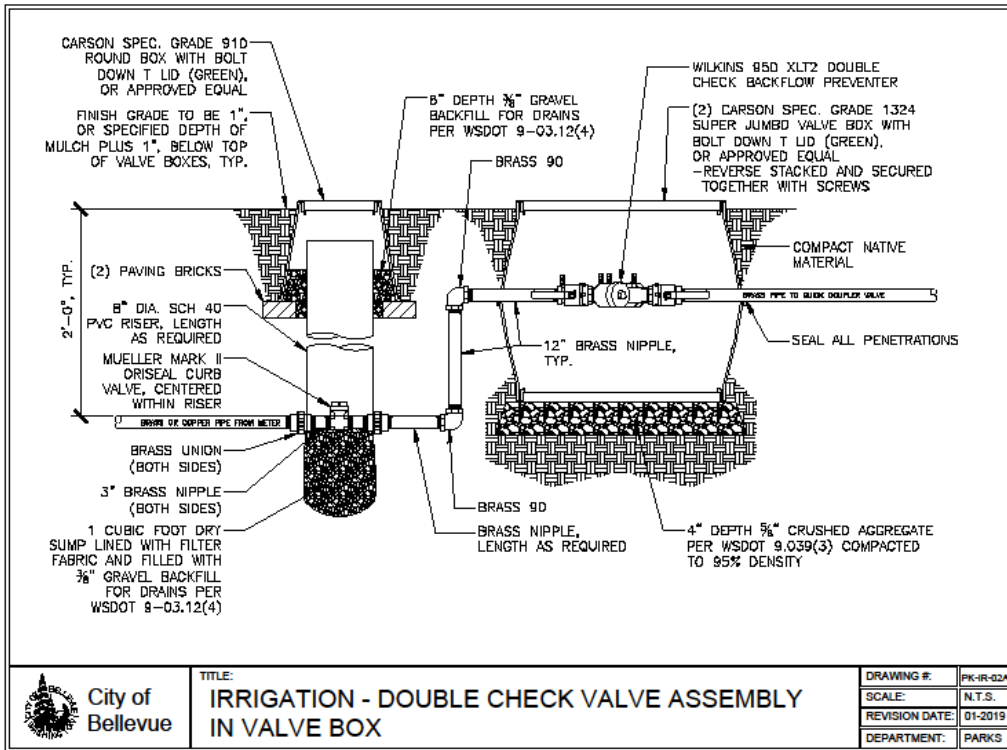

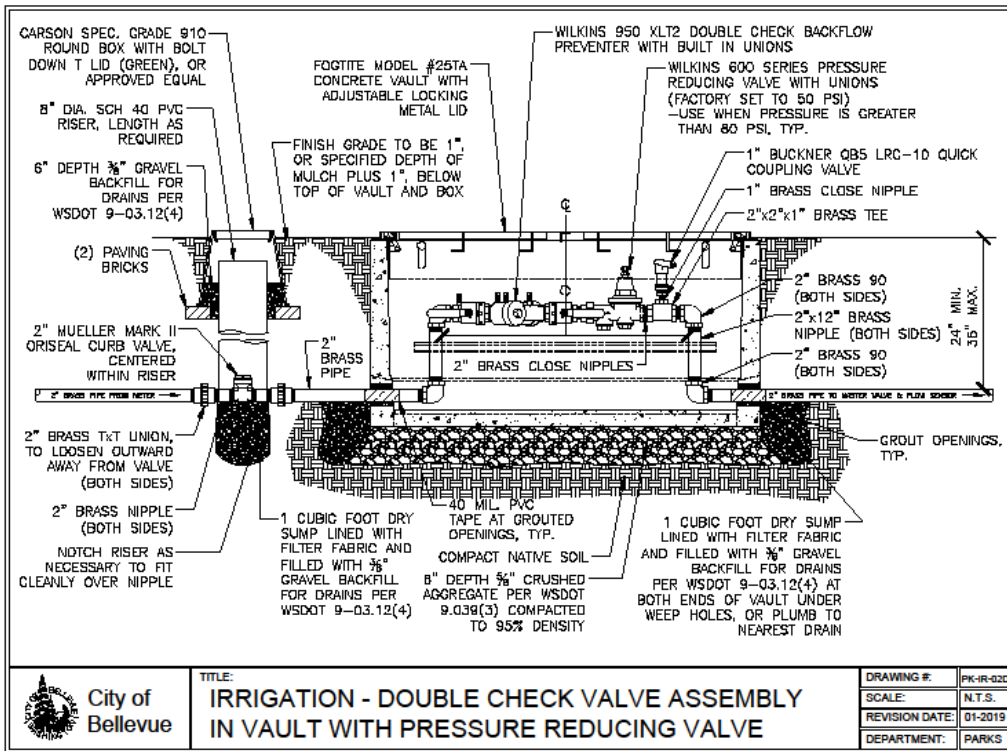
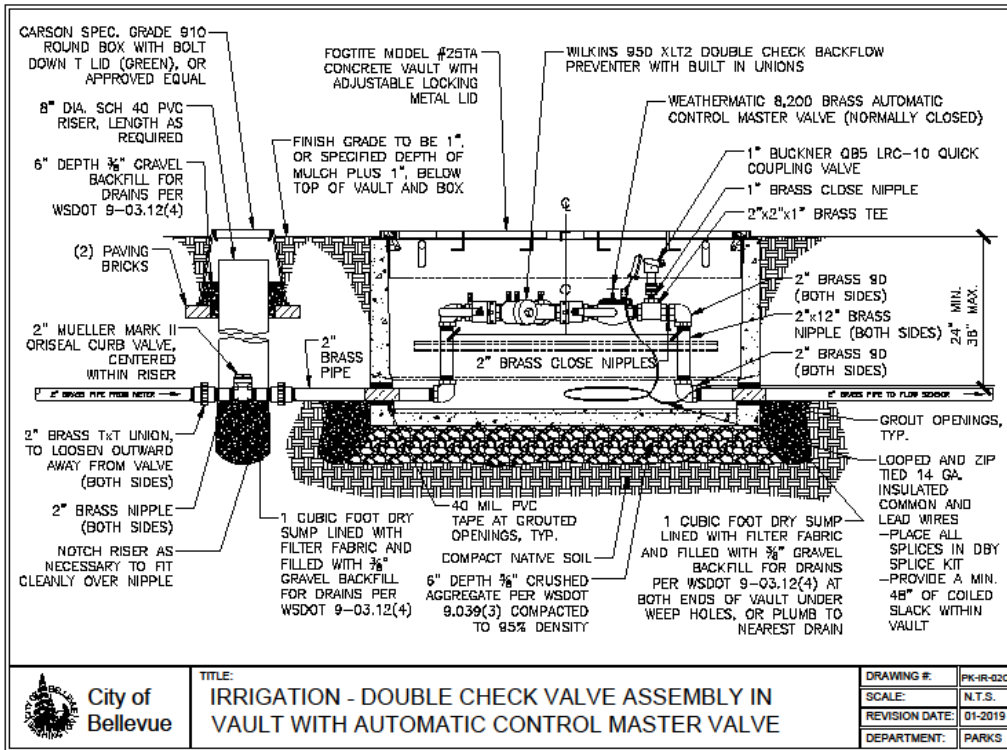

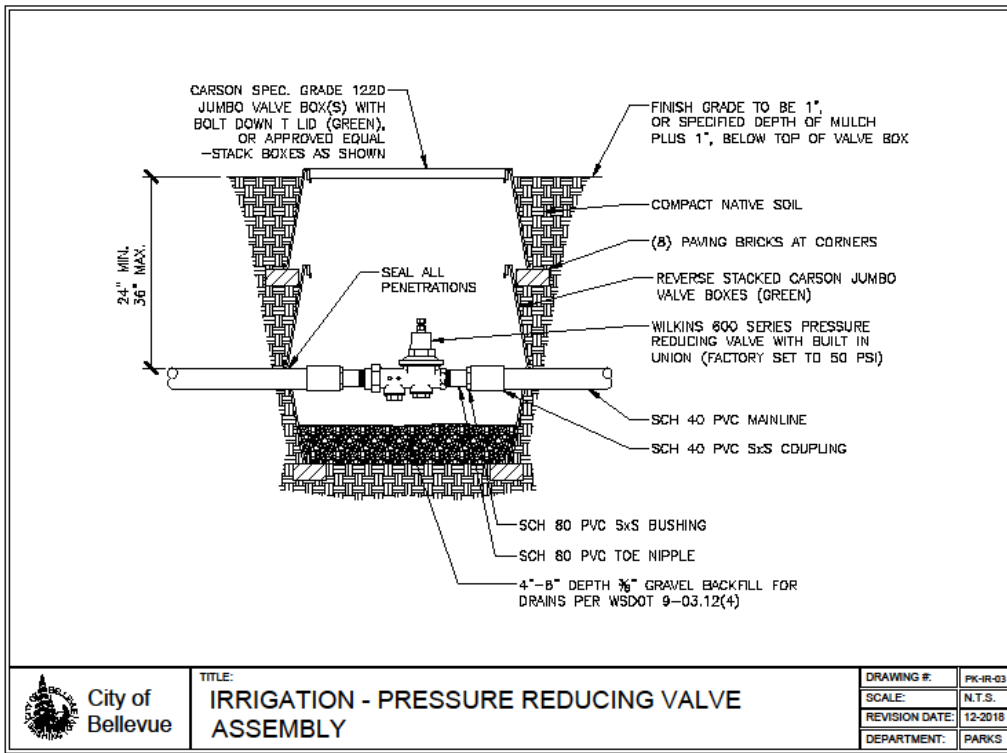
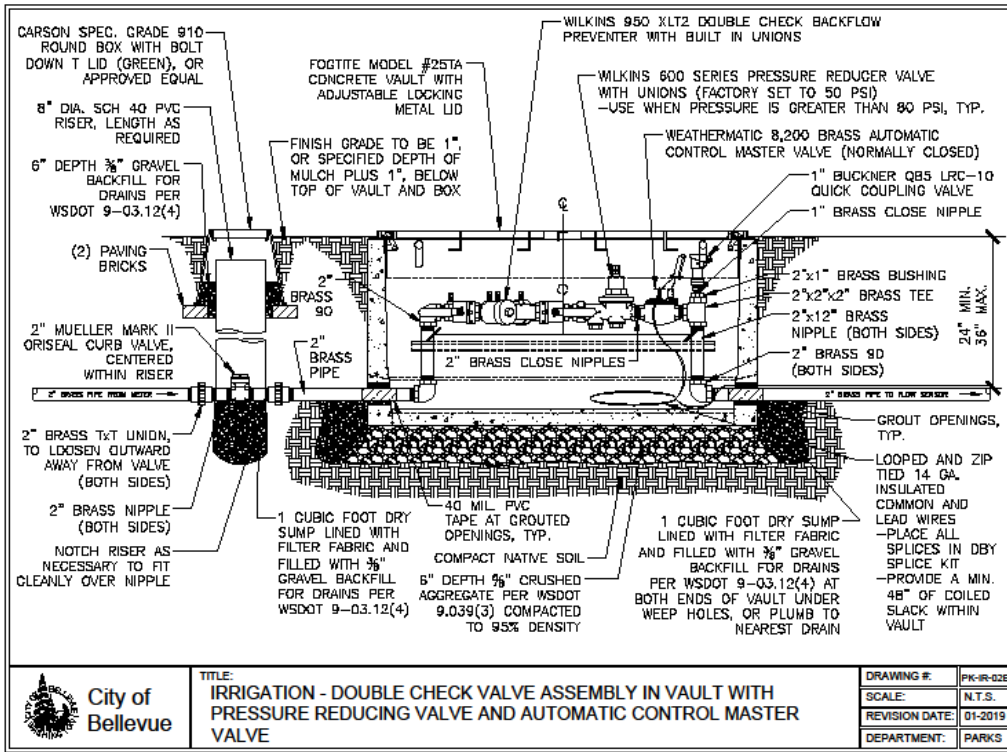

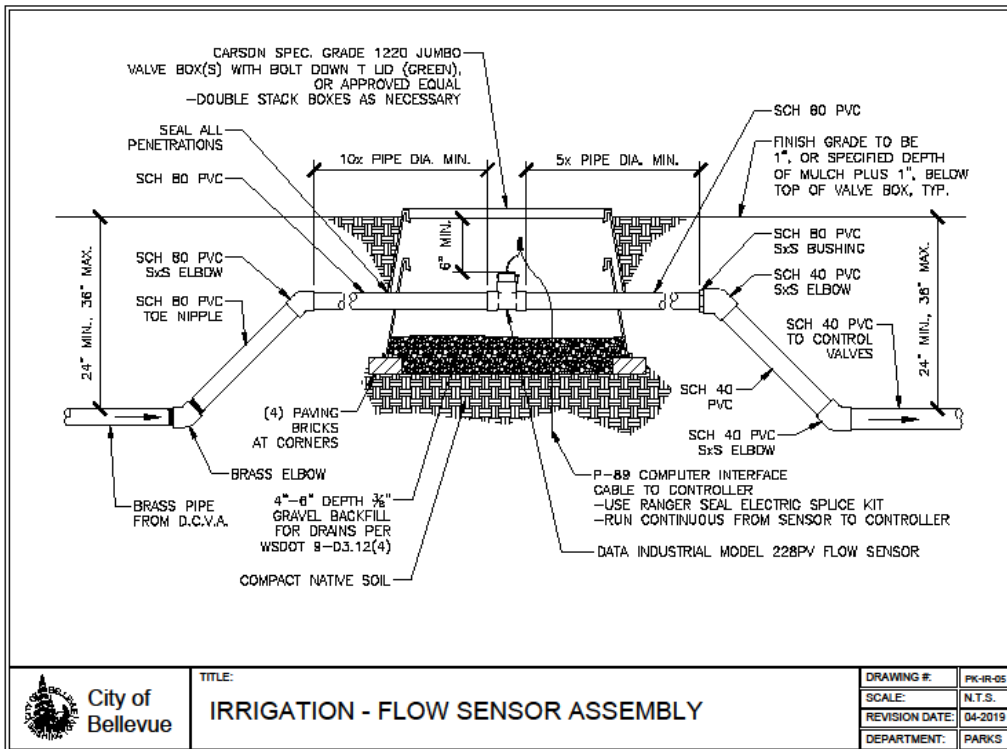
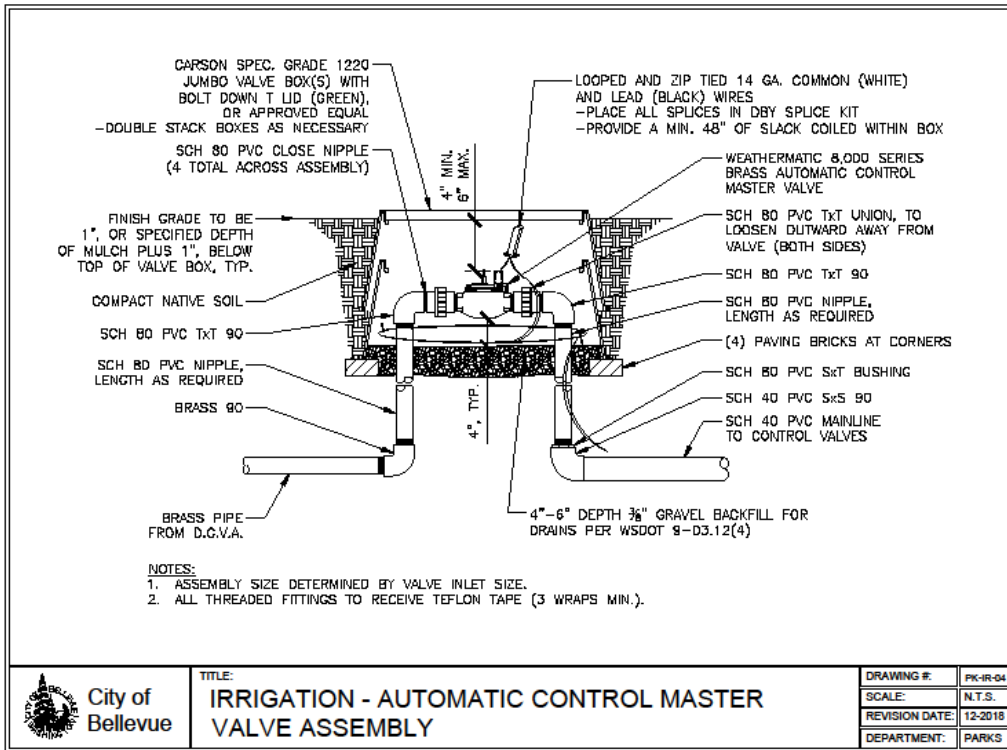

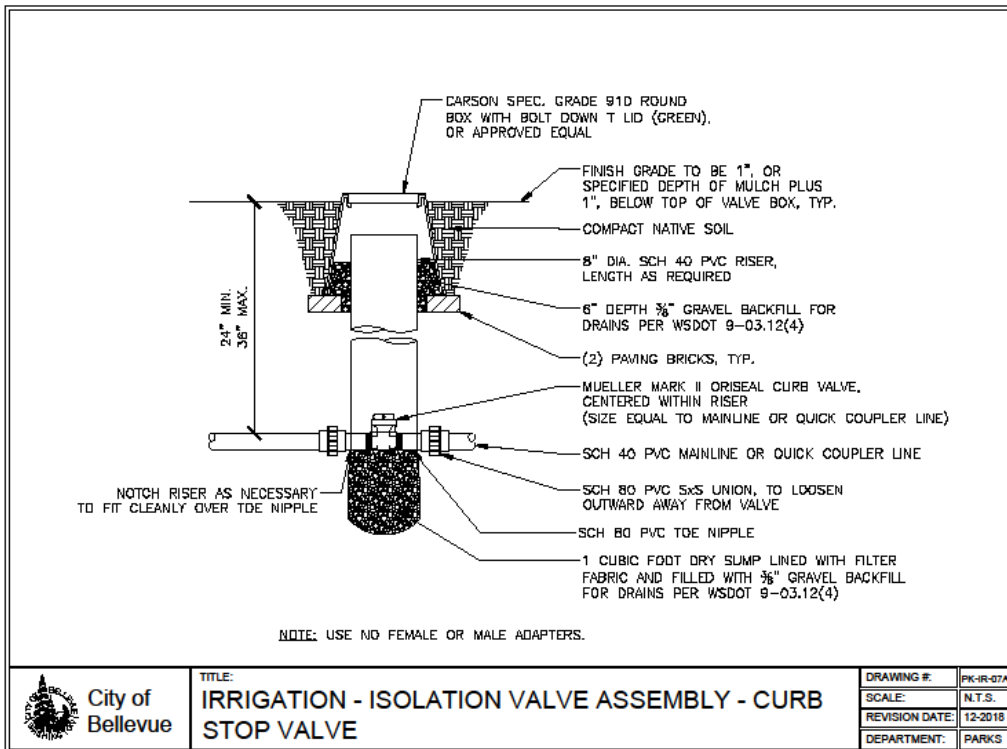
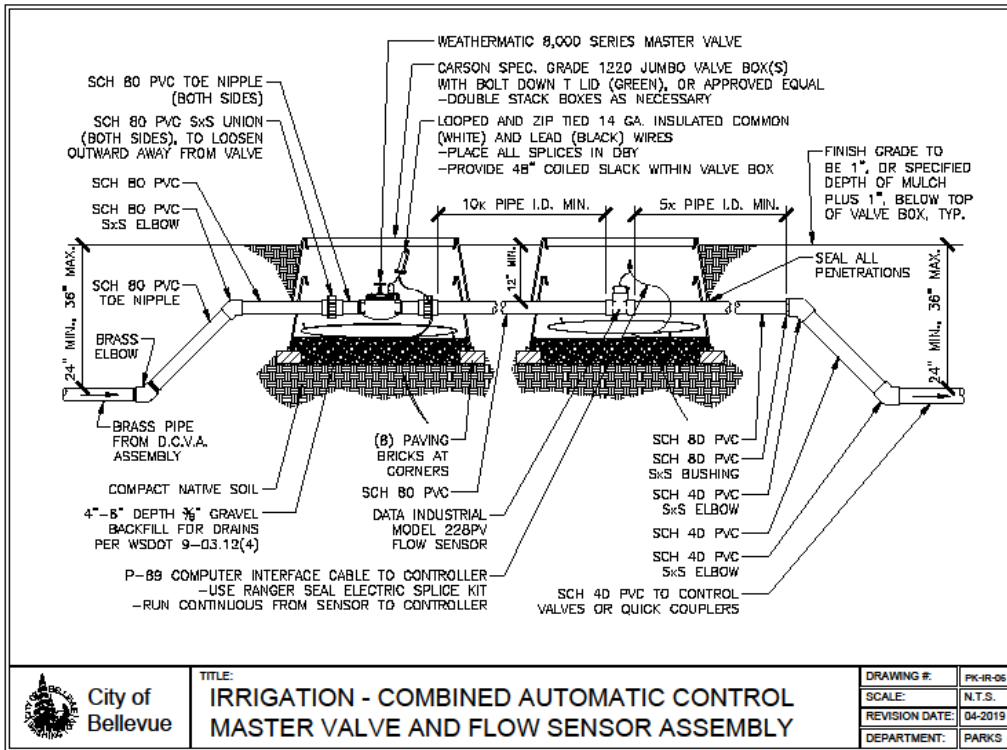

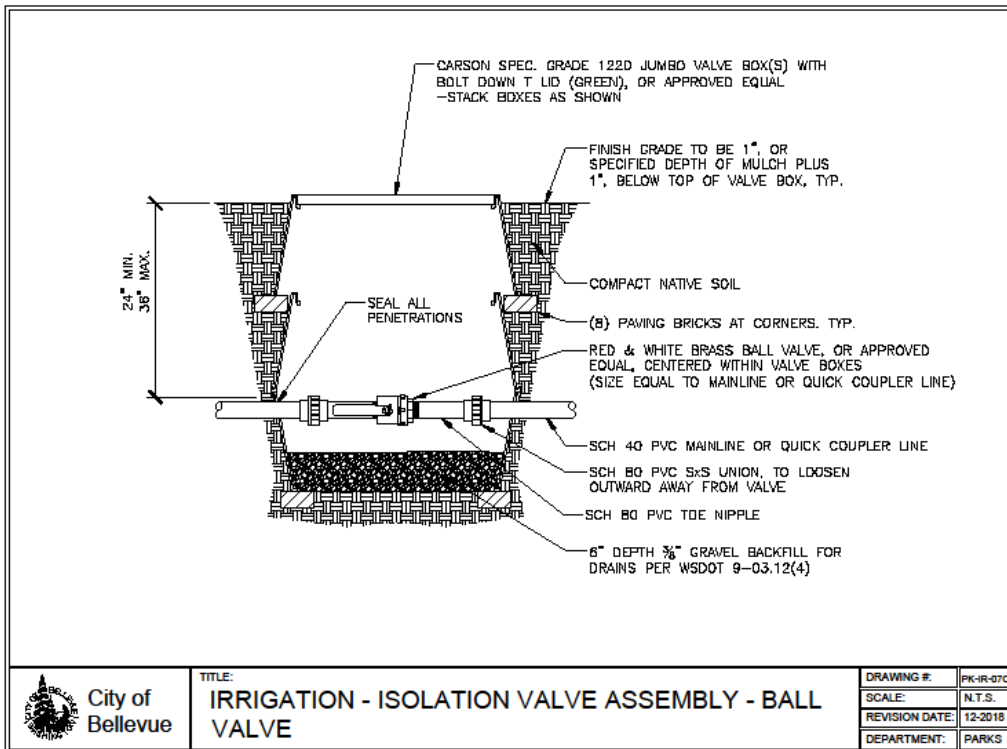
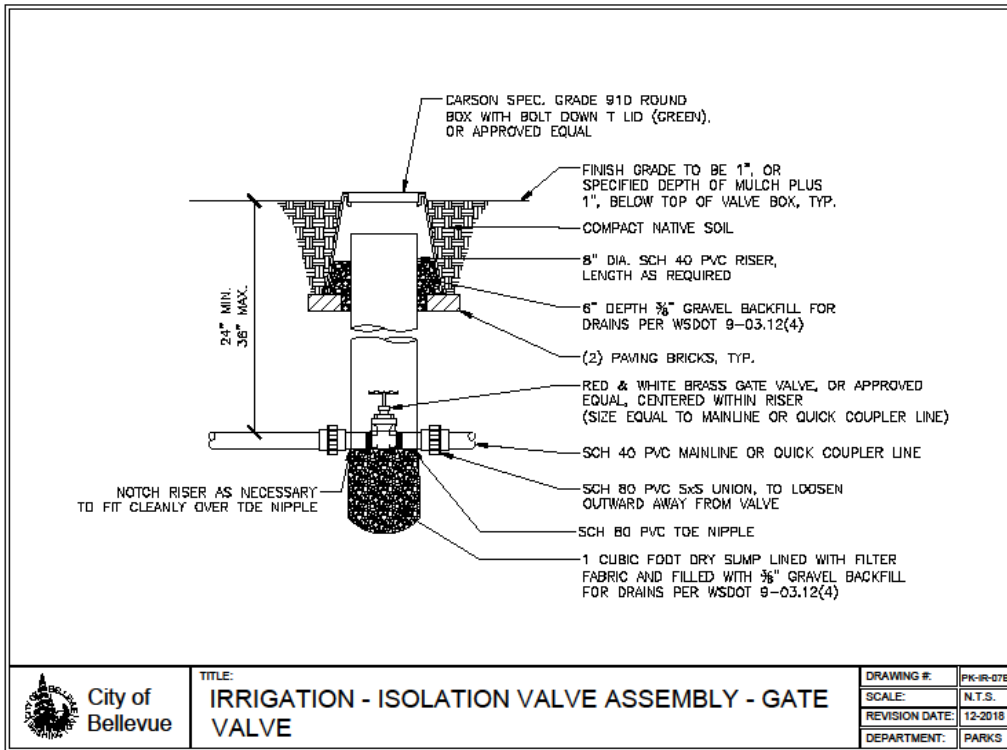



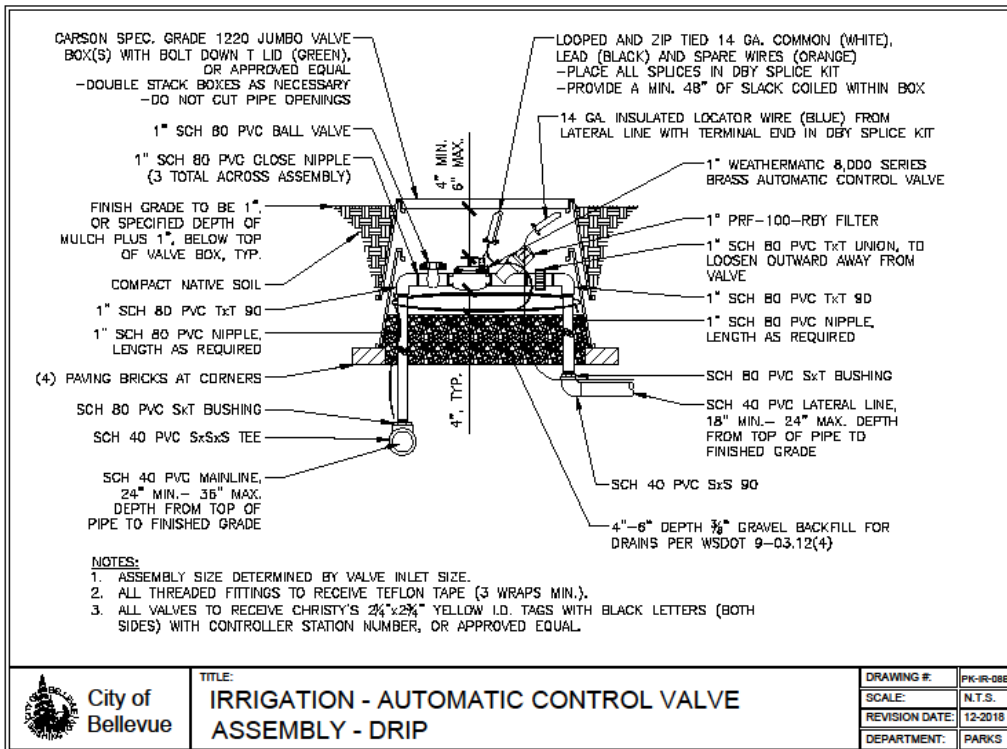
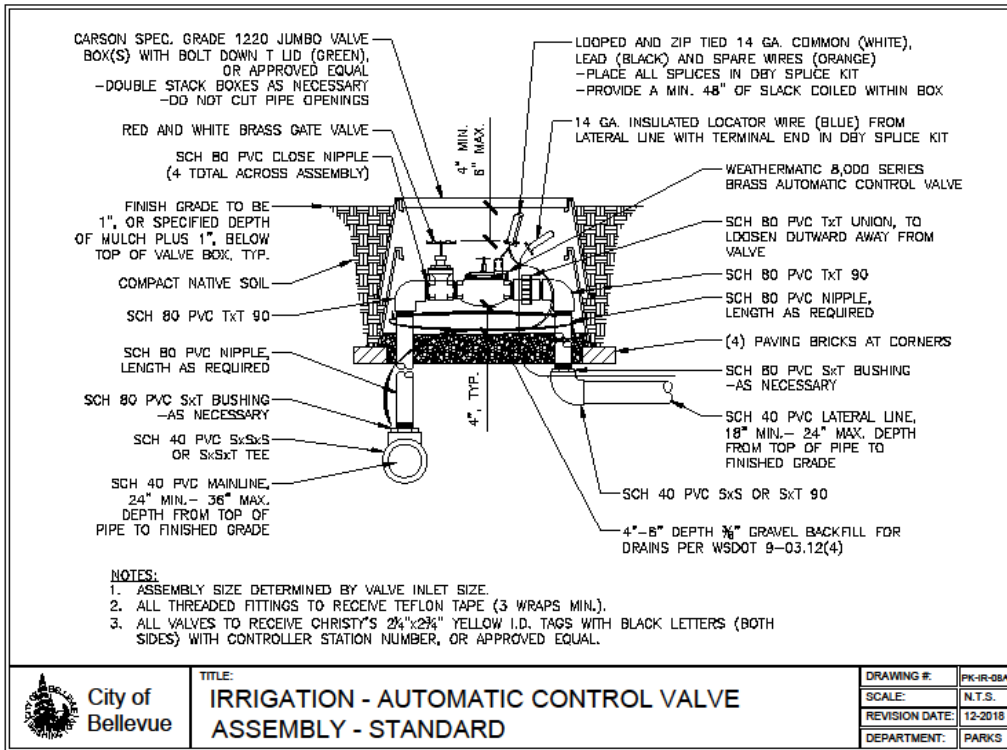

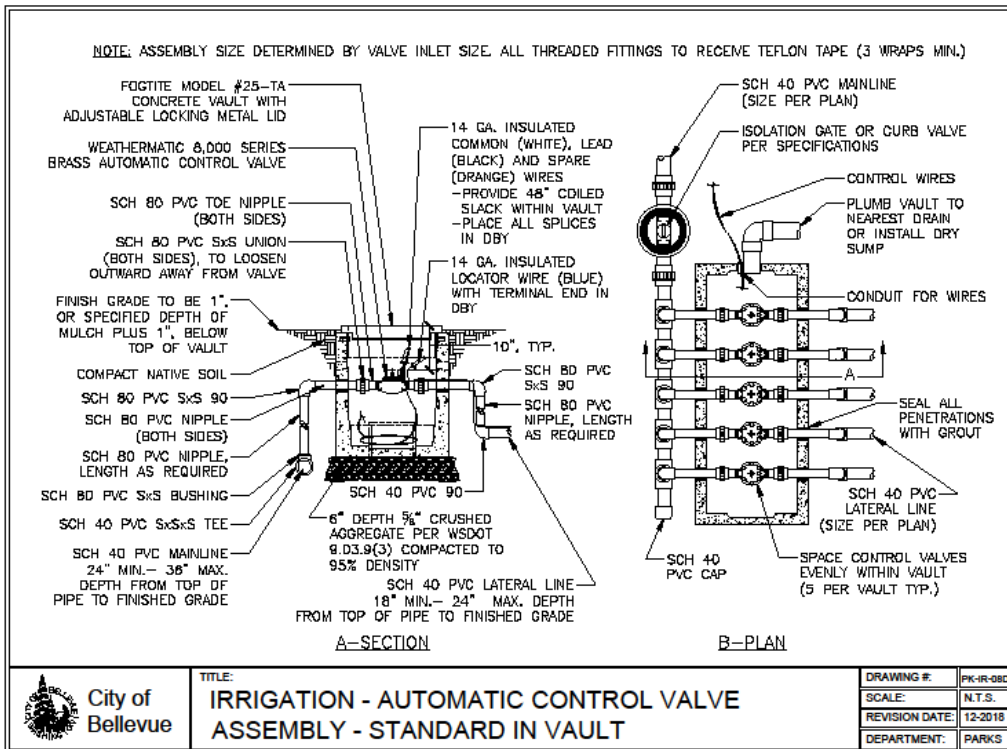
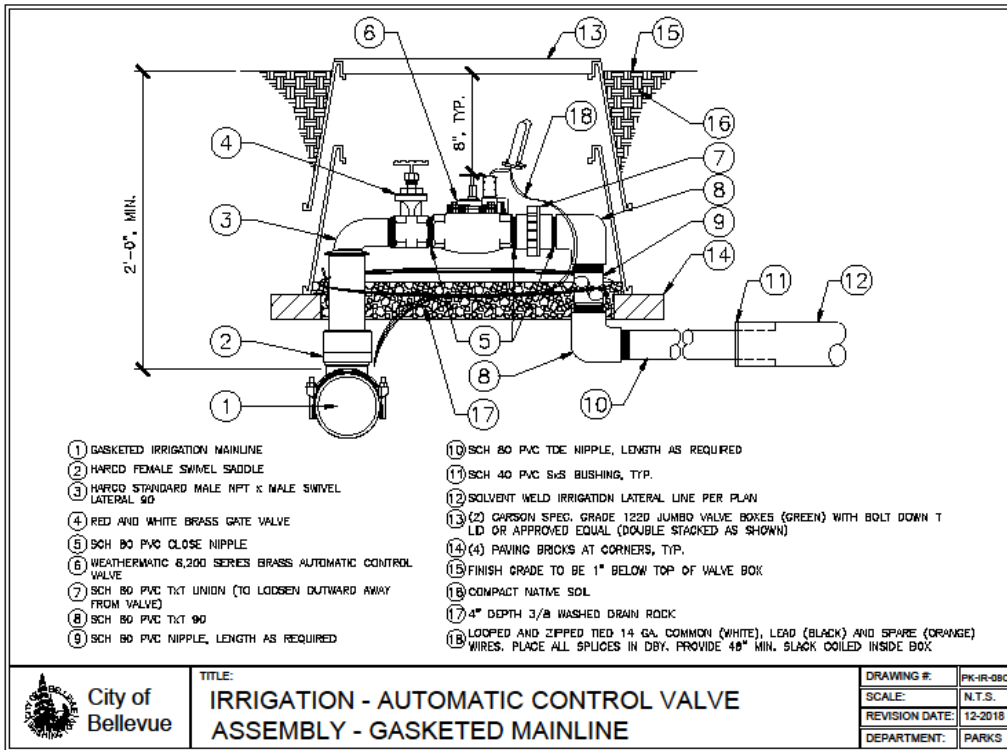

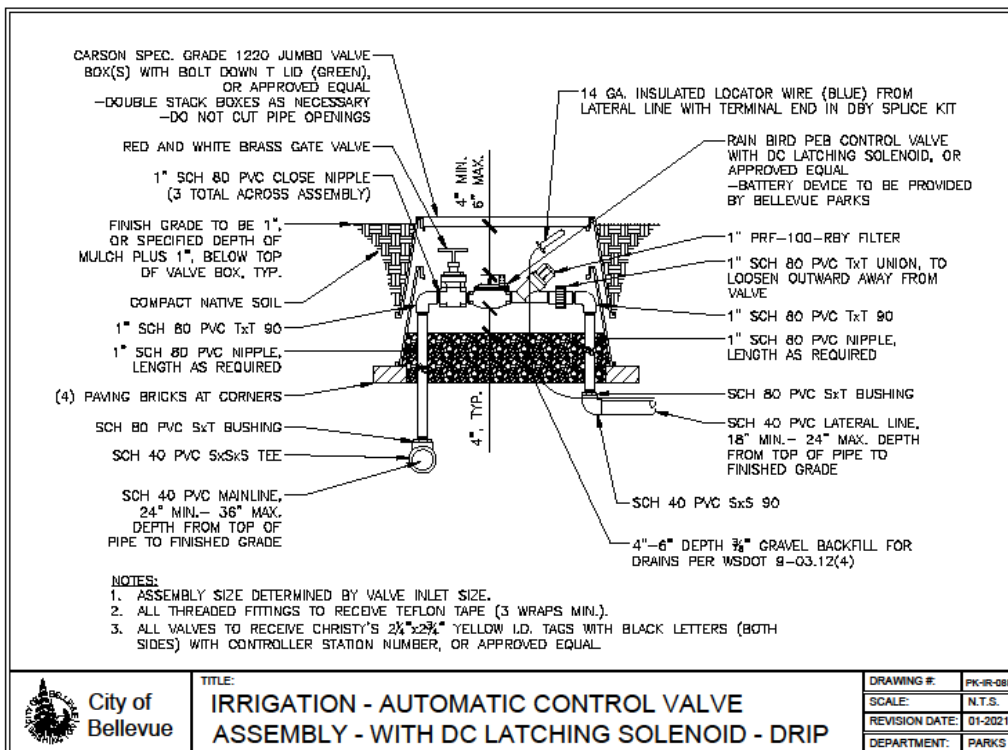
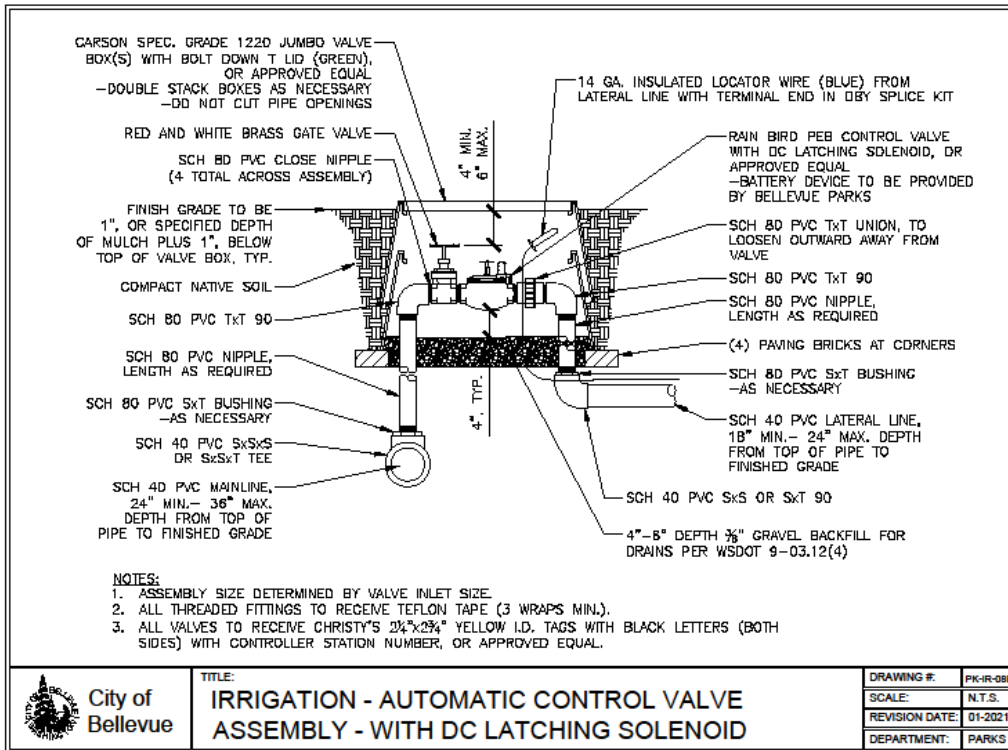

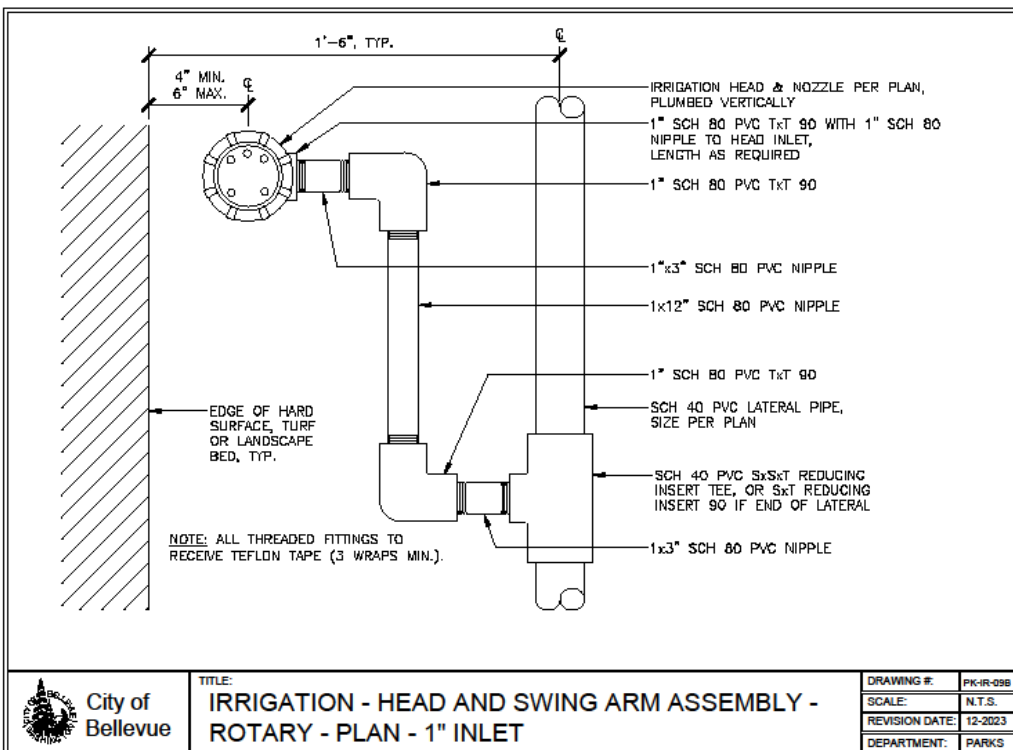
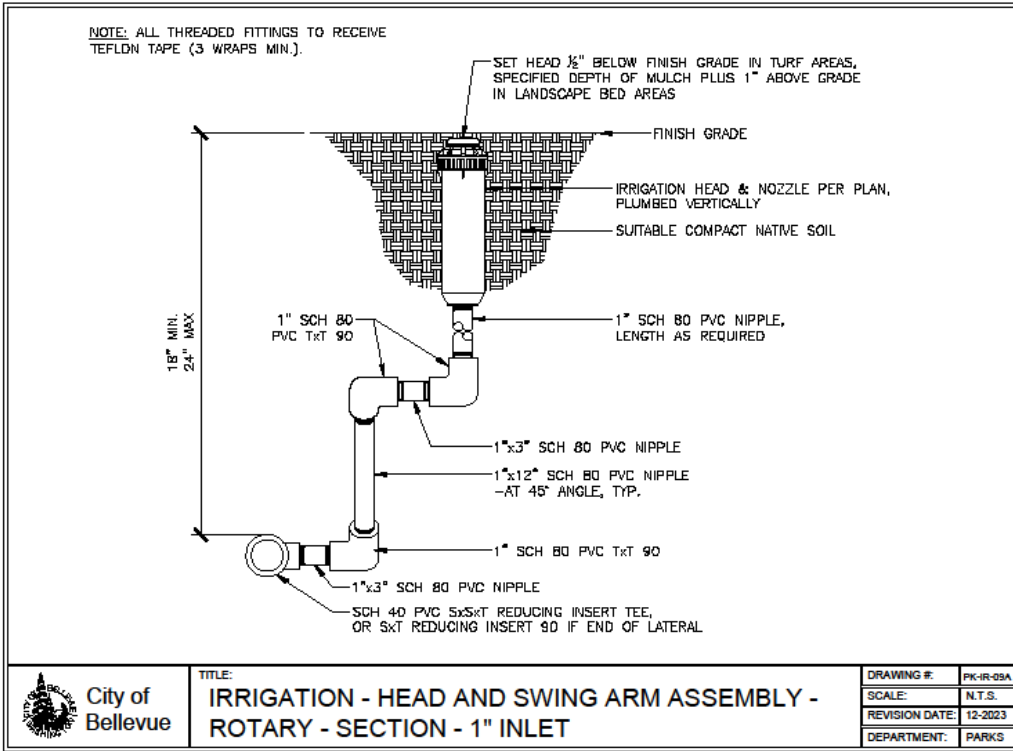

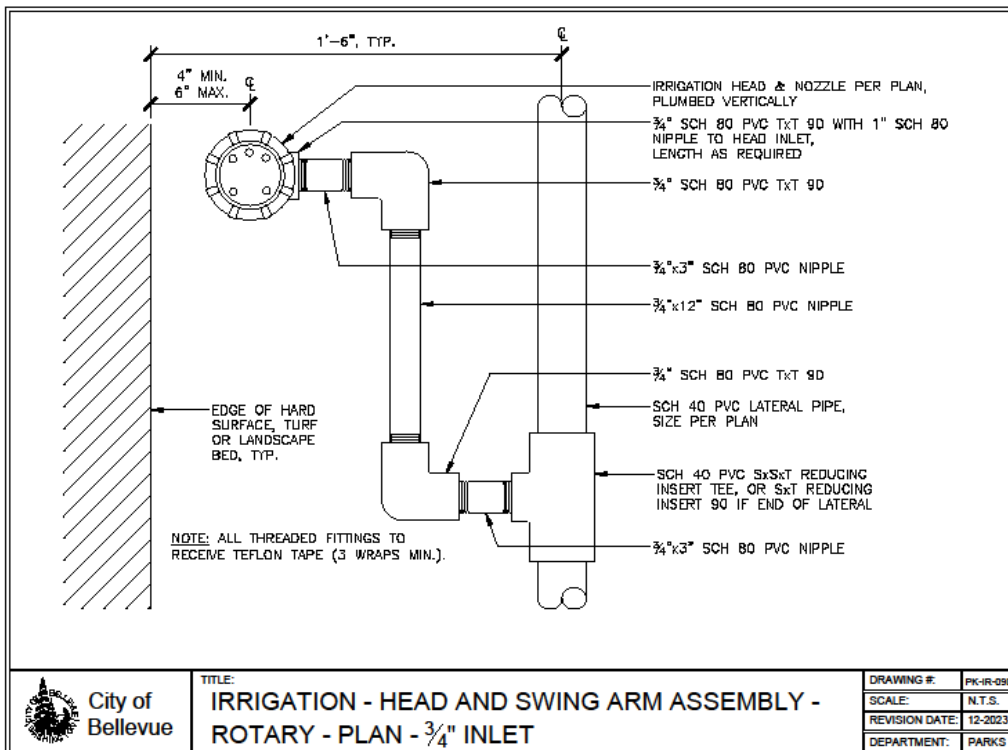
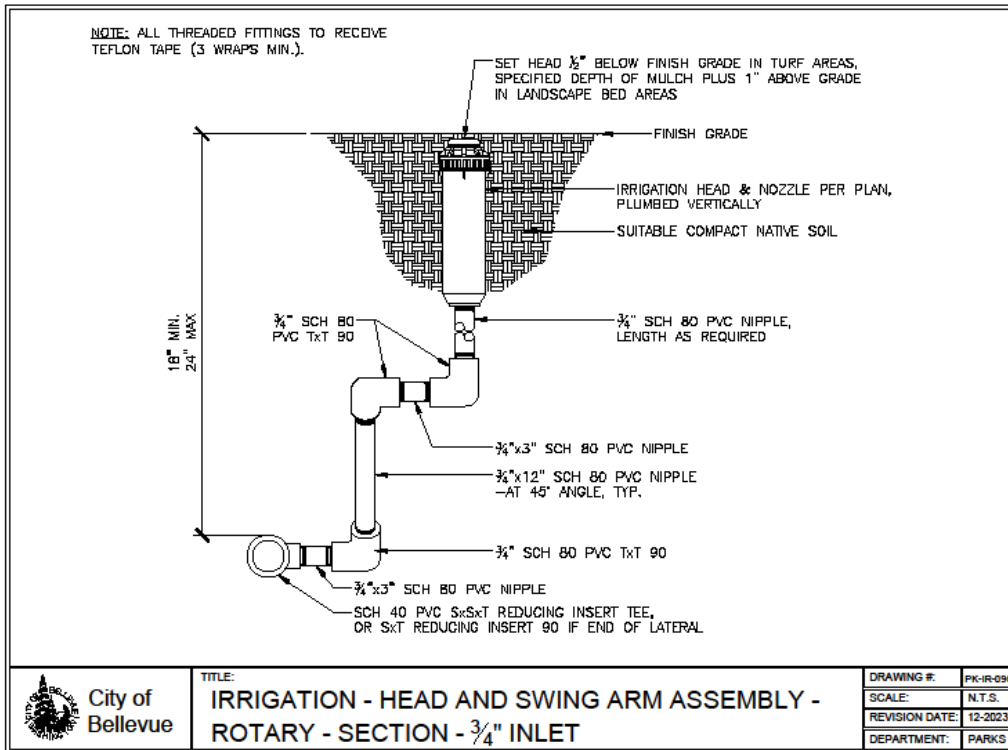

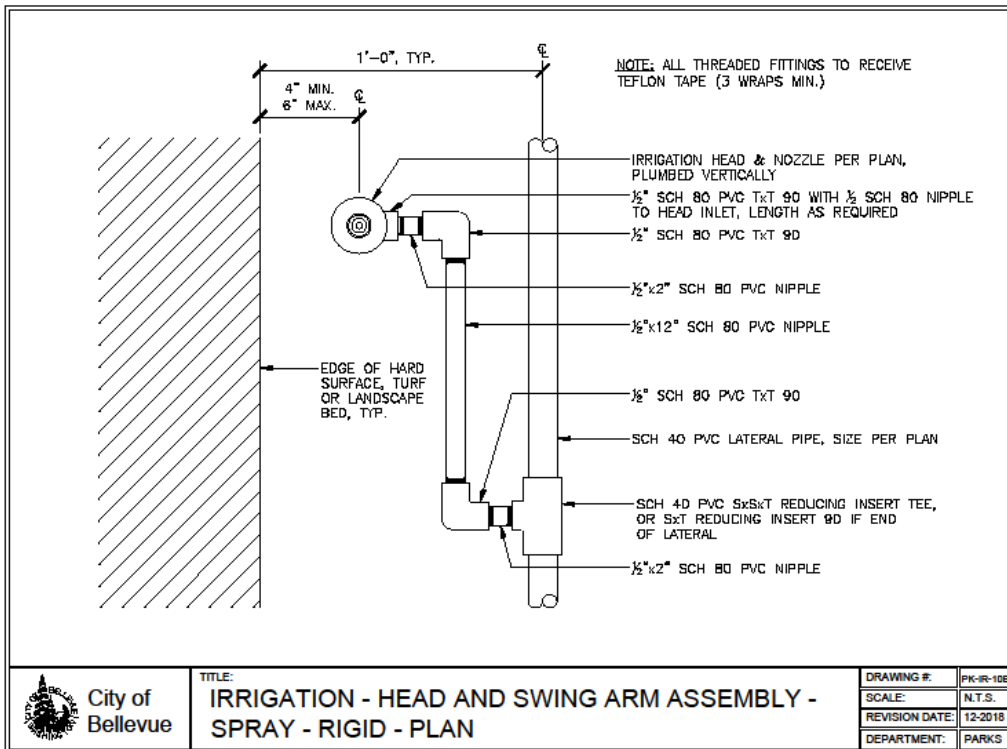
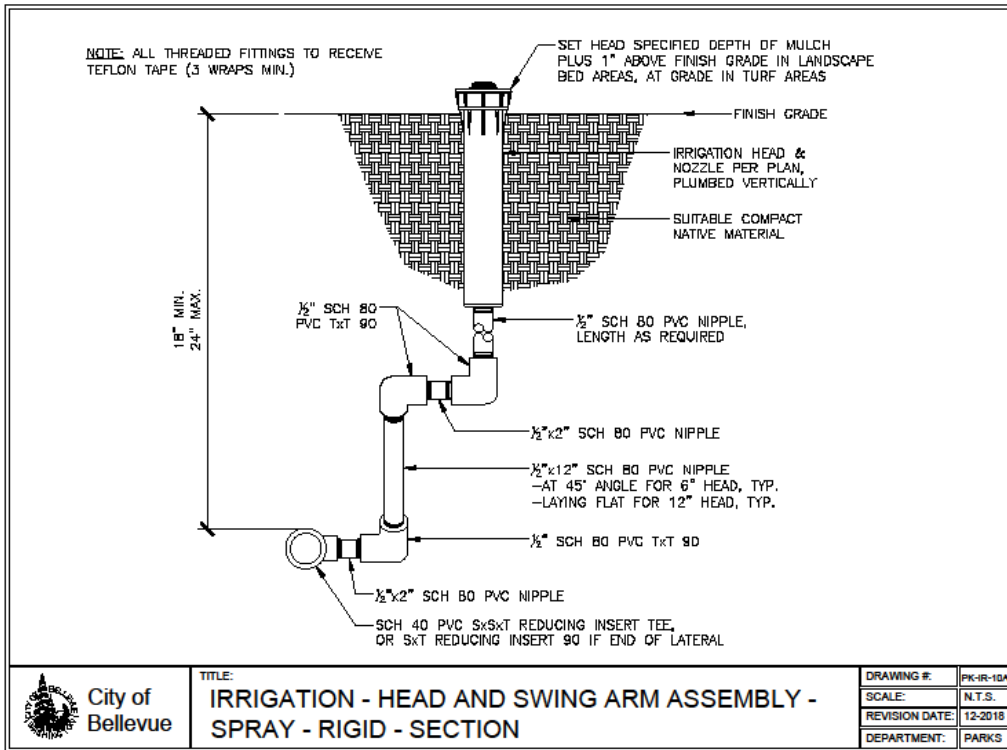

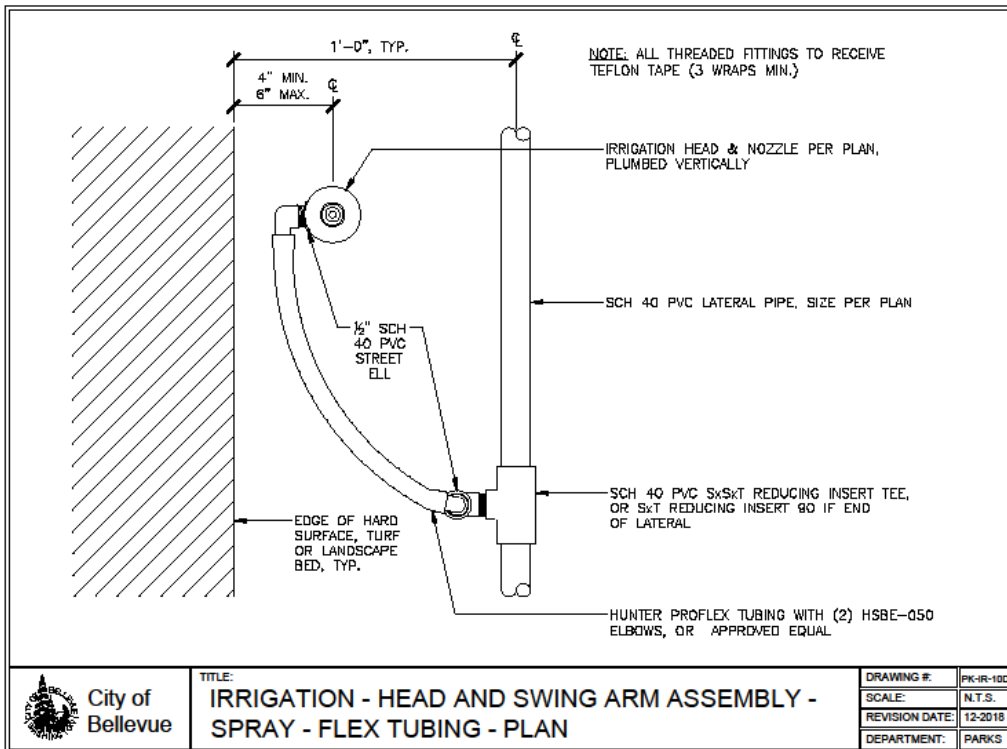
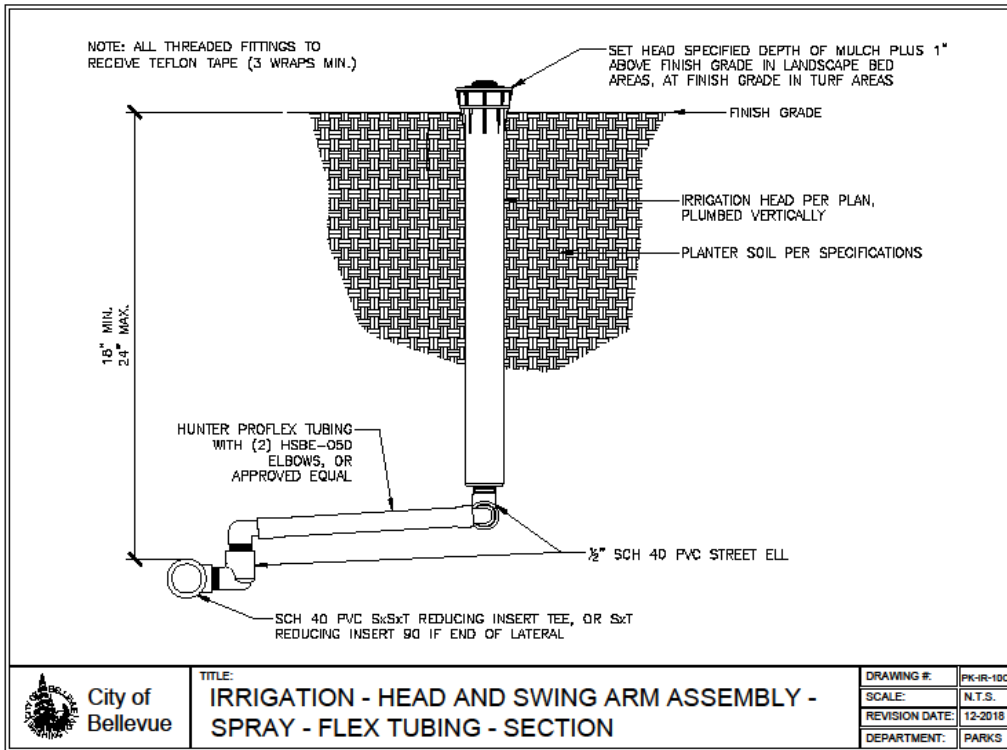

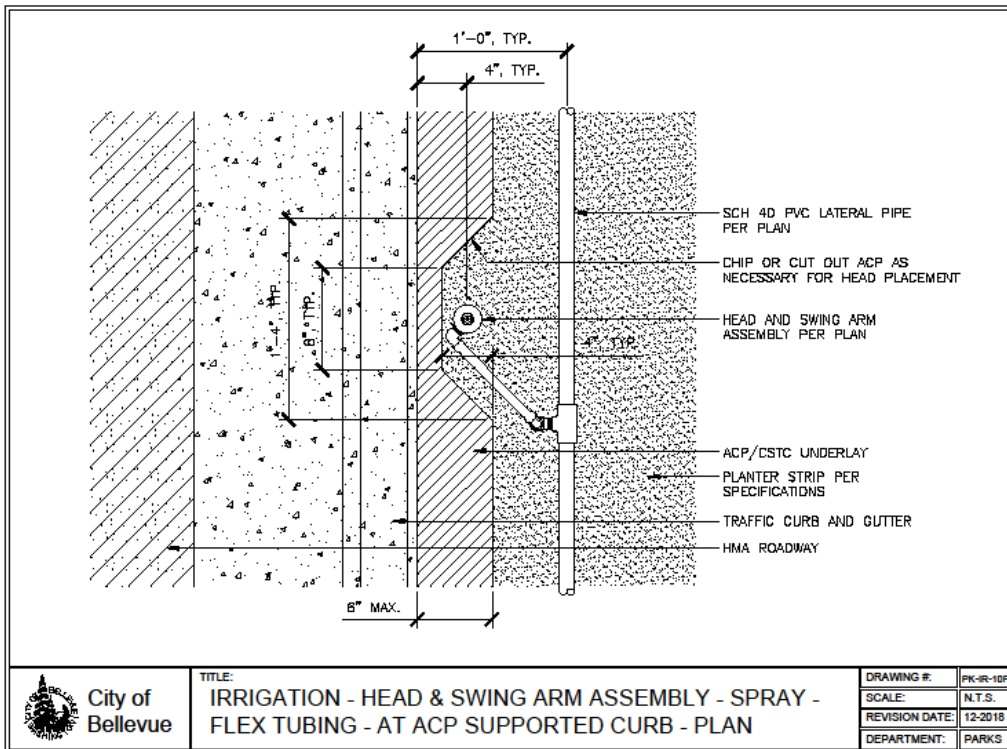
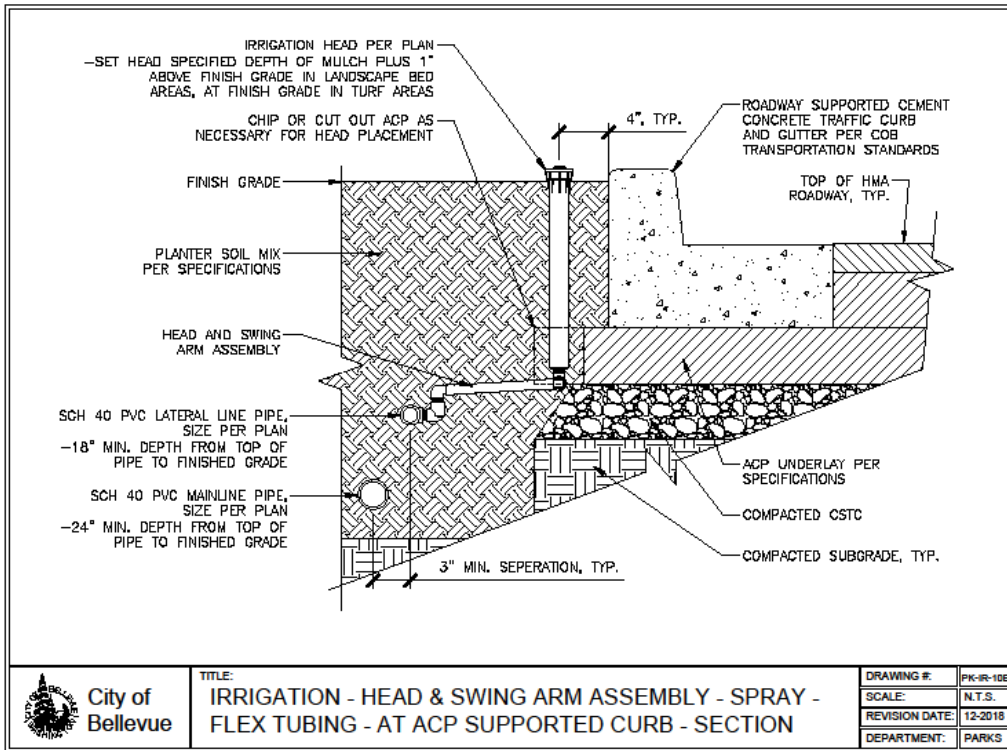



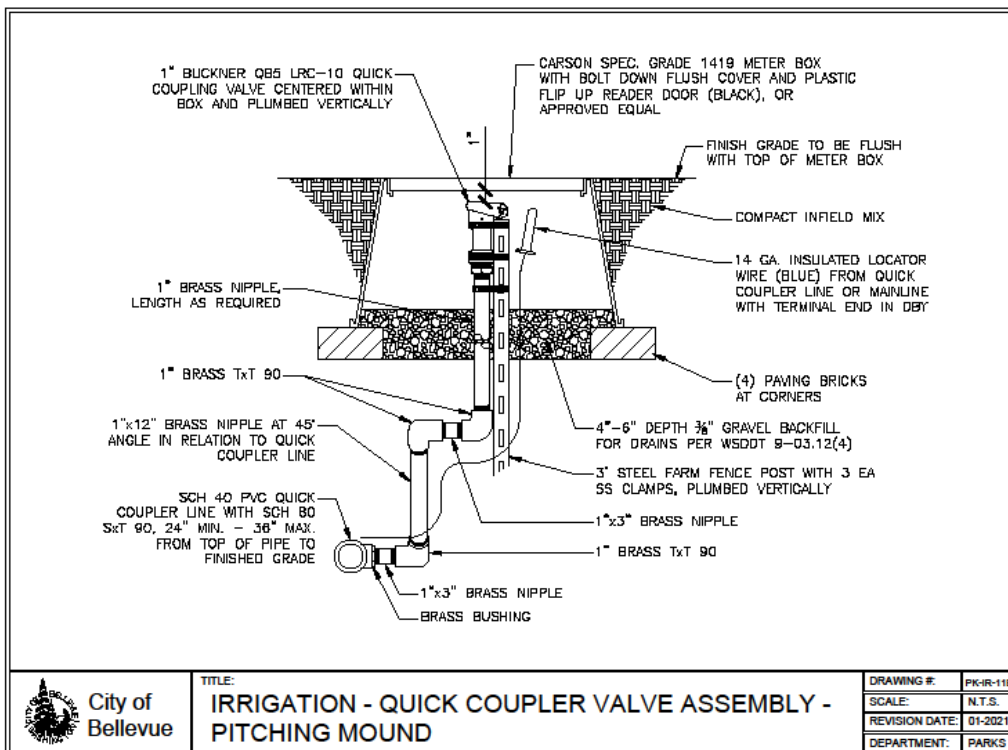
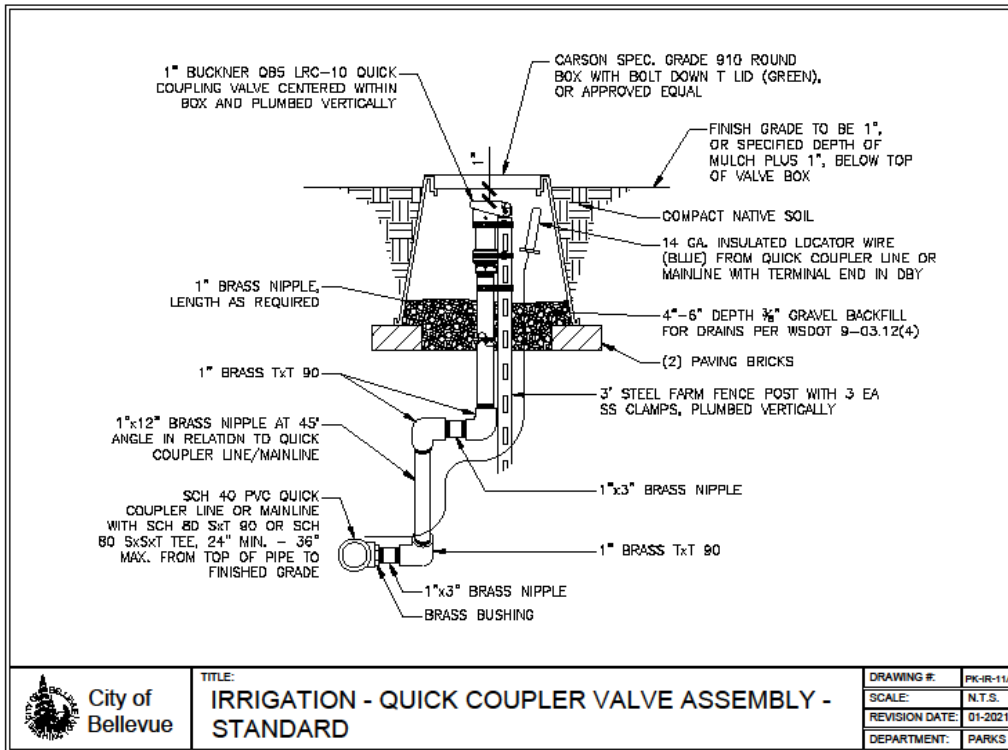

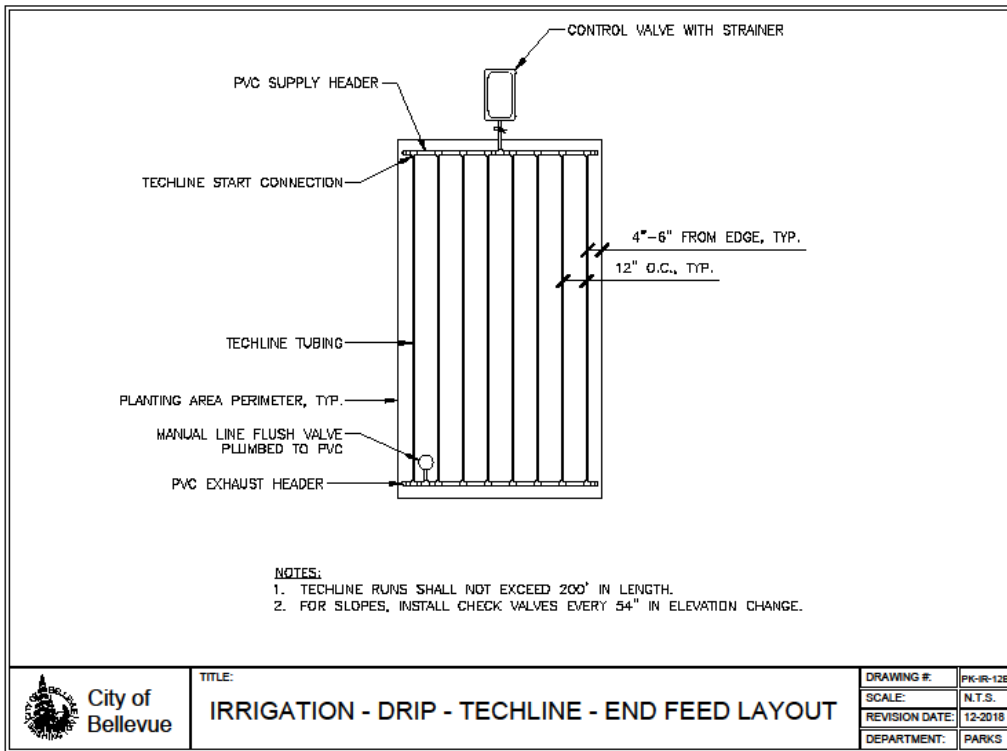
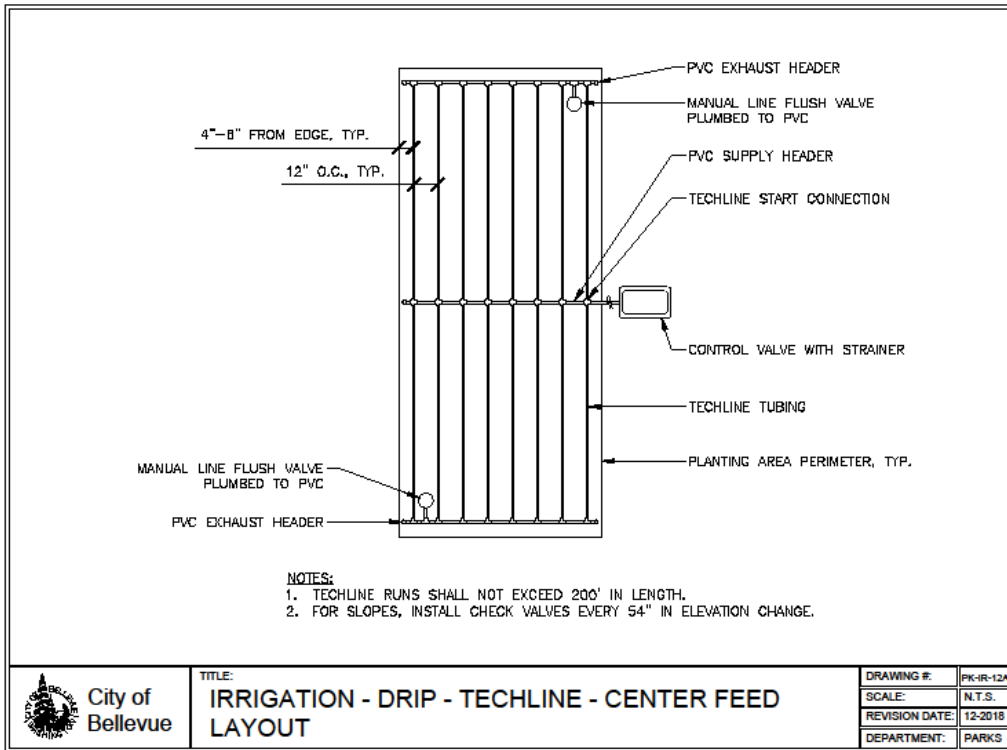

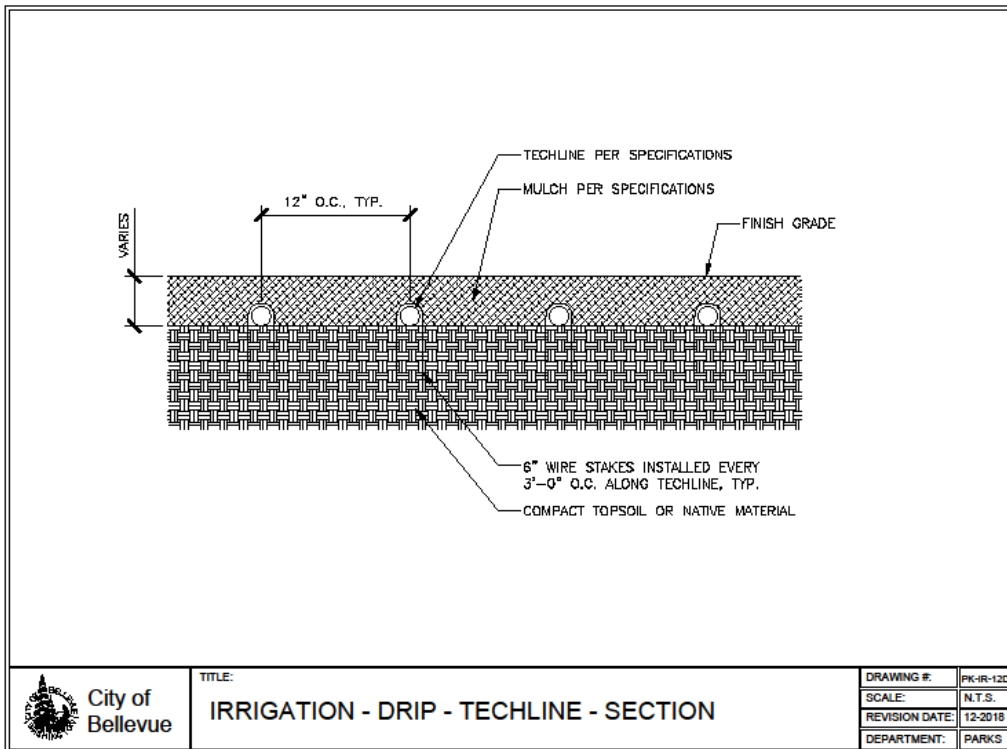
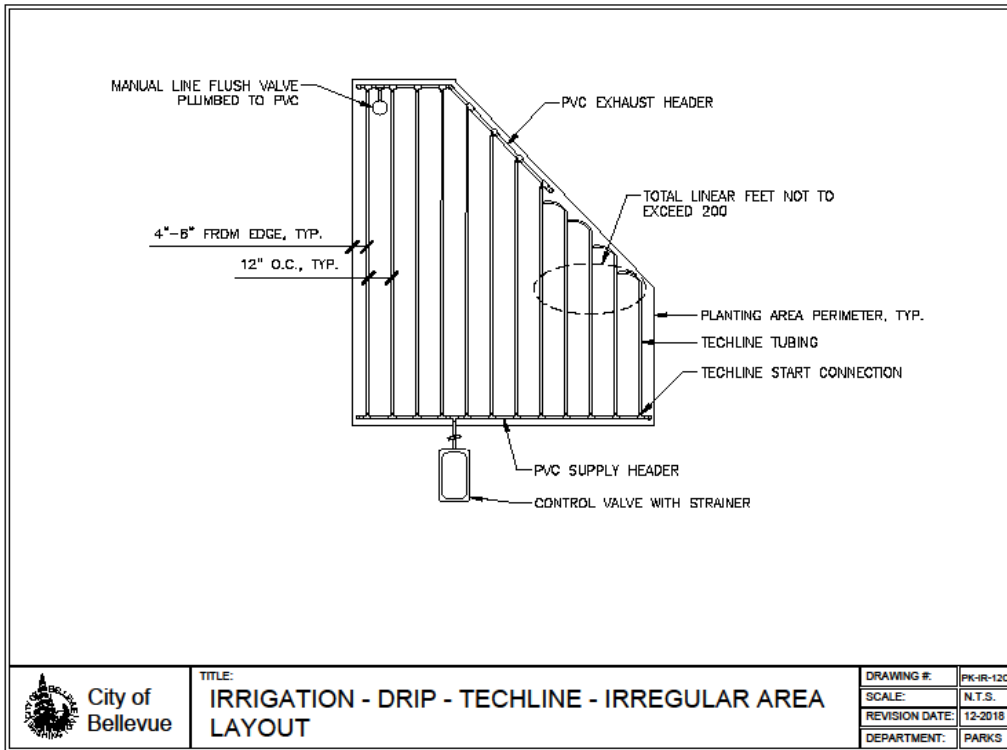

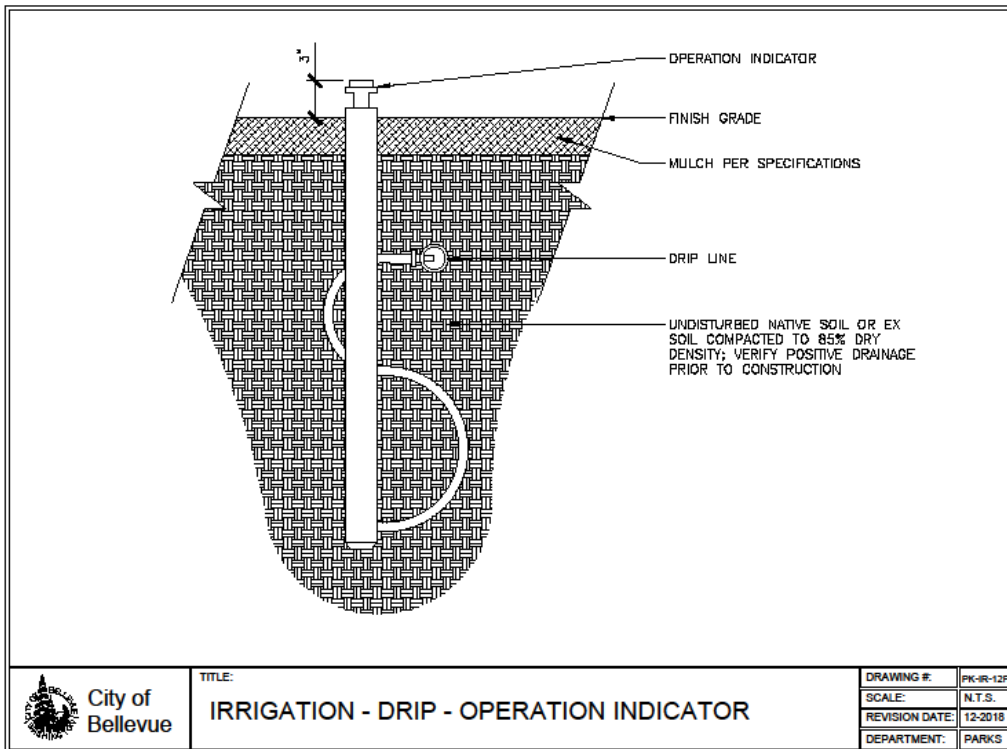
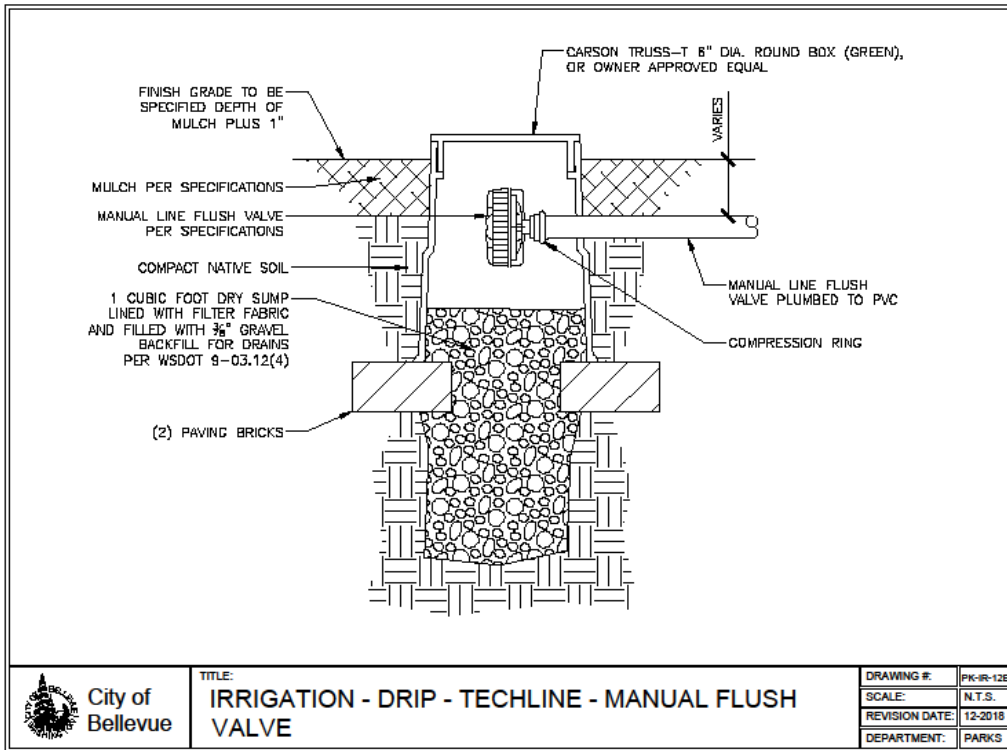

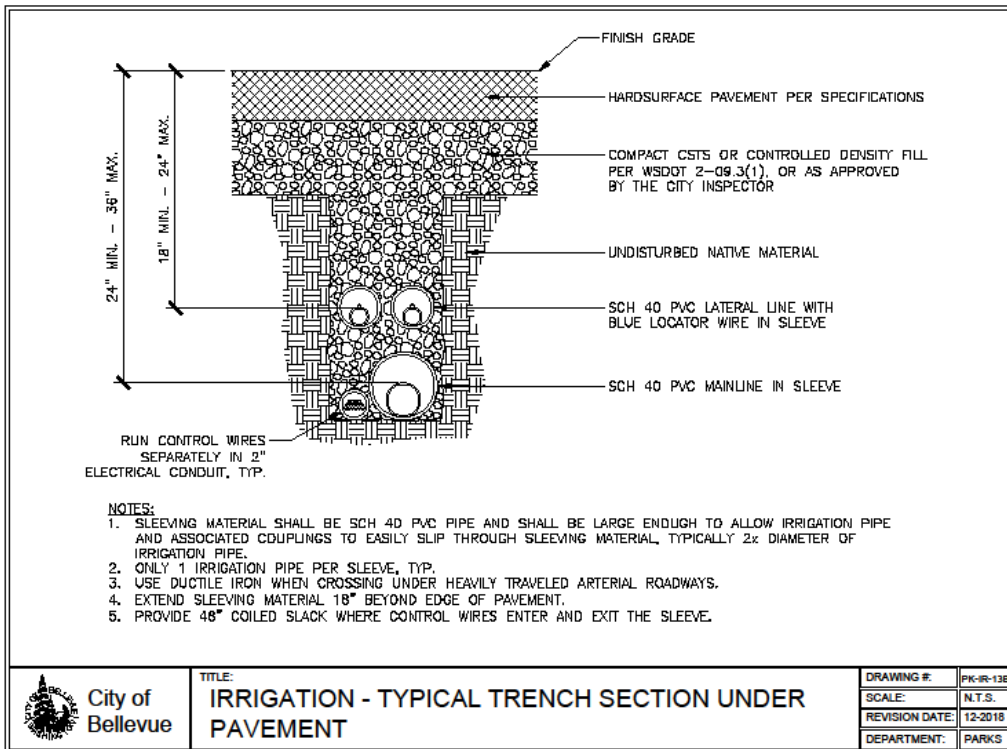
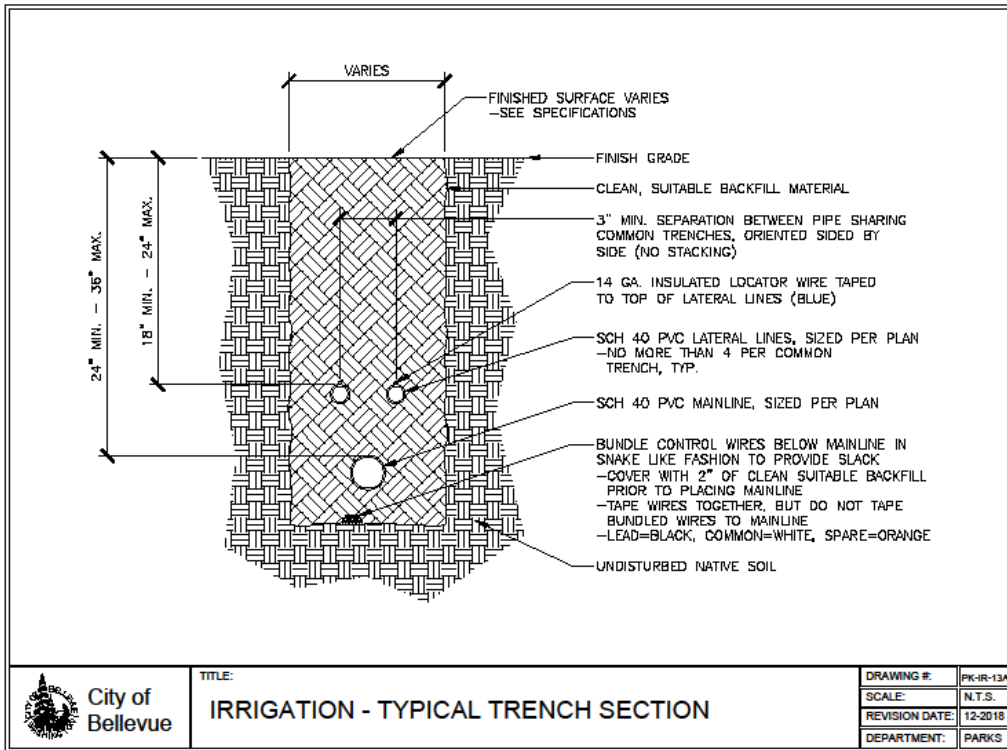

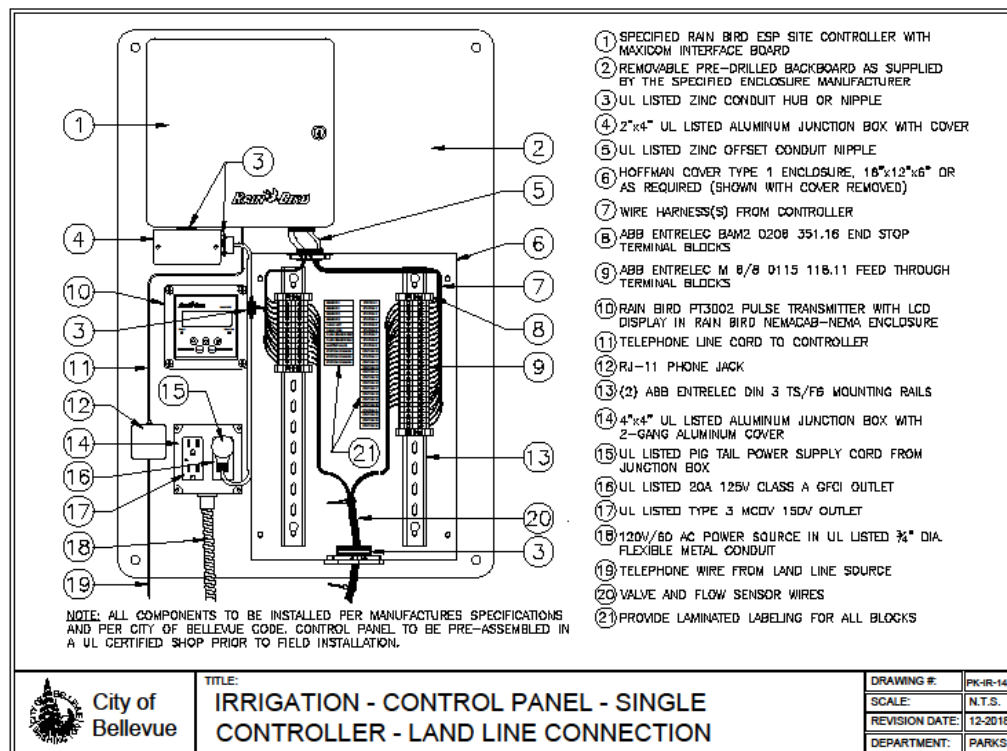
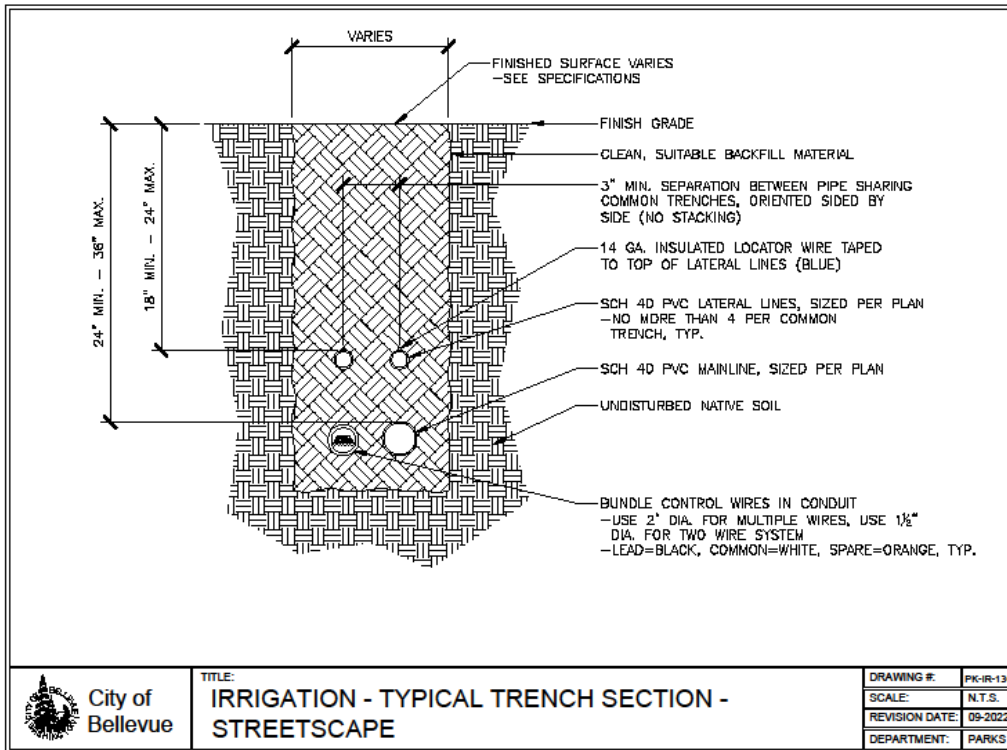

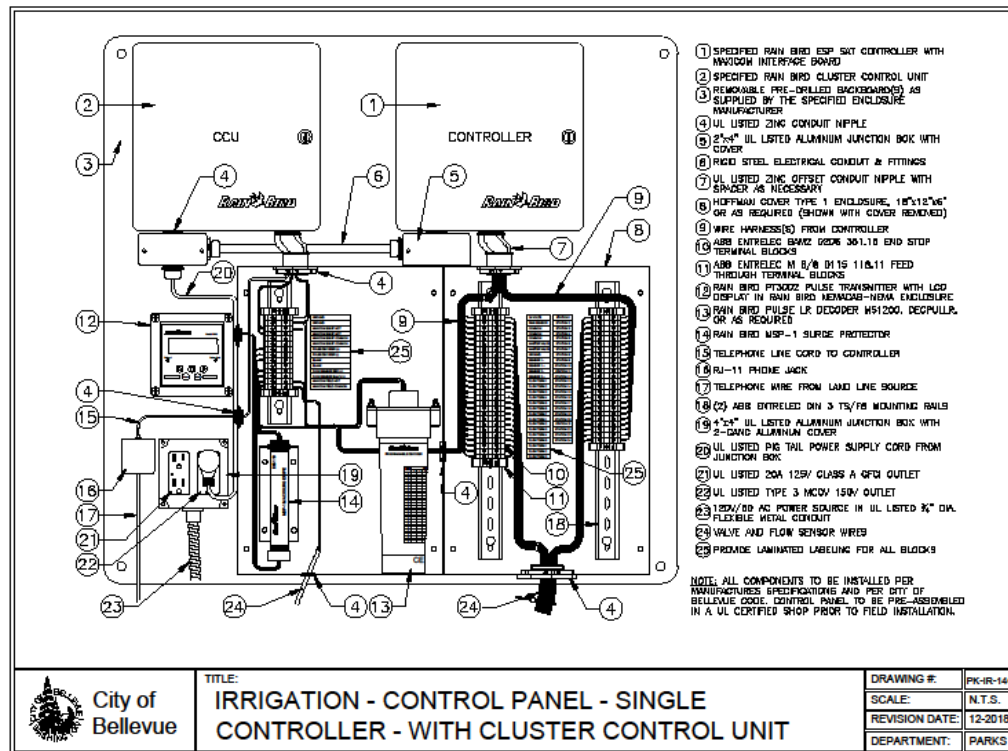
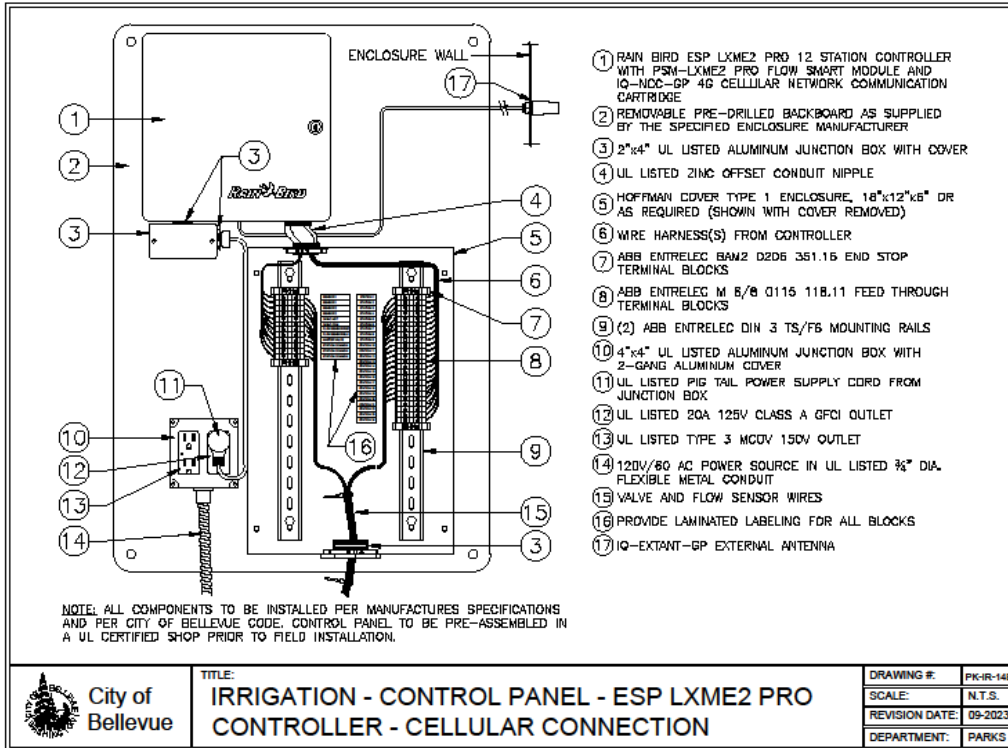

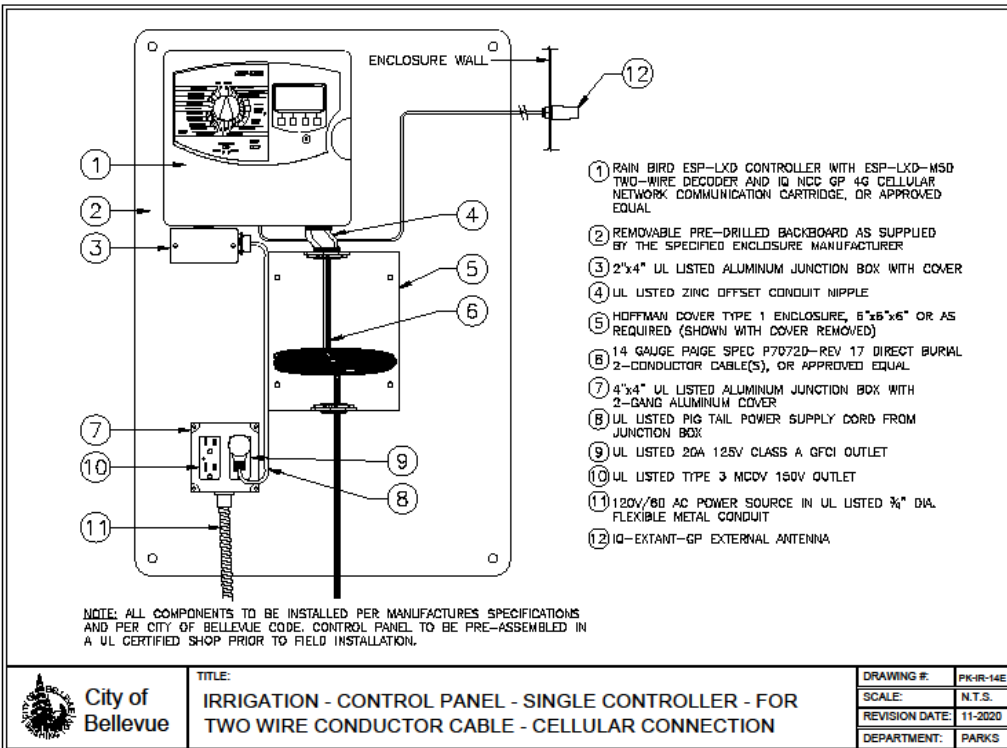
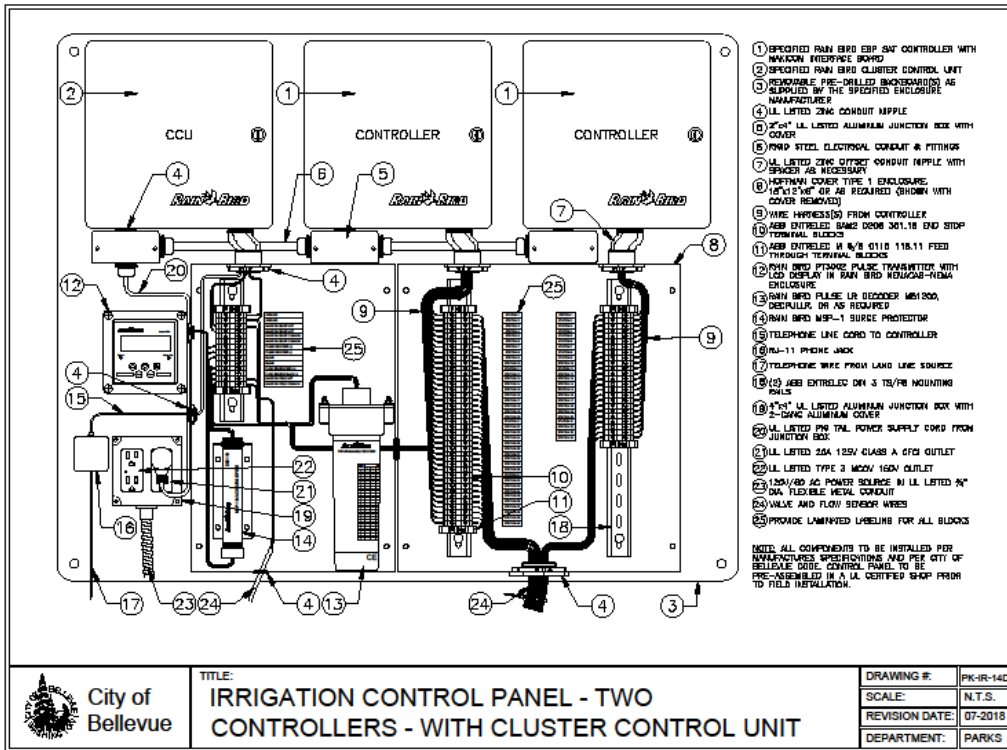



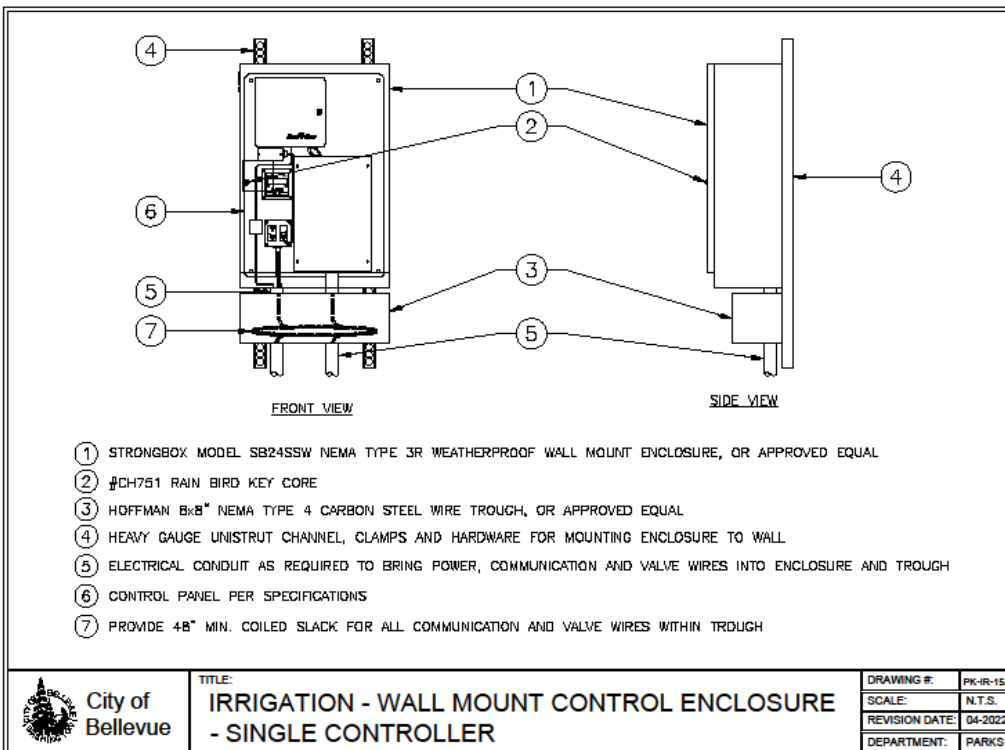
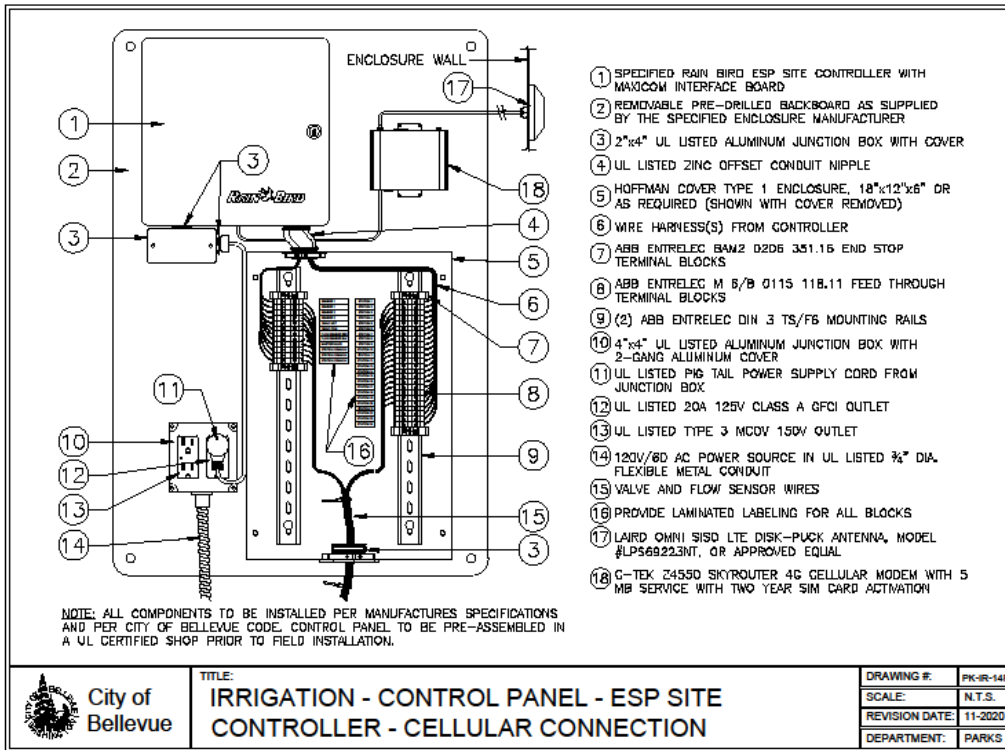

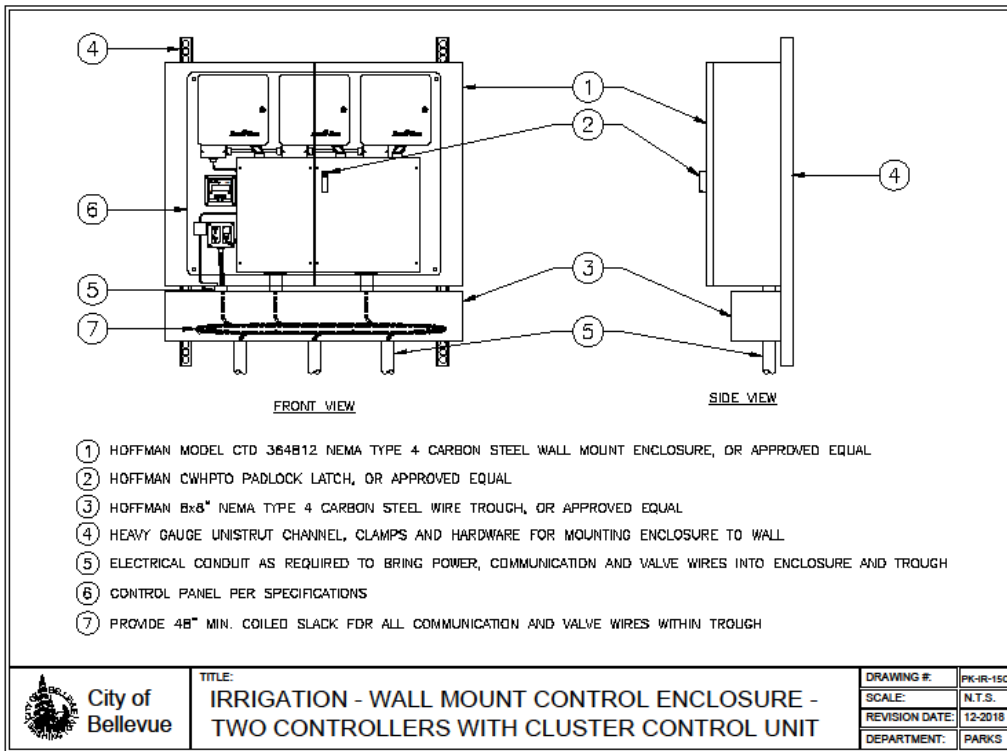
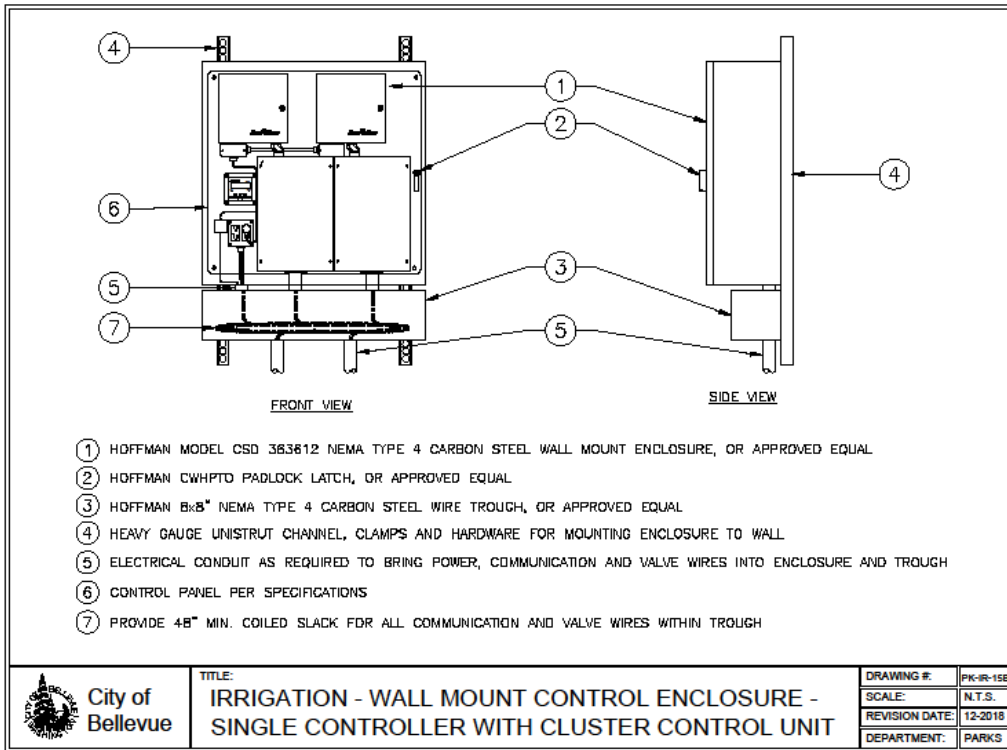

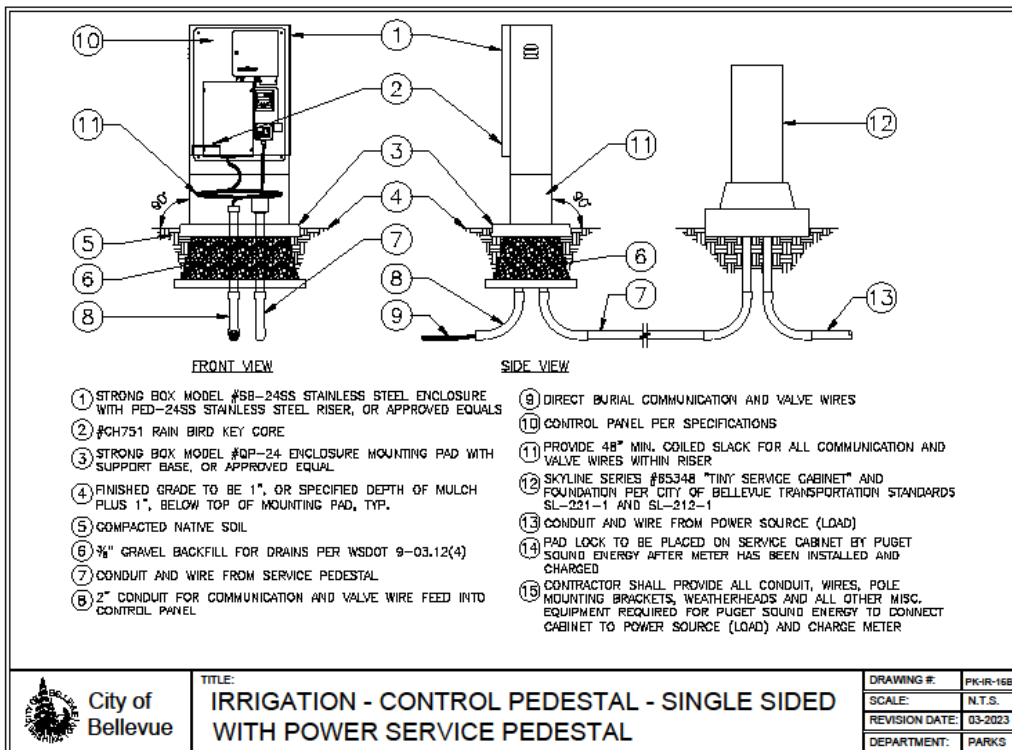
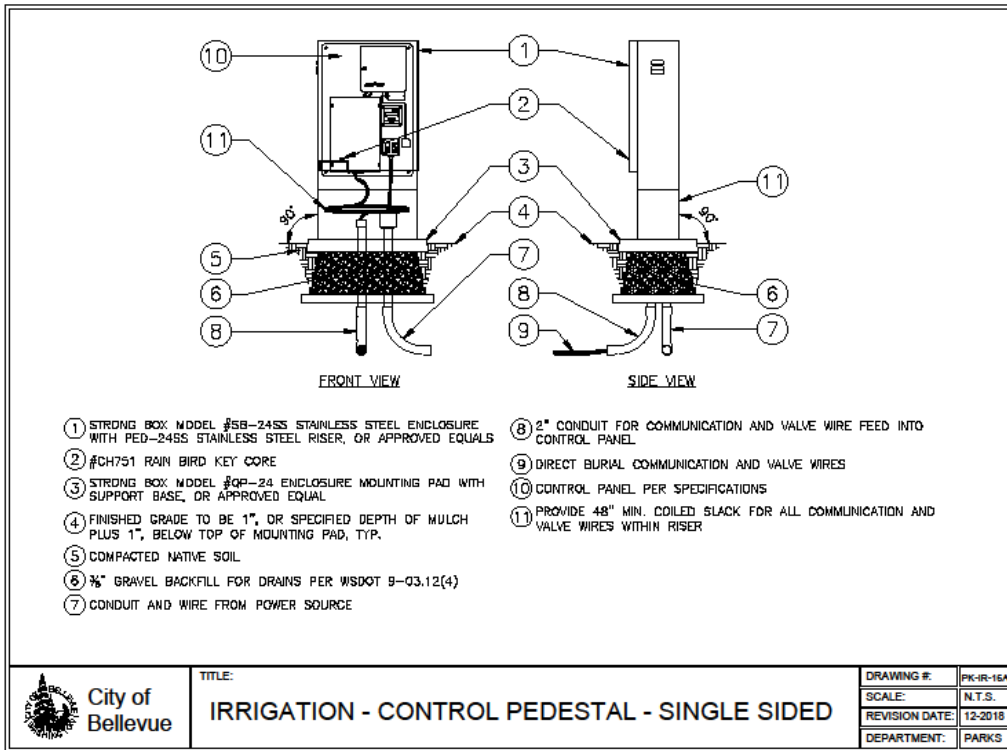

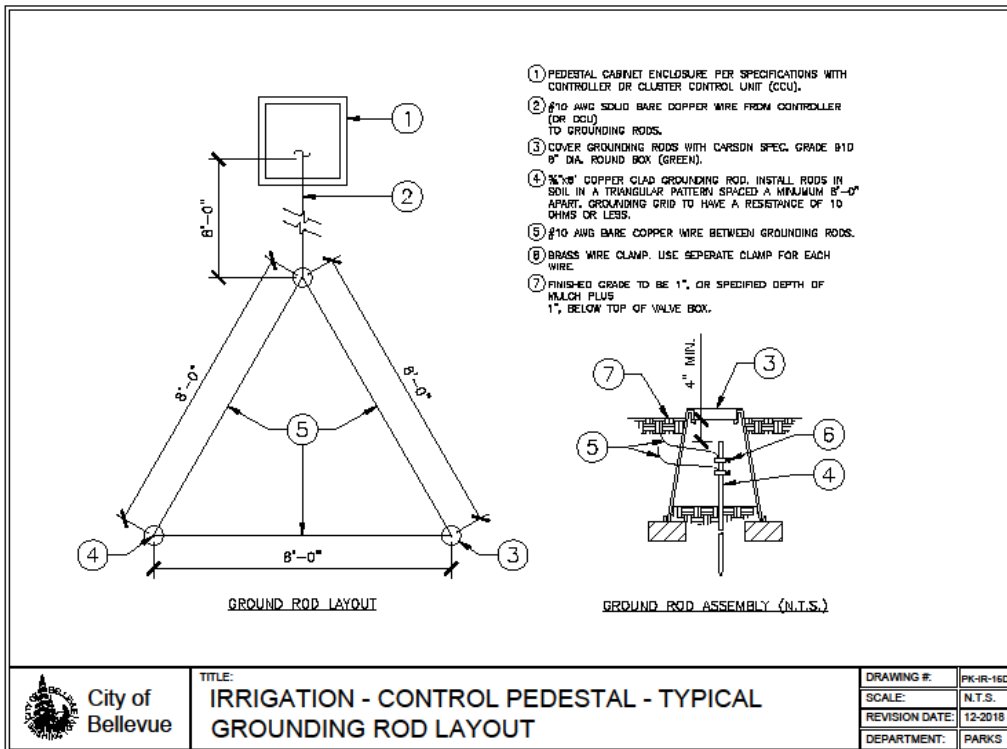
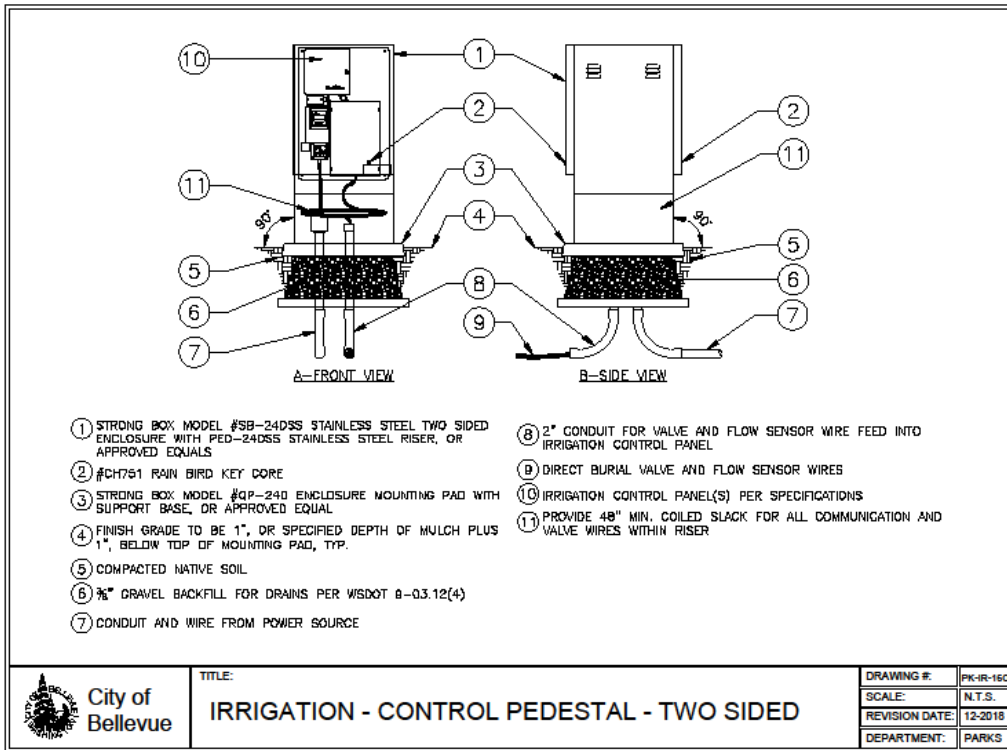



\*If viewing in PDF, click on text to open reference material

**CITY OF BELLEVUE UTILITIES REFERENCE DRAWINGS FOR IRRIGATION CONSTRUCTION ON PARKS PROPERTY:**

- W-08: TYPICAL TRENCH DETAIL
- W-23: 1"x1" SINGLE WATER SERVICE OR DOMESTIC IRRIGATION SERVICE (HORIZONTAL METER SETTER)
- W-28: 1-1/2" IRRIGATION WATER SERVICE (COMMERCIAL AND MULTI-FAMILY)
- W-31: 2" IRRIGATION WATER SERVICE

 <b>City of Bellevue</b>	TITLE:	DRAWING #:	PK-IR-17
	<b>IRRIGATION - REFERENCE MATERIAL</b>	SCALE:	N.T.S.
		REVISION DATE:	12-2018
		DEPARTMENT:	PARKS

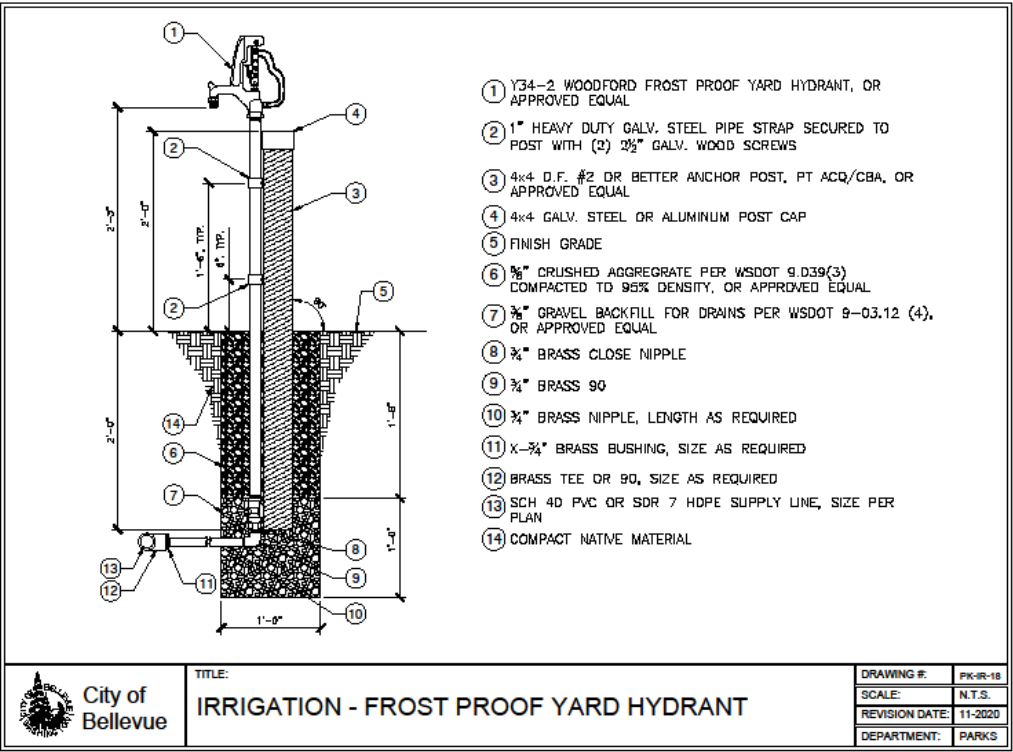

 <b>City of Bellevue</b>	TITLE:	DRAWING #:	PK-IR-18
	<b>IRRIGATION - FROST PROOF YARD HYDRANT</b>	SCALE:	N.T.S.
		REVISION DATE:	11-2020
		DEPARTMENT:	PARKS

## Site Improvements

---



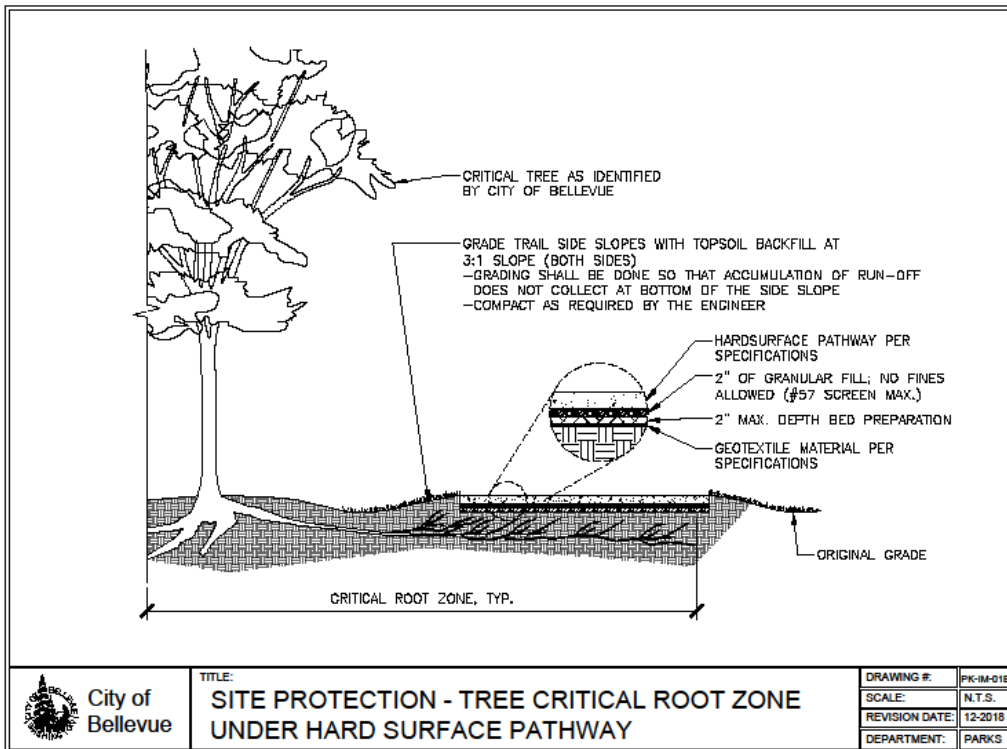
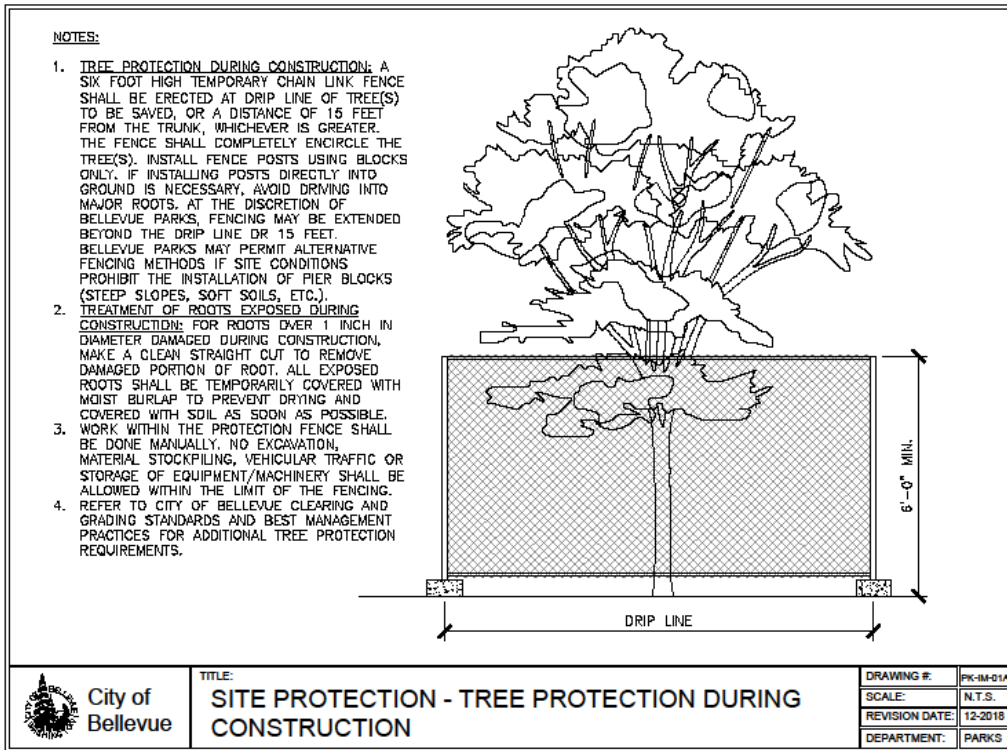

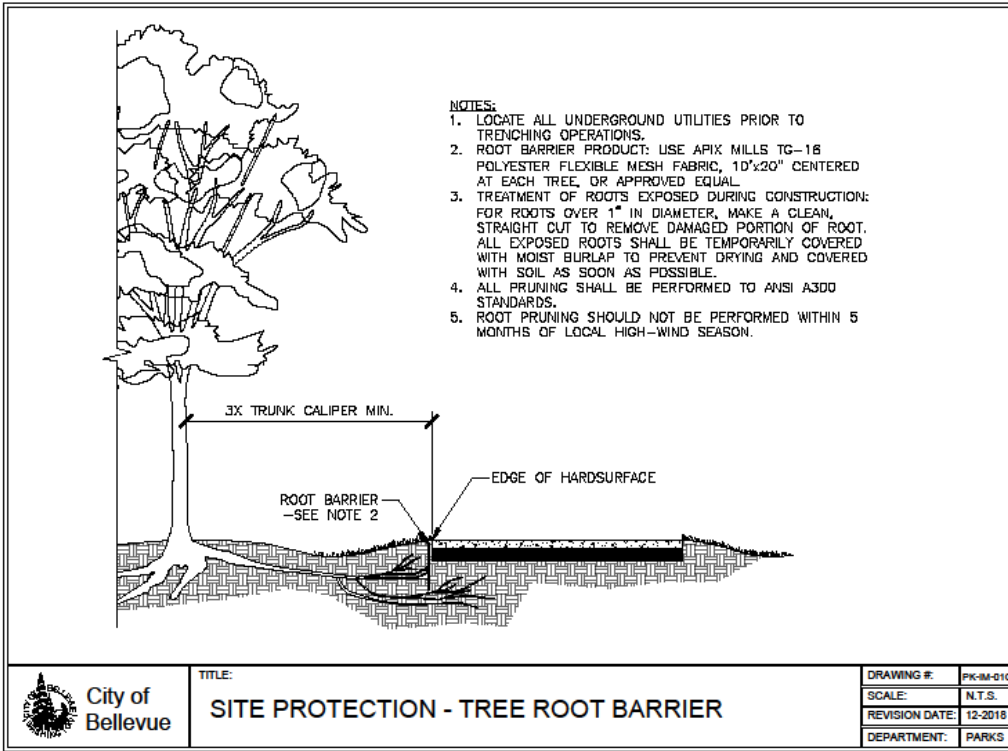

City of Bellevue

TITLE:

SITE PROTECTION - TREE ROOT BARRIER

DRAWING #:	PK-IM-01C
SCALE:	N.T.S.
REVISION DATE:	12-2018
DEPARTMENT:	PARKS

CITY OF BELLEVUE CLEARING & GRADING BMP'S FOR SITE IMPROVEMENTS ON PARKS PROPERTY:

BMP-C101: PRESERVING NATURAL VEGETATION	BMP-C208: TRIANGULAR SILT DIKE (TSD)
BMP-C102: BUFFER ZONES	BMP-C209: OUTLET PROTECTION
BMP-C103: HIGH VISIBILITY FENCE	BMP-C220: STORM DRAIN INLET PROTECTION
BMP-C105: STABILIZED CONSTRUCTION ENTRANCE/EXIT	BMP-C231: BRUSH BARRIER
BMP-C106: WHEEL WASH	BMP-C232: GRAVEL FILTER BERM
BMP-C107: CONSTRUCTION ROAD/PARKING STABILIZATION	BMP-C233: SILT FENCE
BMP-C120: TEMPORARY AND PERMANENT SEEDING	BMP-C234: VEGETATIVE STRIP
BMP-C121: MULCHING	BMP-C235: WATTLES
BMP-C122: NETS AND BLANKETS	BMP-C236: VEGETATIVE FILTRATION
BMP-C123: PLASTIC COVERING	BMP-C240: SEDIMENT TRAP
BMP-C124: SODDING	BMP-C241: TEMPORARY SEDIMENT POND
BMP-C125: TOPSOILING/COMPOSTING	BMP-C250: CONSTRUCTION STORMWATER CHEMICAL TREATMENT
BMP-C126: POLYACRYLAMIDE (PAM) FOR SOIL PROTECTION	BMP-C251: CONSTRUCTION STORMWATER FILTRATION
BMP-C130: SURFACE ROUGHENING	BMP-C252: HIGH PH NEUTRALIZATION USING CO2
BMP-C131: GRADIENT TERRACES	BMP-C253: PH CONTROL FOR HIGH PH WATER
BMP-C140: DUST CONTROL	BMP-T101: TREE PROTECTION REQUIREMENTS
BMP-C150: MATERIALS ON HAND	BMP-T5.13: POST CONSTRUCTION SOIL QUALITY DEPTH
BMP-C151: CONCRETE HANDLING	
BMP-C152: SAWCUTTING AND SURFACE POLLUTION PREVENTION	
BMP-C153: MATERIAL DELIVERY, STORAGE AND CONTAINMENT	
BMP-C154: CONCRETE WASHOUT AREA	
BMP-C180: CERTIFIED EROSION AND SEDIMENT CONTROL LEAD	
BMP-C182: SCHEDULING	
BMP-C200: INTERCEPTOR DIKE AND SWALE	
BMP-C201: GRASS-LINED CHANNELS	
BMP-C202: CHANNEL LINING	
BMP-C203: WATER BARS	
BMP-C204: PIPE SLOPE DRAINS	
BMP-C205: SUBSURFACE DRAINS	
BMP-C206: LEVEL SPREADER	
BMP-C207: CHECK DAMS	



City of Bellevue

TITLE:

SITE PROTECTION - REFERENCE MATERIAL

DRAWING #:	PK-IM-04D
SCALE:	N.T.S.
REVISION DATE:	12-2018
DEPARTMENT:	PARKS



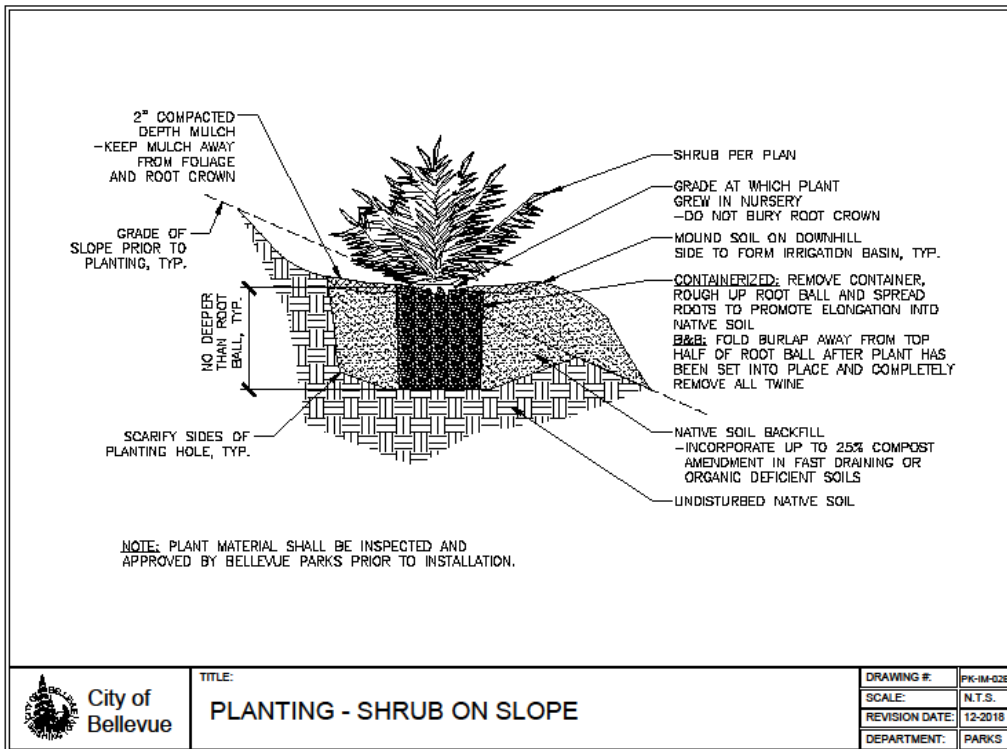
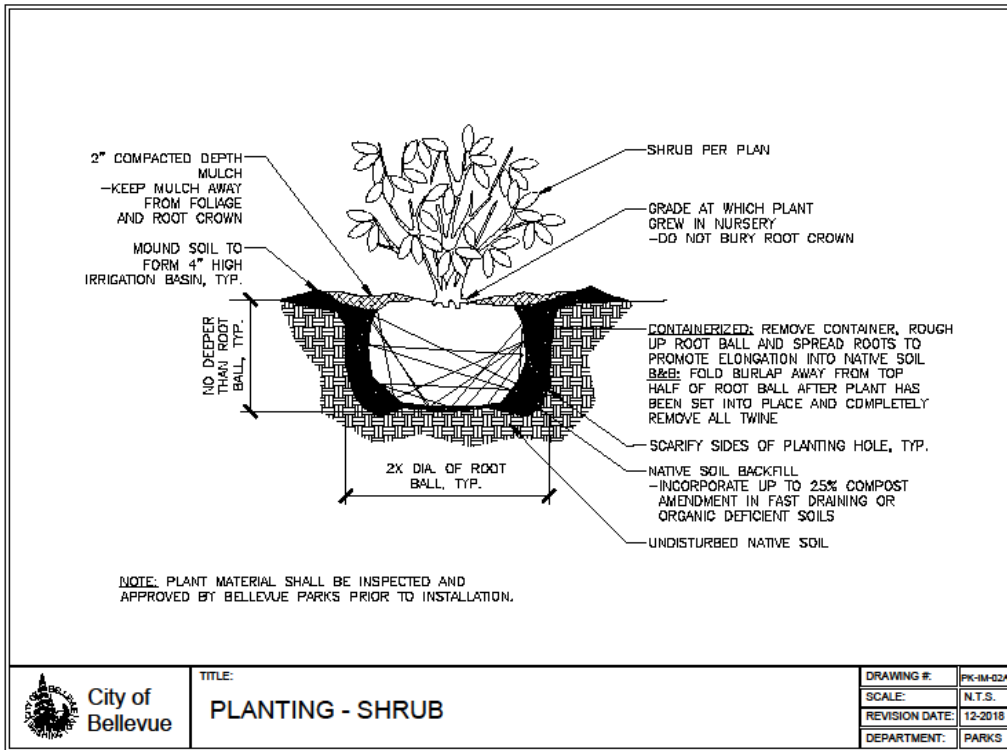

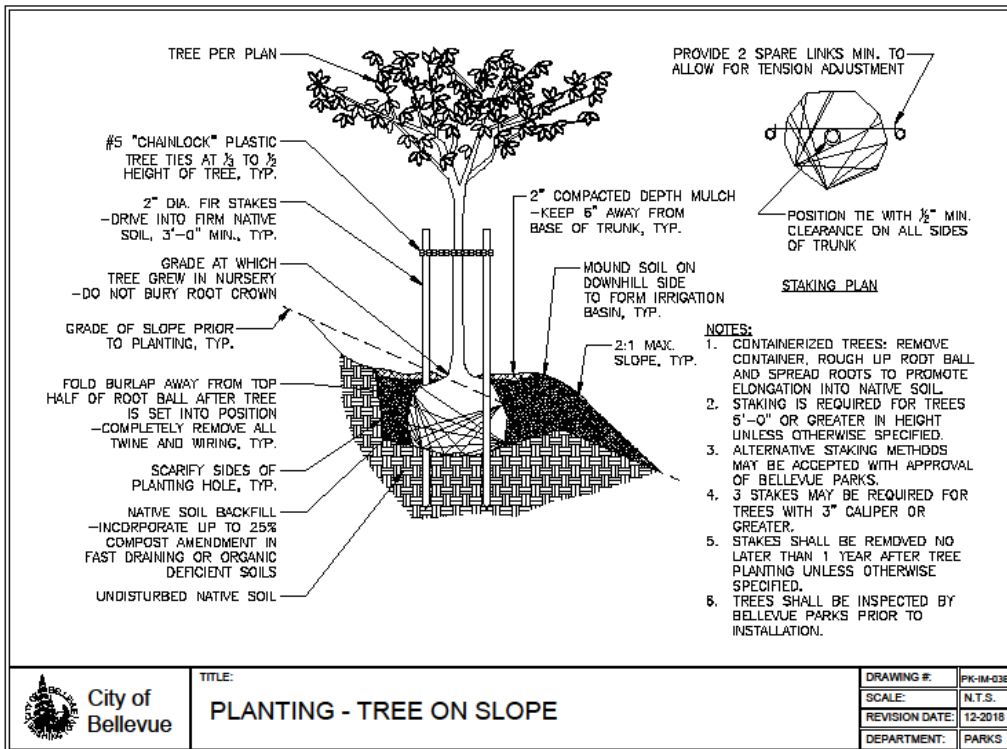
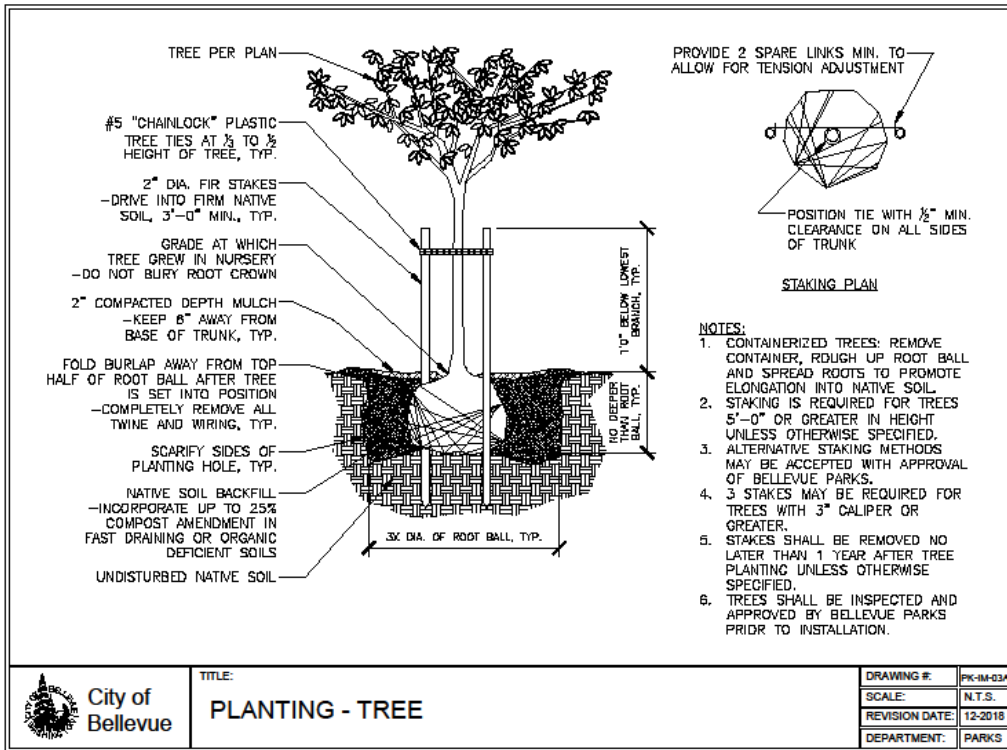

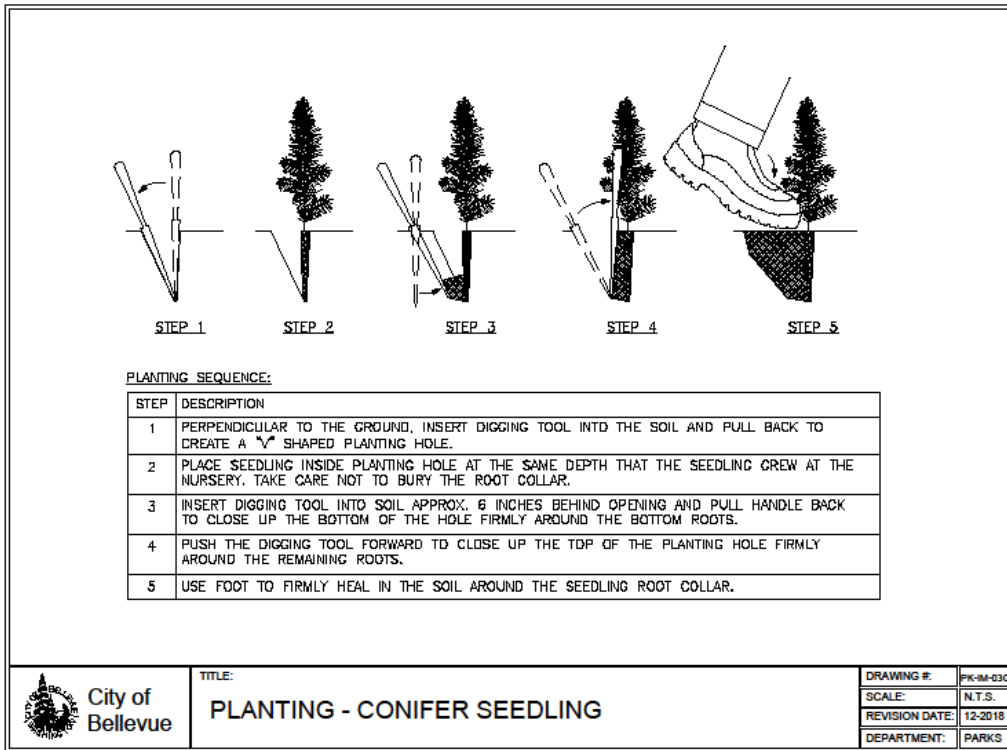

City of Bellevue

TITLE:

PLANTING - CONIFER SEEDLING

DRAWING #:	PK-9M-03C
SCALE:	N.T.S.
REVISION DATE:	12-2018
DEPARTMENT:	PARKS

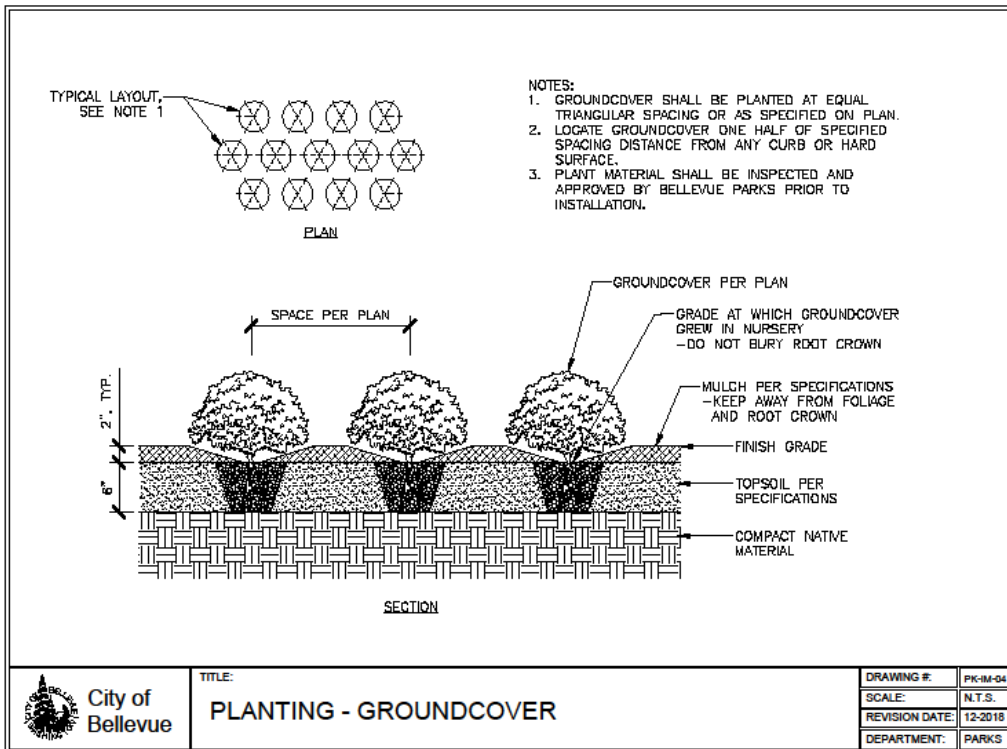

City of Bellevue

TITLE:

PLANTING - GROUNDCOVER

DRAWING #:	PK-9M-04
SCALE:	N.T.S.
REVISION DATE:	12-2018
DEPARTMENT:	PARKS

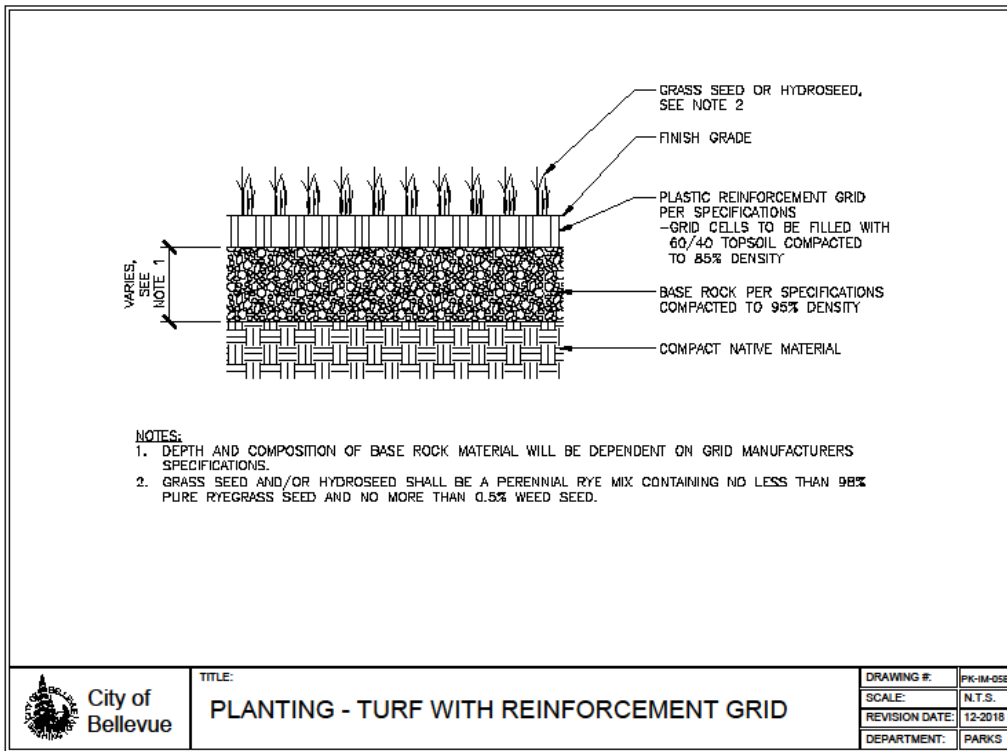
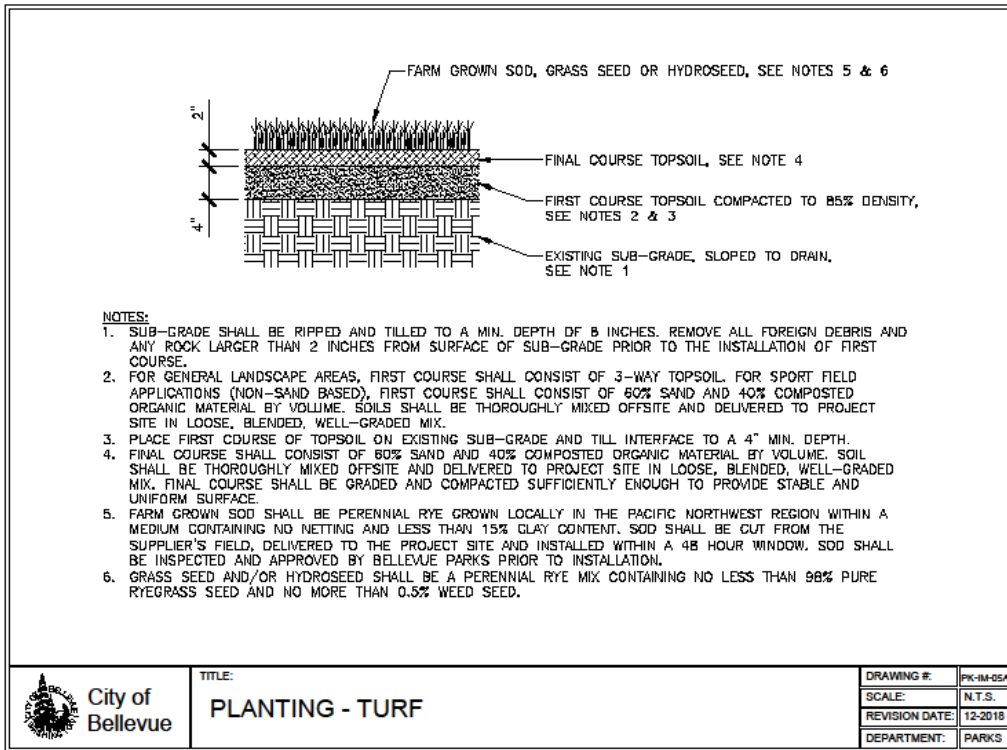

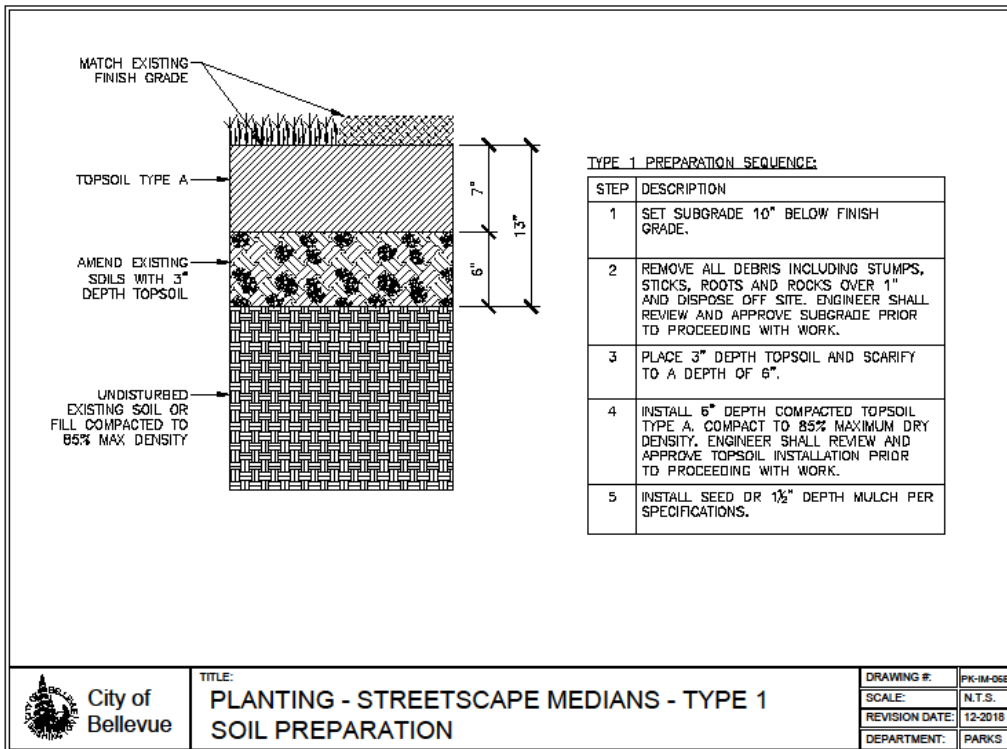
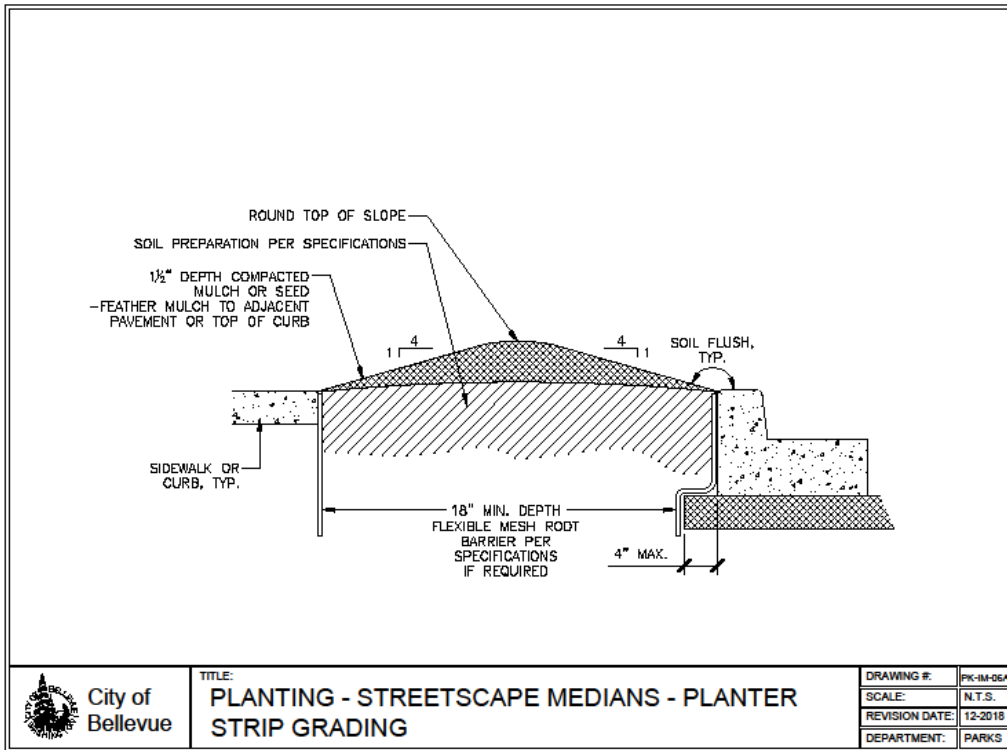

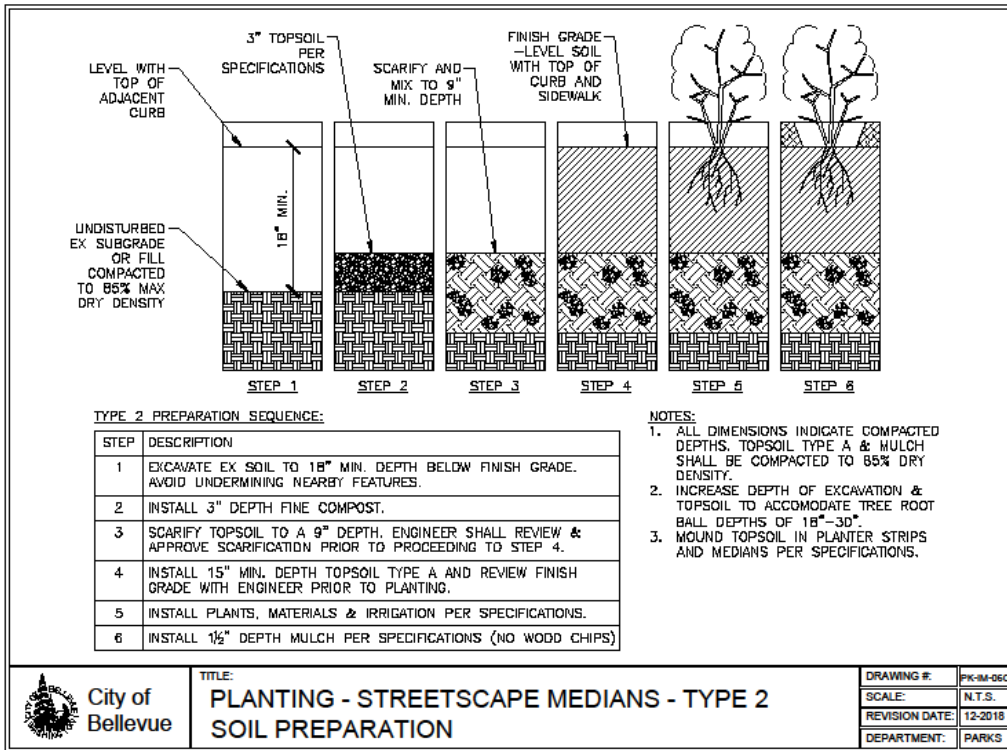

	<b>City of Bellevue</b>	<b>TITLE:</b> <b>PLANTING - STREETSCAPE MEDIANS - TYPE 2</b> <b>SOIL PREPARATION</b>	DRAWING #:	PK-1M-06C
			SCALE:	N.T.S.
			REVISION DATE:	12-2018
			DEPARTMENT:	PARKS

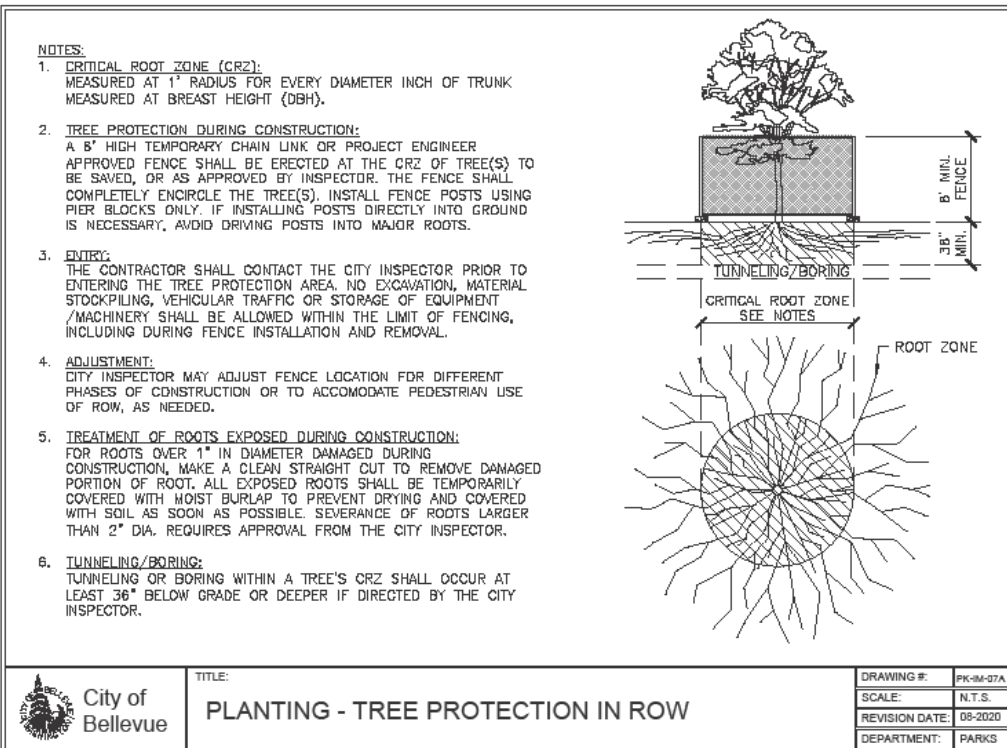

	<b>City of Bellevue</b>	<b>TITLE:</b> <b>PLANTING - TREE PROTECTION IN ROW</b>	DRAWING #:	PK-1M-07A
			SCALE:	N.T.S.
			REVISION DATE:	08-2020
			DEPARTMENT:	PARKS

Standard detail revised with support of King Conservation District

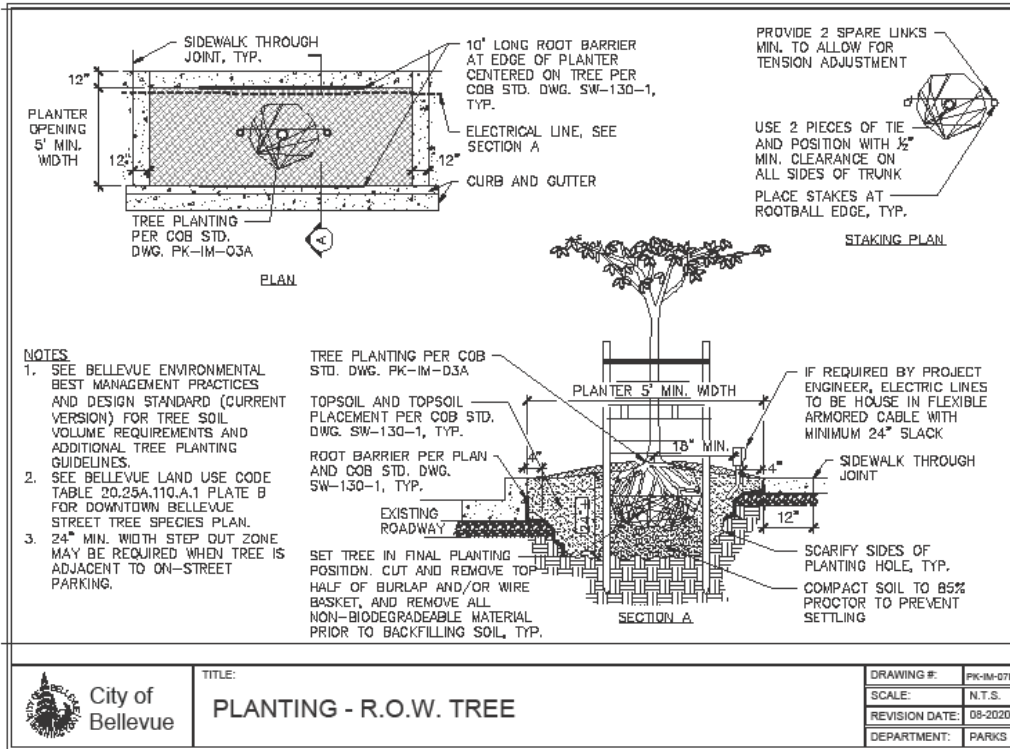

City of Bellevue

TITLE:

PLANTING - R.O.W. TREE

DRAWING #:	PK-IM-07B
SCALE:	N.T.S.
REVISION DATE:	08-2020
DEPARTMENT:	PARKS



Standard detail revised with support of King Conservation District

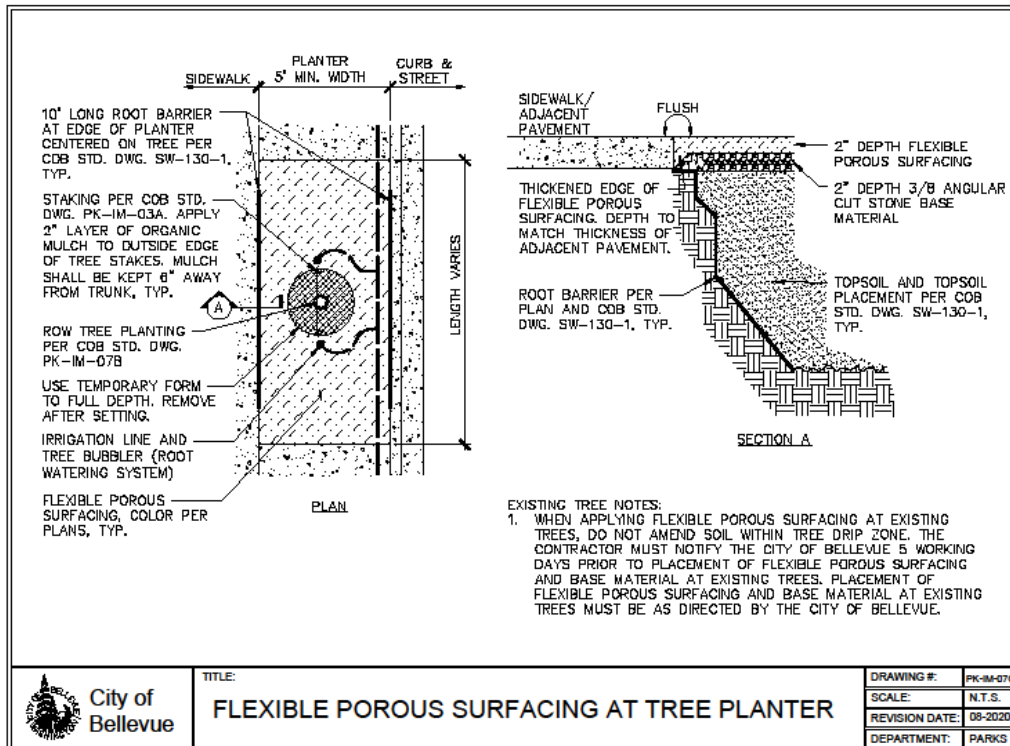

City of Bellevue

TITLE:

FLEXIBLE POROUS SURFACING AT TREE PLANTER

DRAWING #:	PK-IM-07C
SCALE:	N.T.S.
REVISION DATE:	08-2020
DEPARTMENT:	PARKS



Standard detail revised with support of King Conservation District

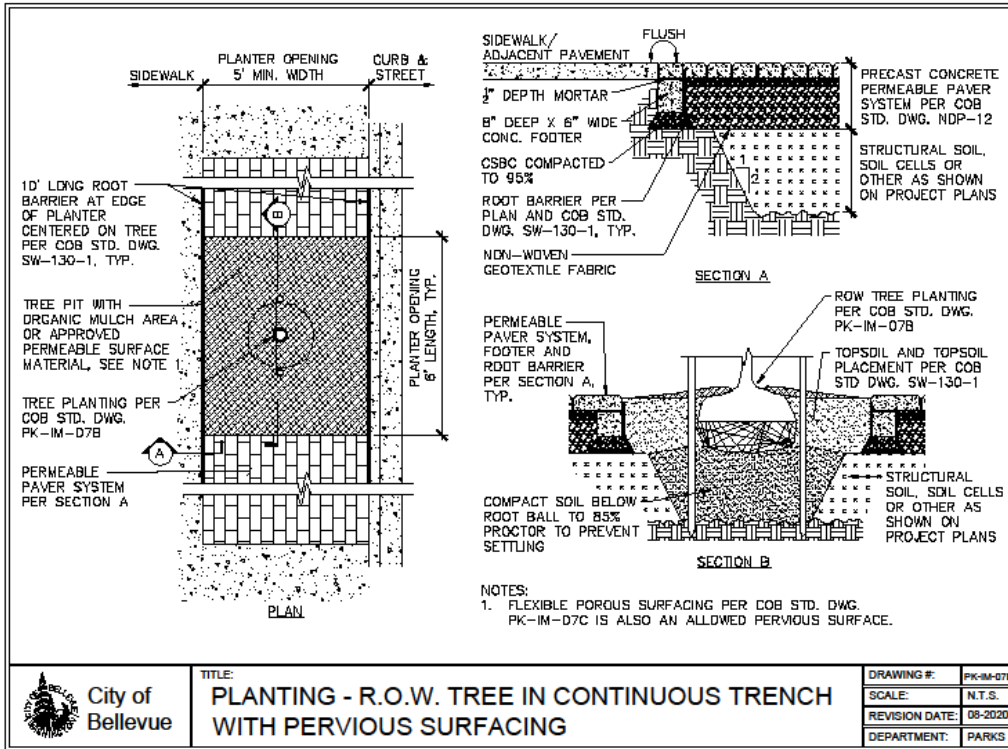

Standard detail revised with support of King Conservation District

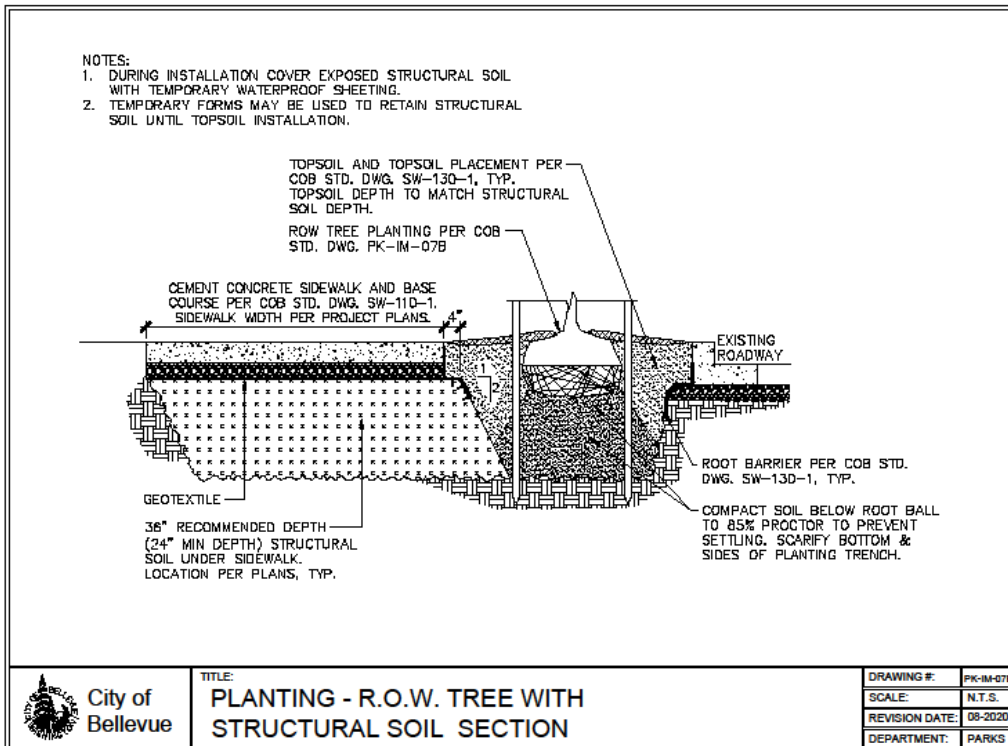

Standard detail revised with support of King Conservation District



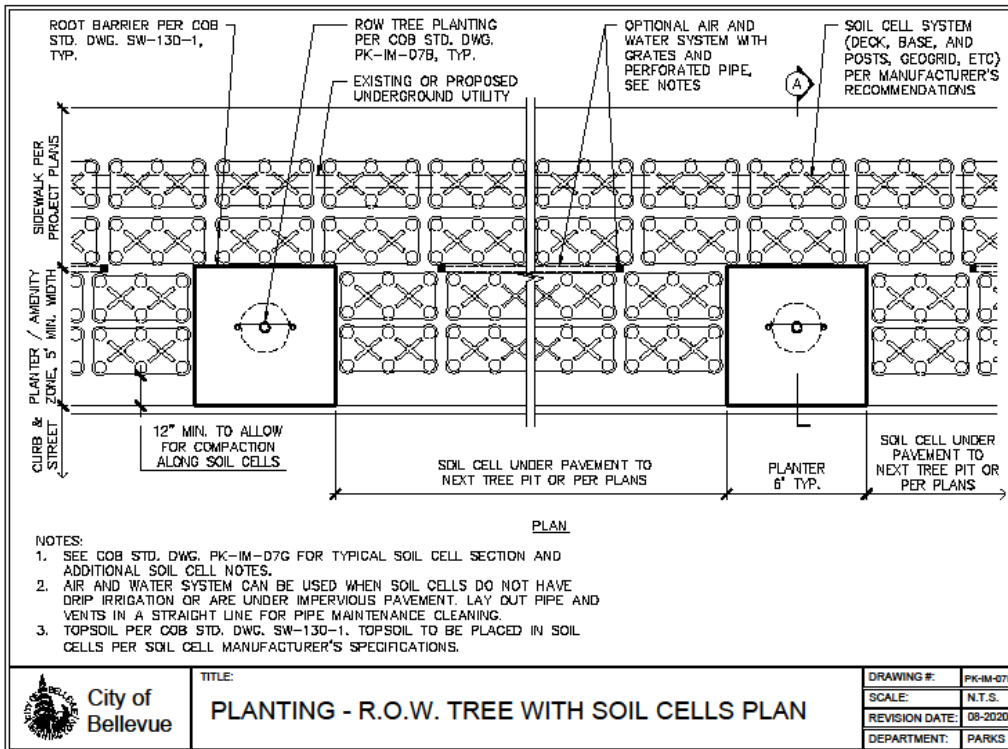

City of Bellevue

TITLE:

PLANTING - R.O.W. TREE WITH SOIL CELLS PLAN



Standard detail revised with support of King Conservation District

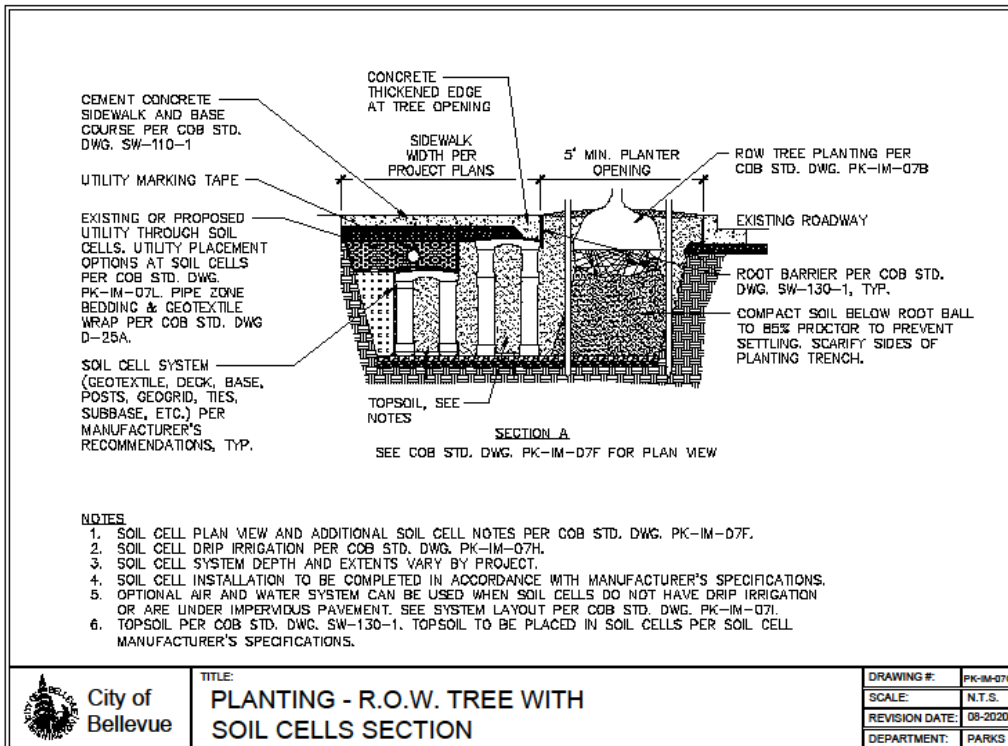

City of Bellevue

TITLE:

PLANTING - R.O.W. TREE WITH SOIL CELLS SECTION



Standard detail revised with support of King Conservation District

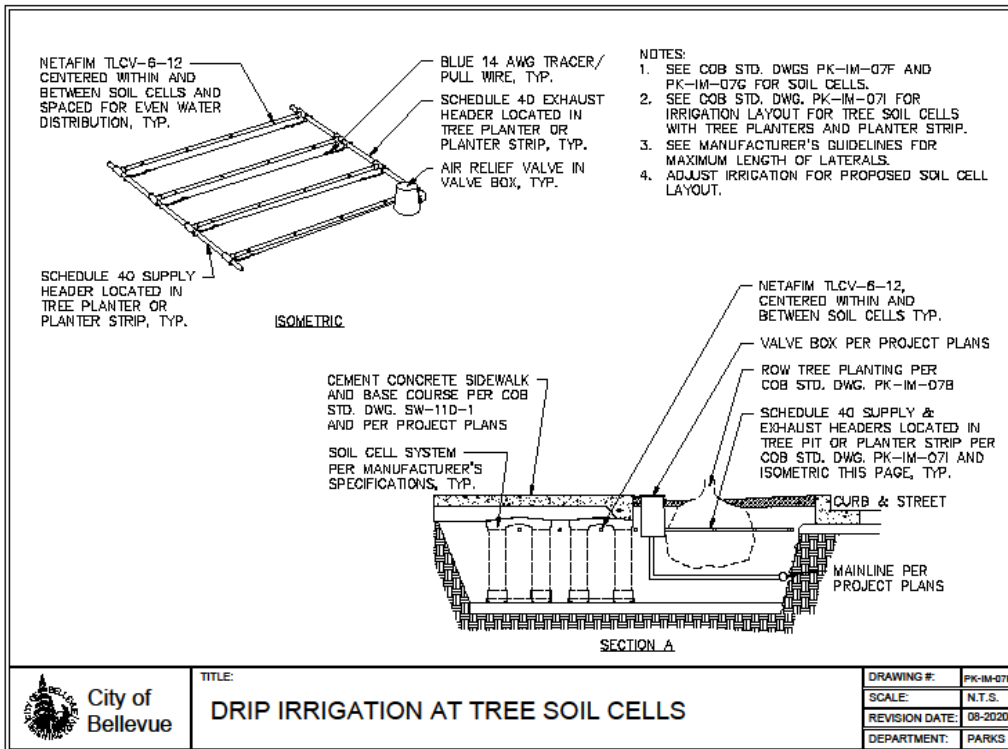

Standard detail revised with support of King Conservation District

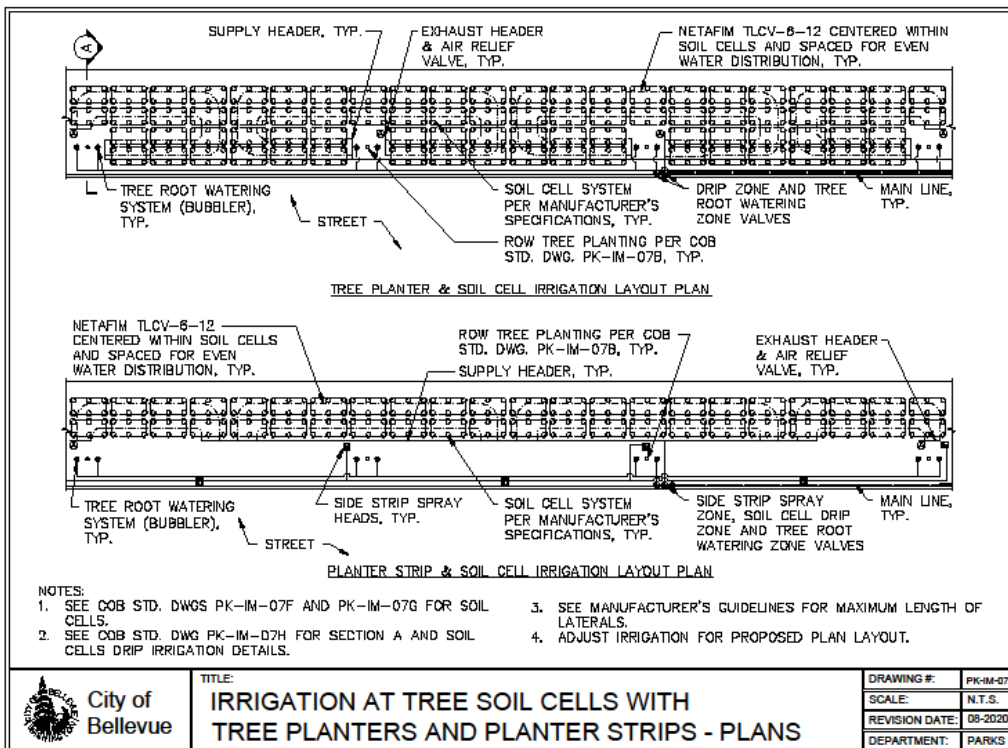

Standard detail revised with support of King Conservation District

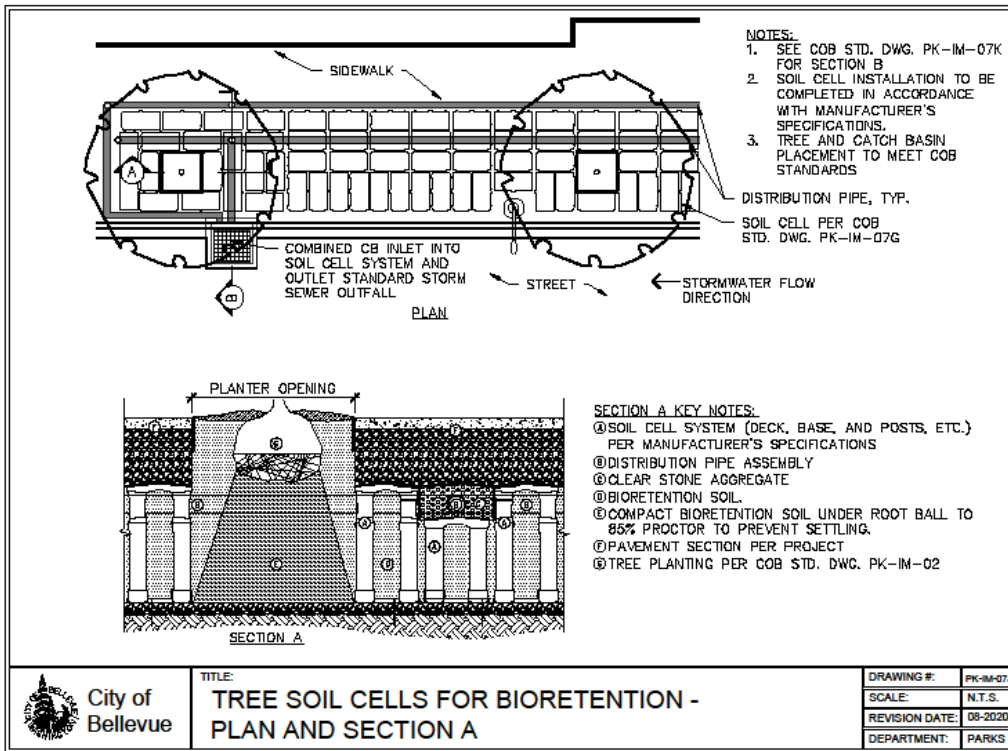

Standard detail revised with support of King Conservation District

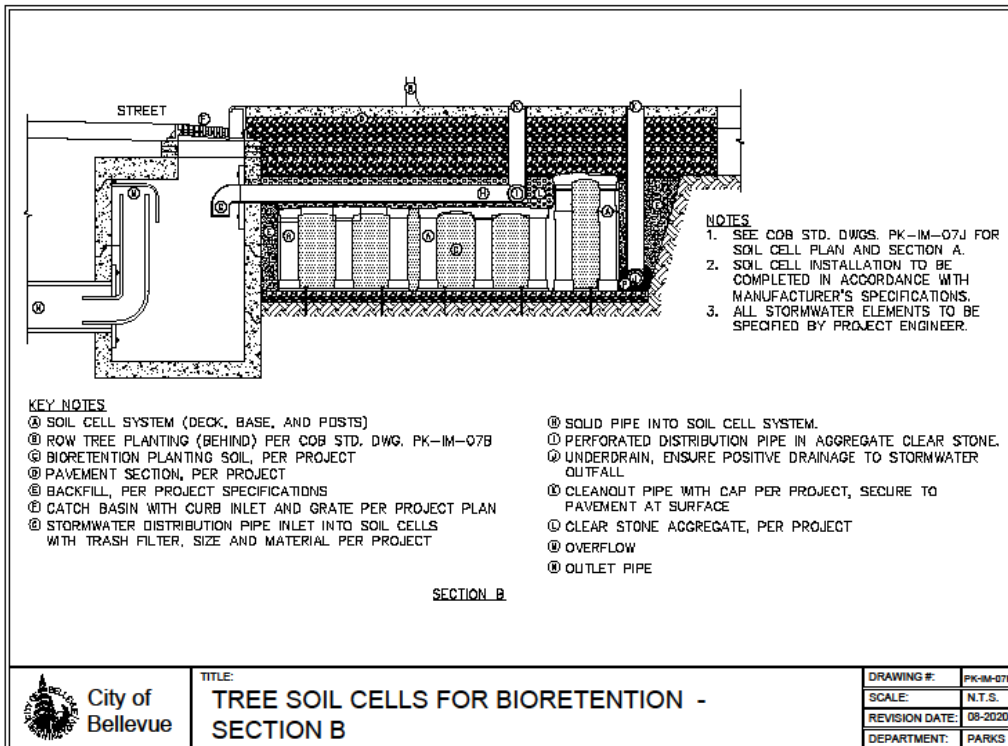

Standard detail revised with support of King Conservation District

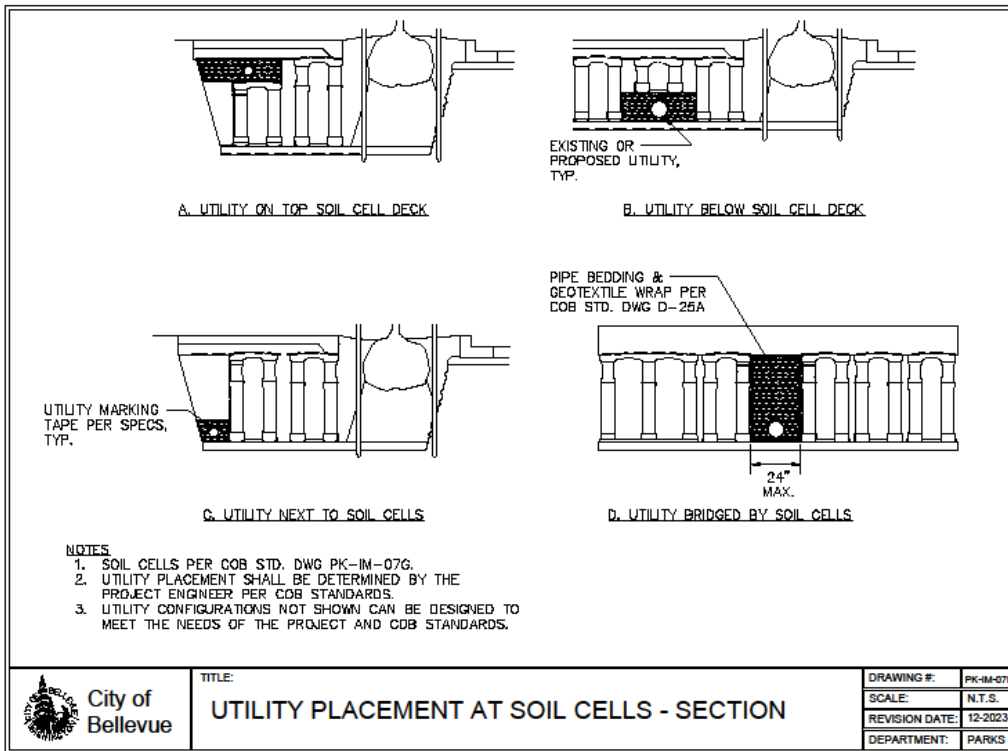

Standard detail revised with support of King Conservation District

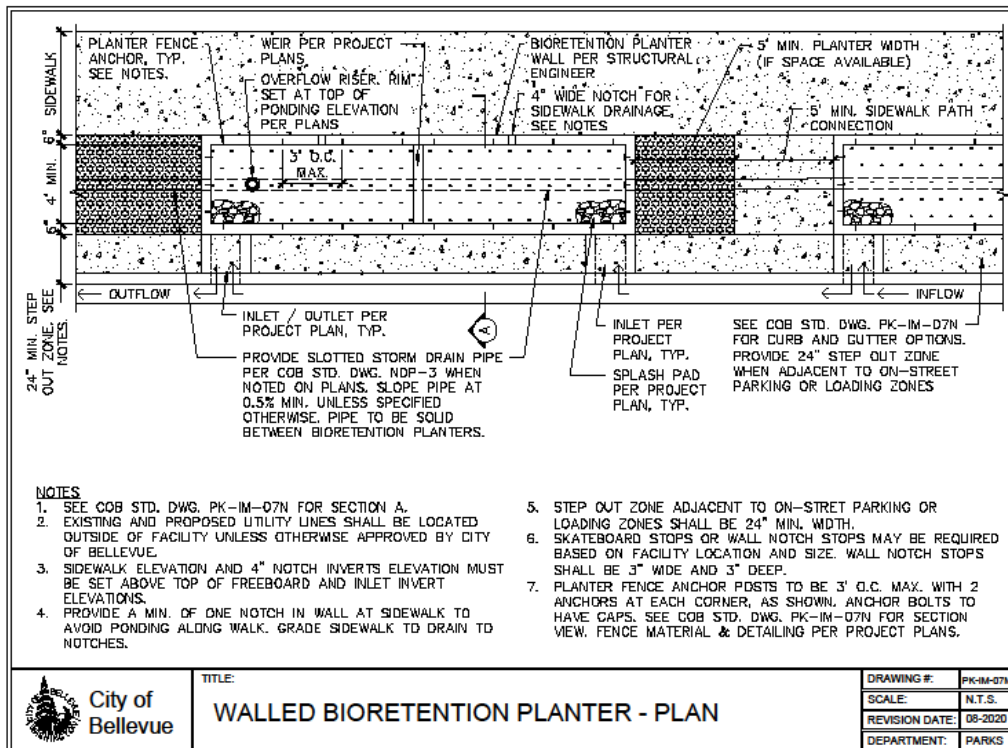

Standard detail revised with support of King Conservation District



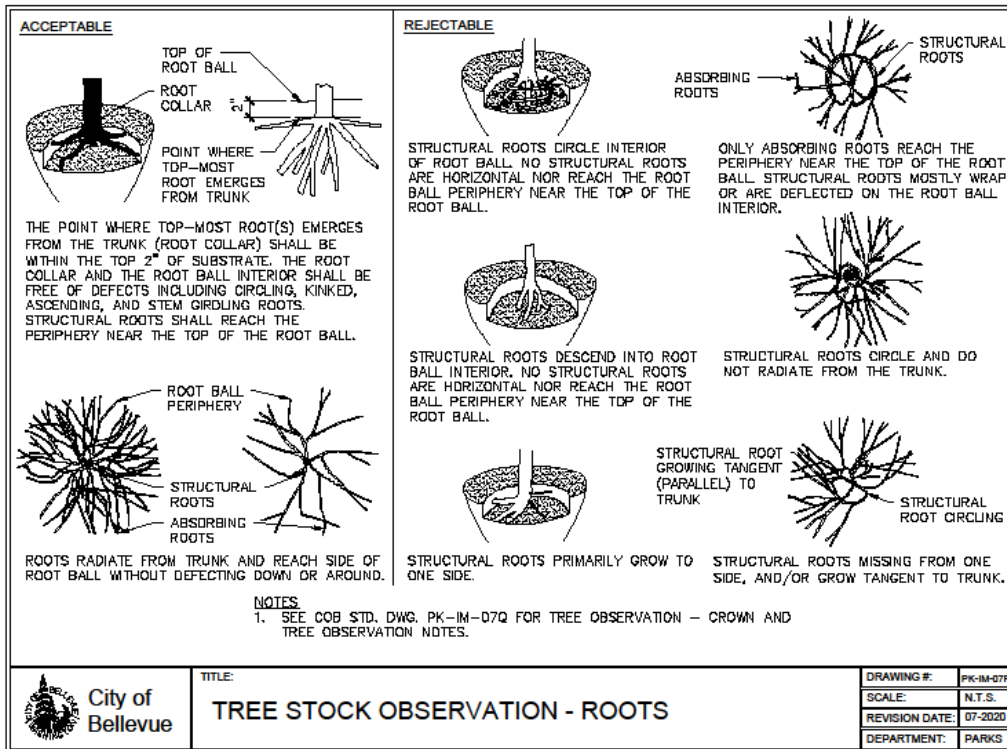

Standard detail revised with support of King Conservation District

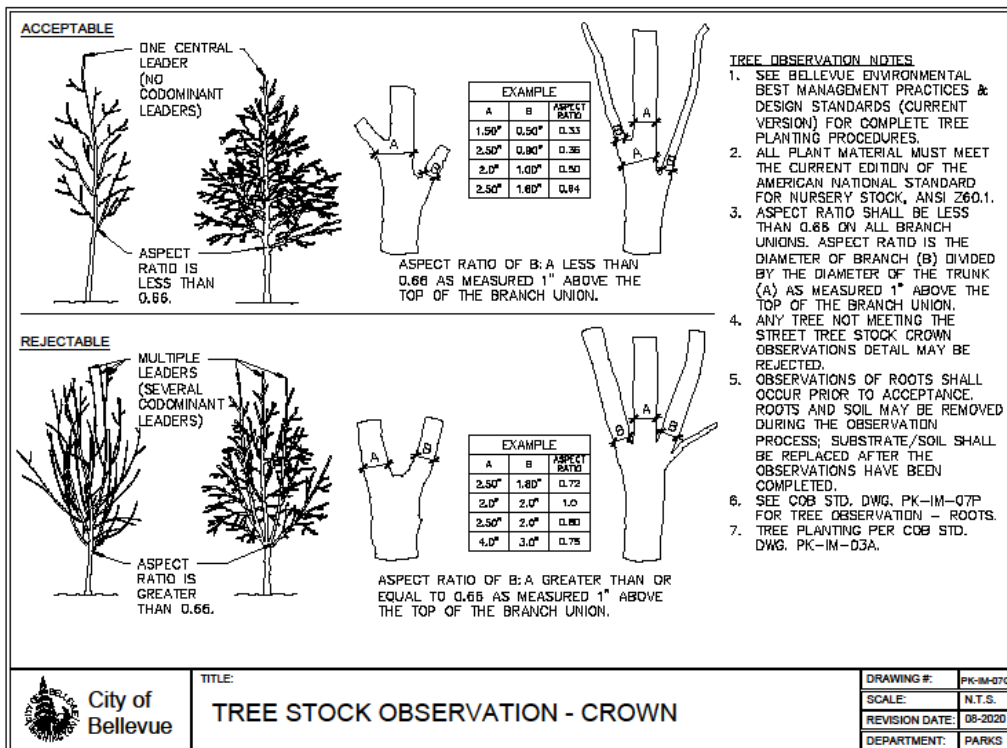

Standard detail revised with support of King Conservation District

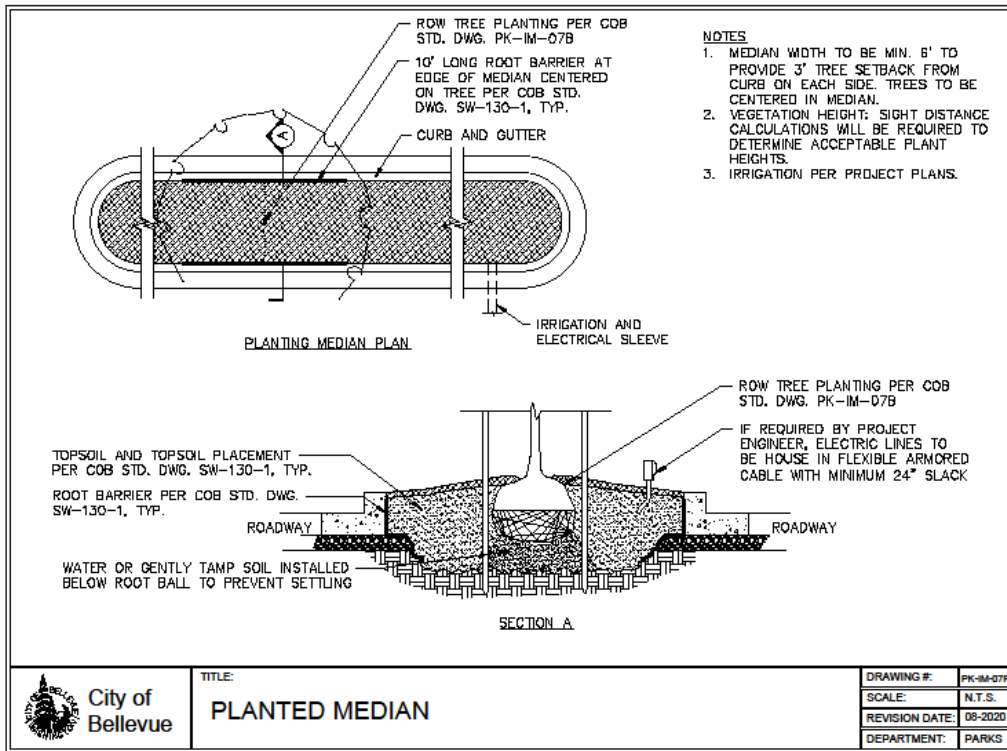

Standard detail revised with support of King Conservation District

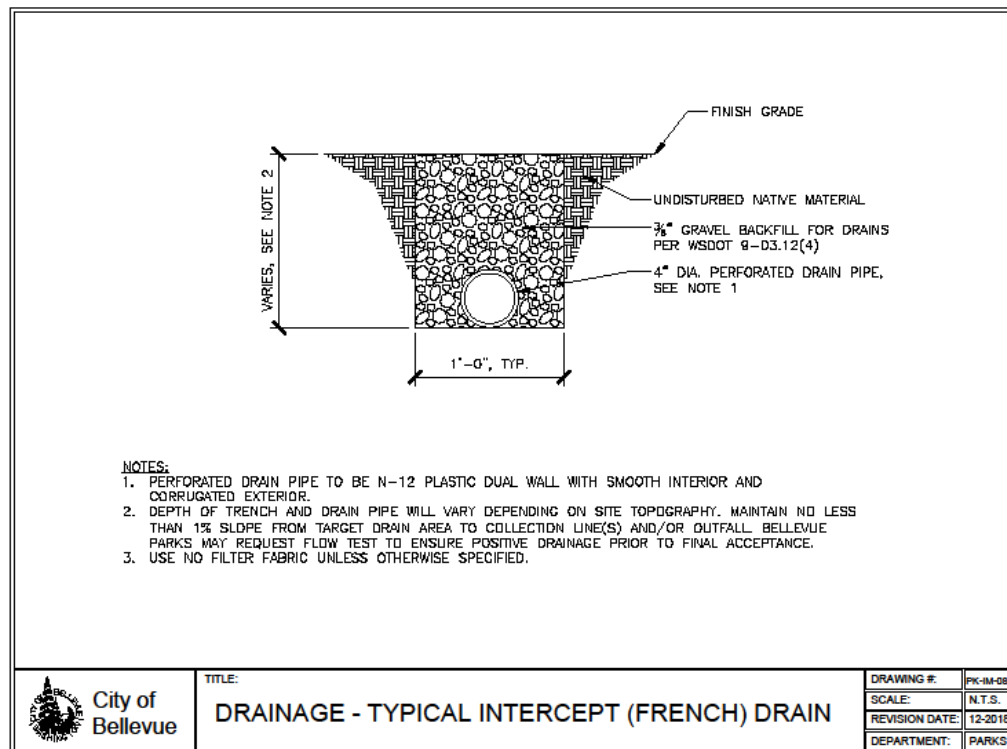

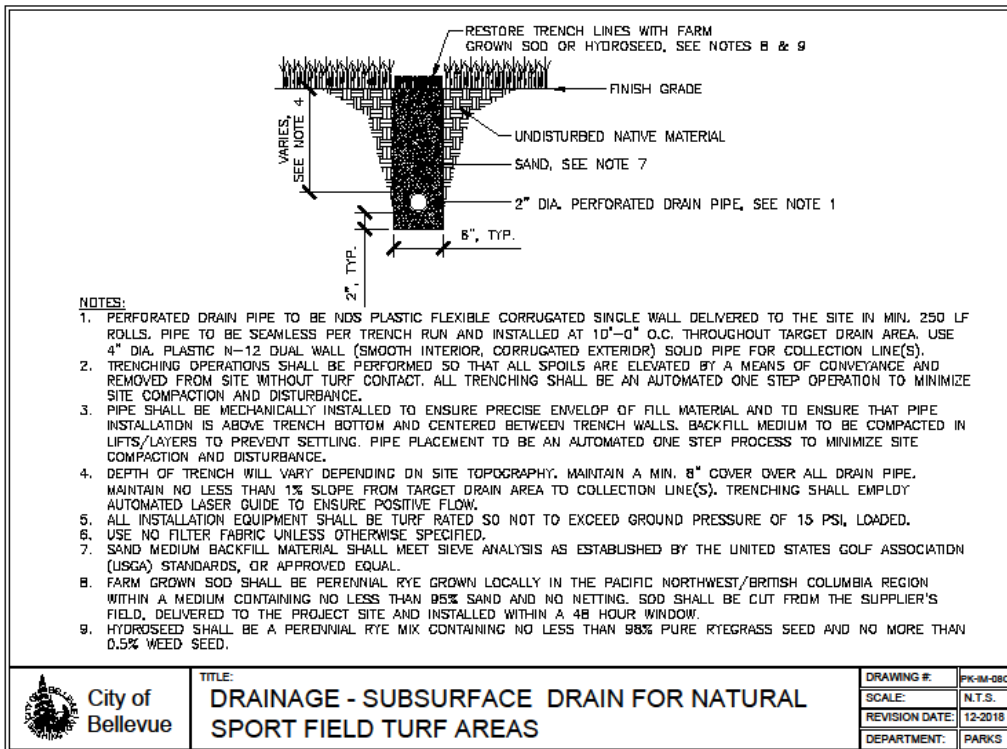
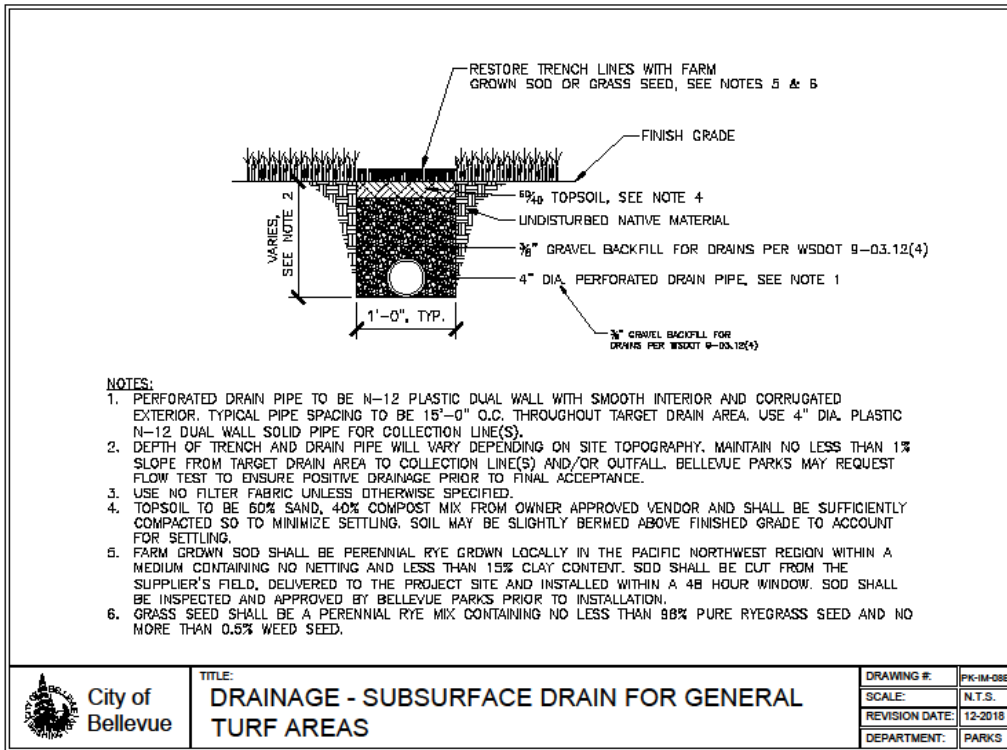



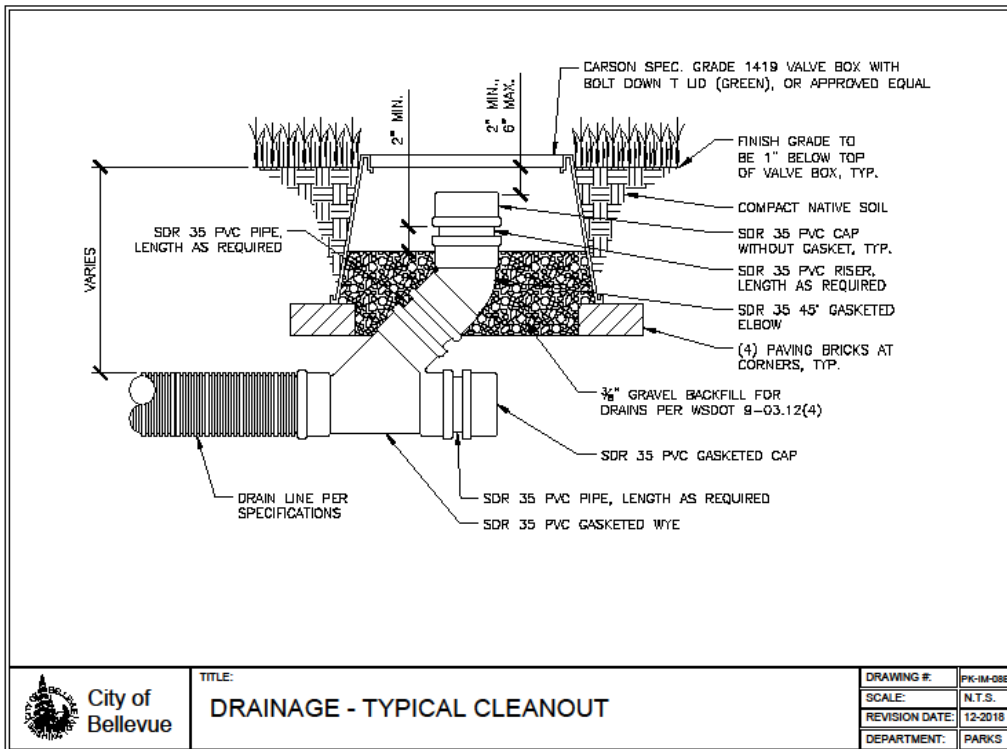
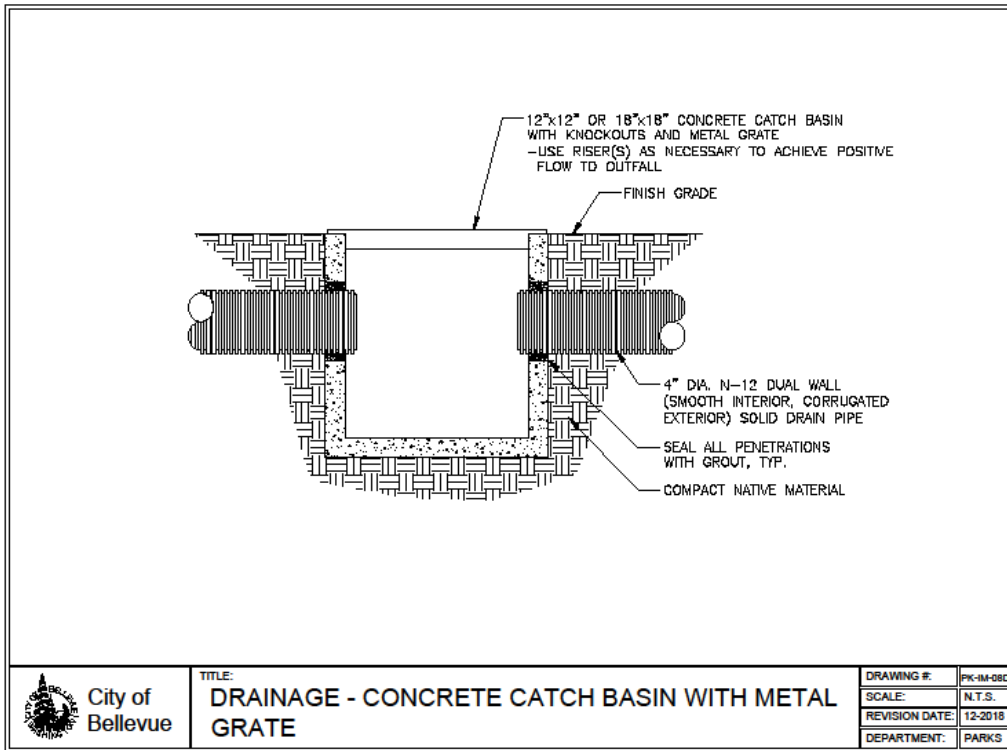

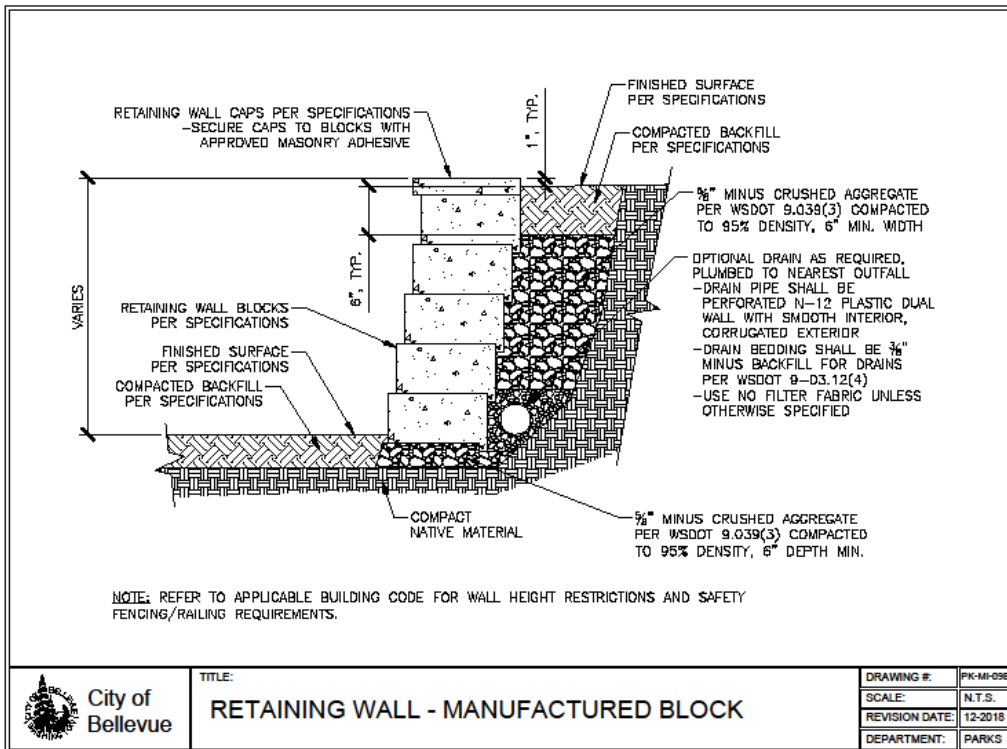
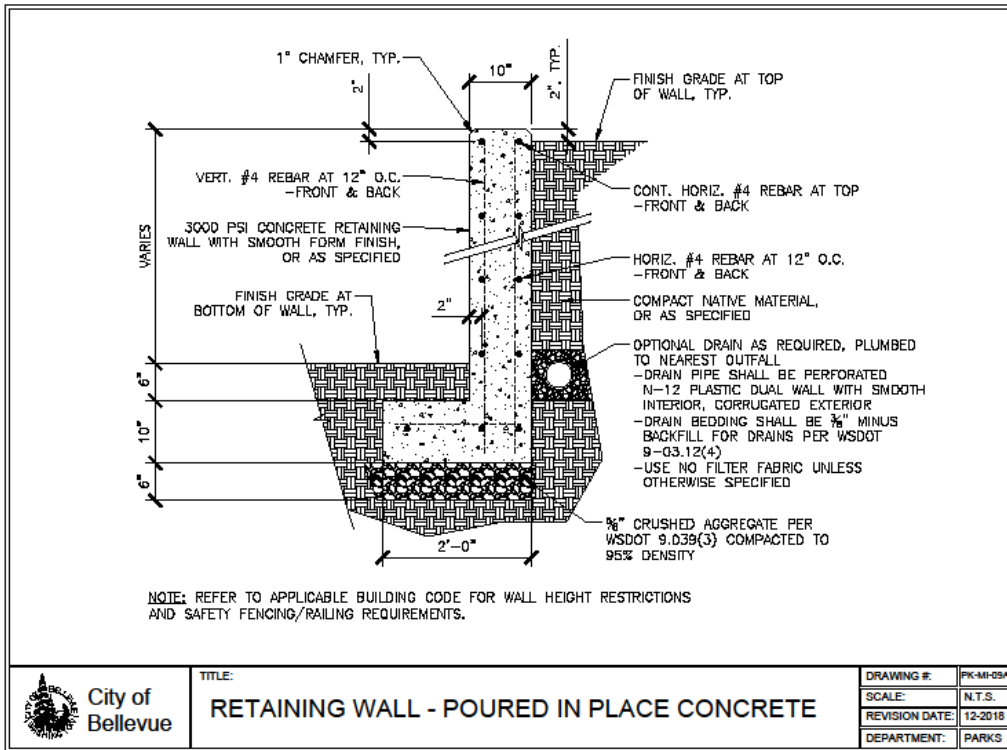

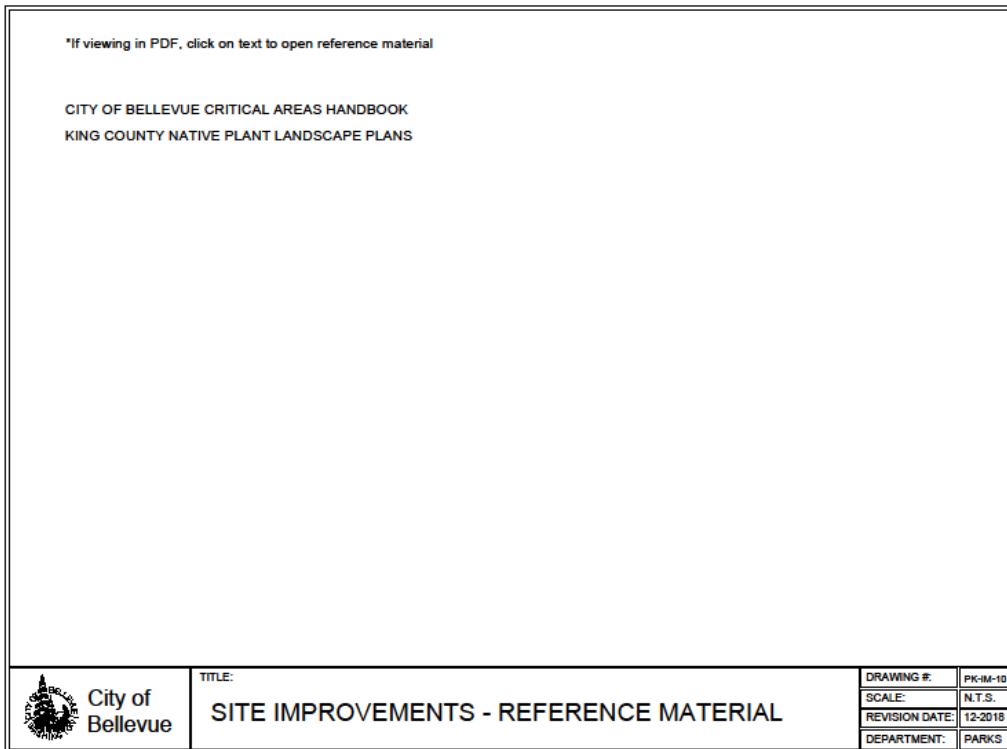
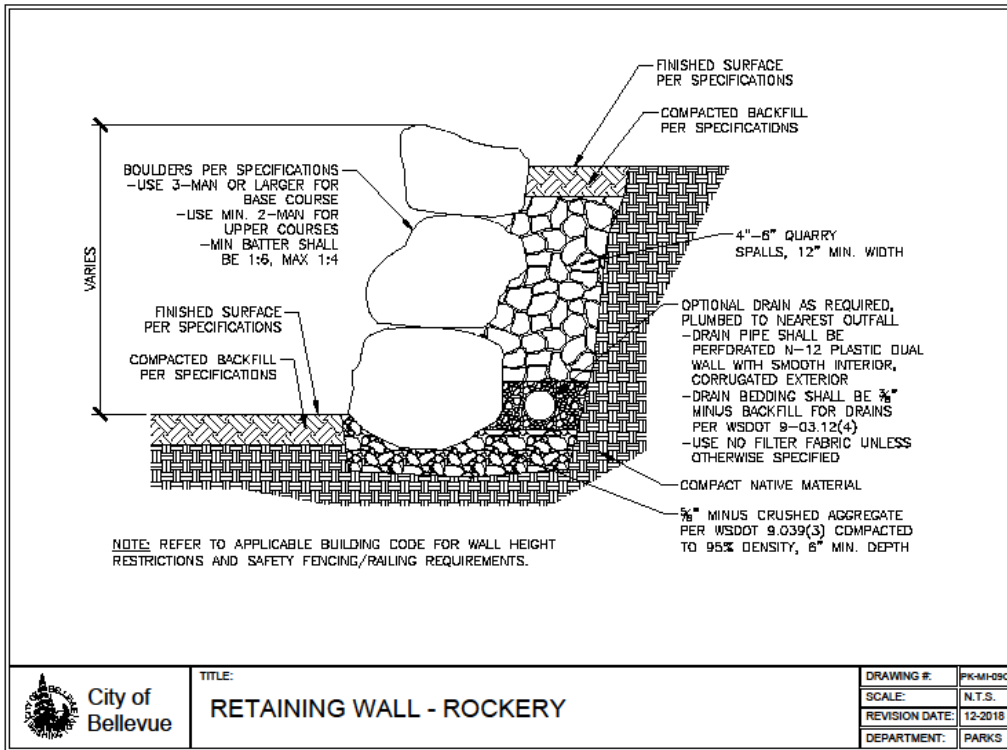

# Trails

---



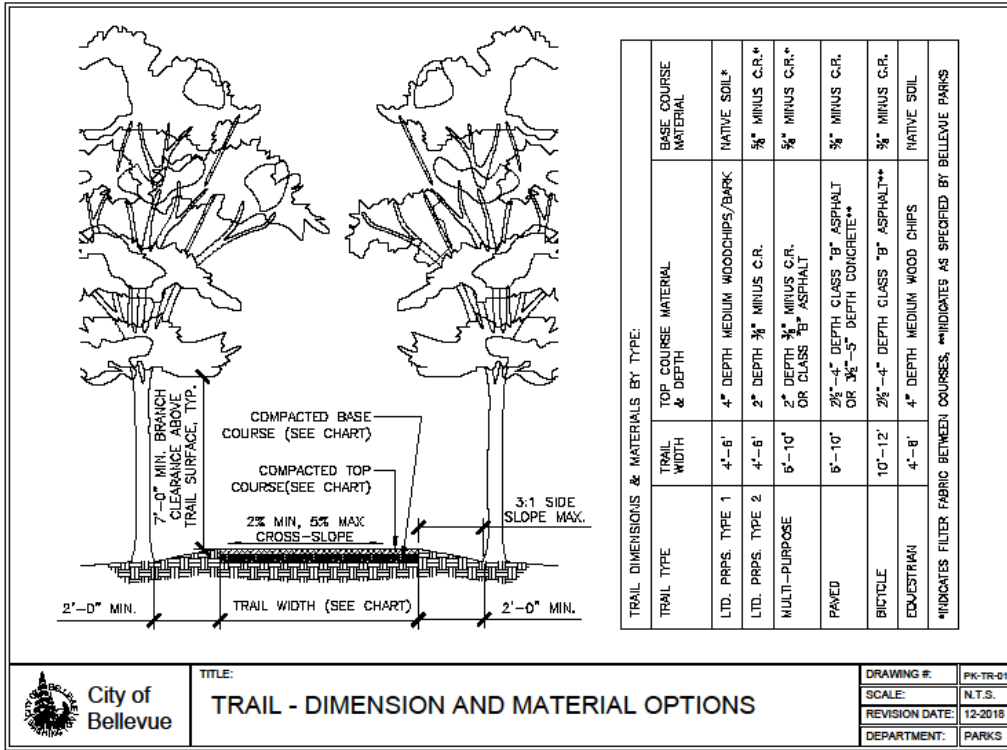

City of Bellevue

TITLE: TRAIL - DIMENSION AND MATERIAL OPTIONS

DRAWING #:	PK-TR-01
SCALE:	N.T.S.
REVISION DATE:	12-2018
DEPARTMENT:	PARKS

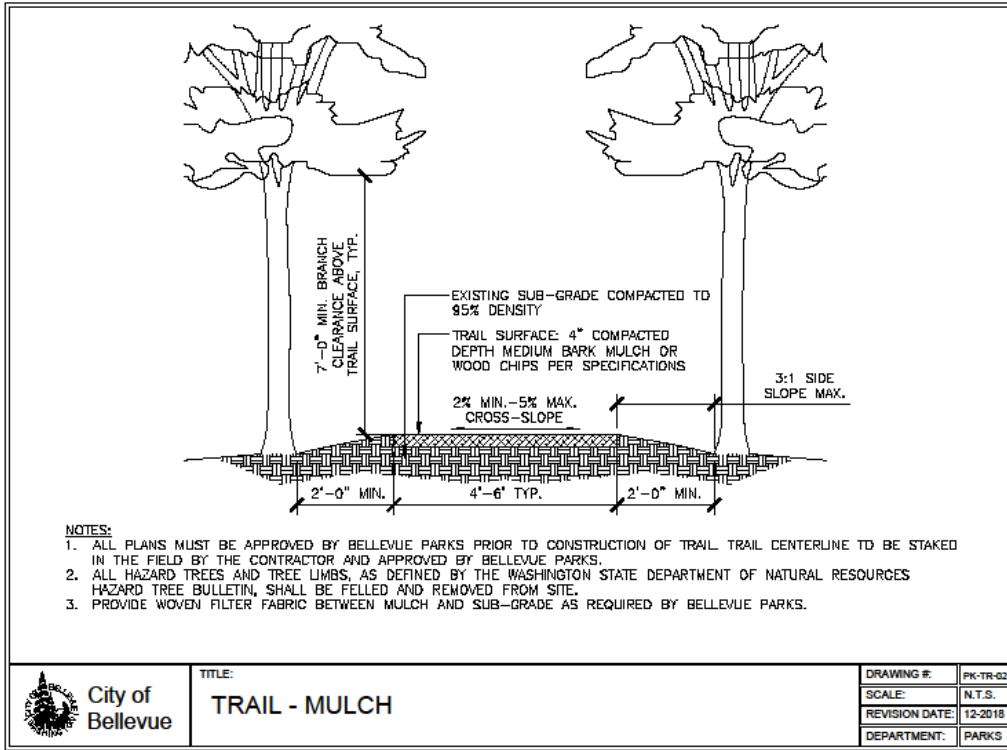

City of Bellevue

TITLE: TRAIL - MULCH

DRAWING #:	PK-TR-02
SCALE:	N.T.S.
REVISION DATE:	12-2018
DEPARTMENT:	PARKS

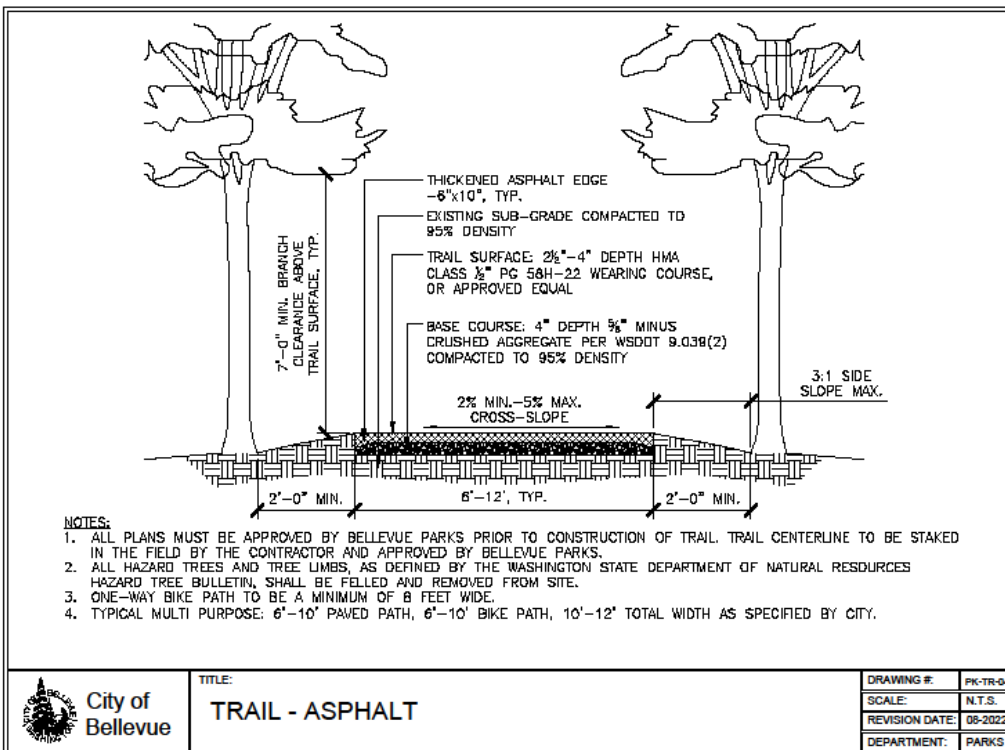
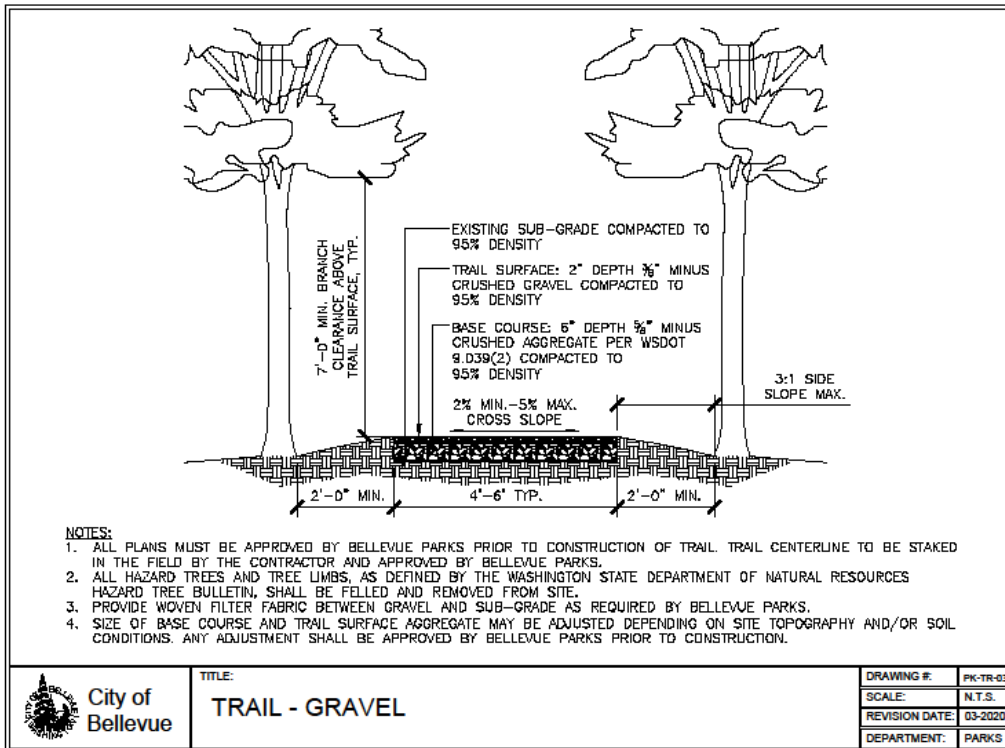

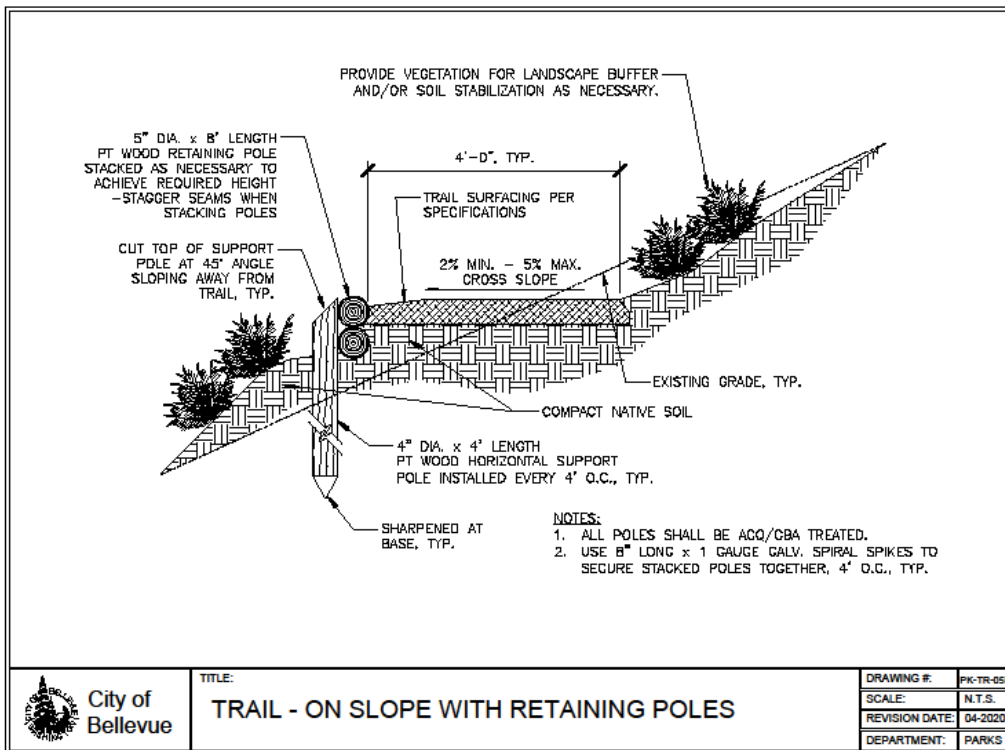
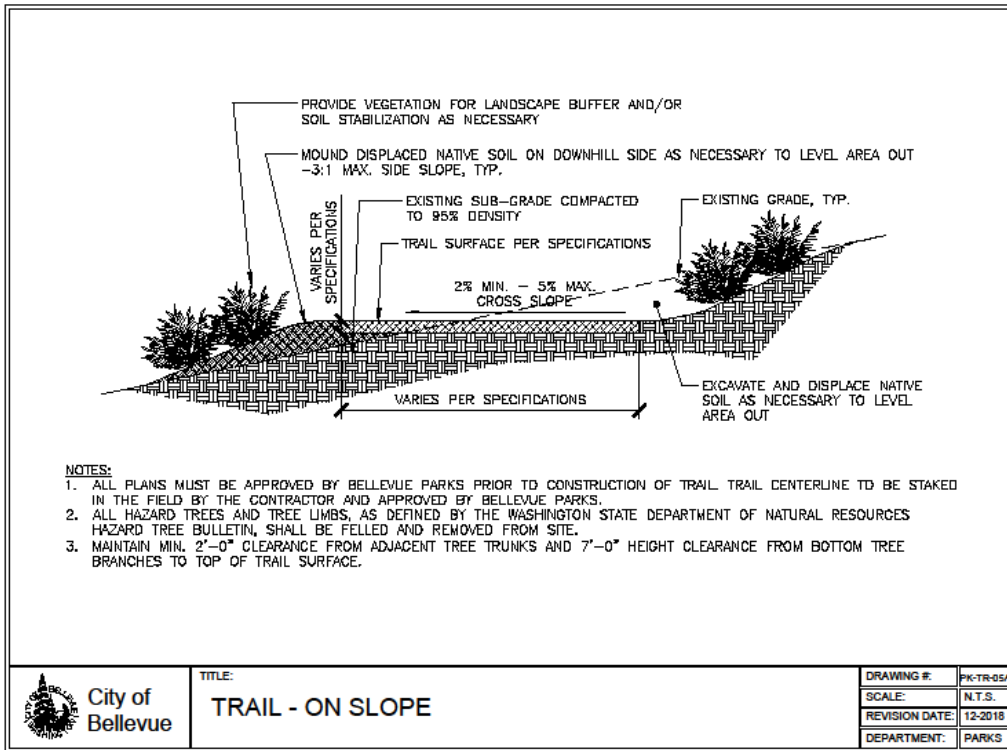

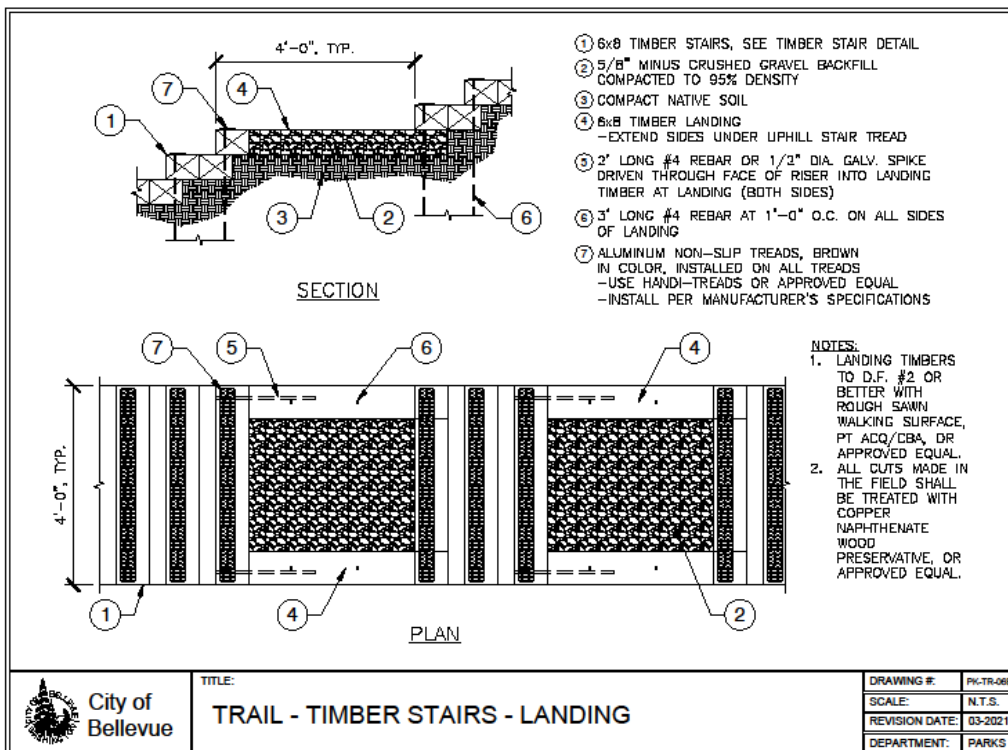
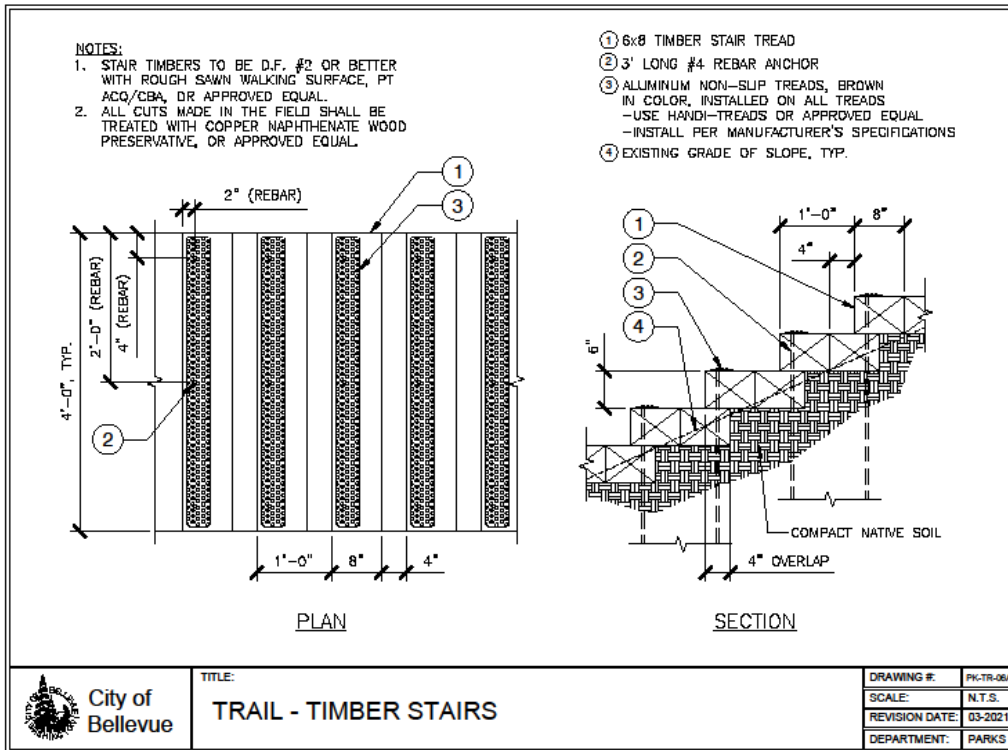



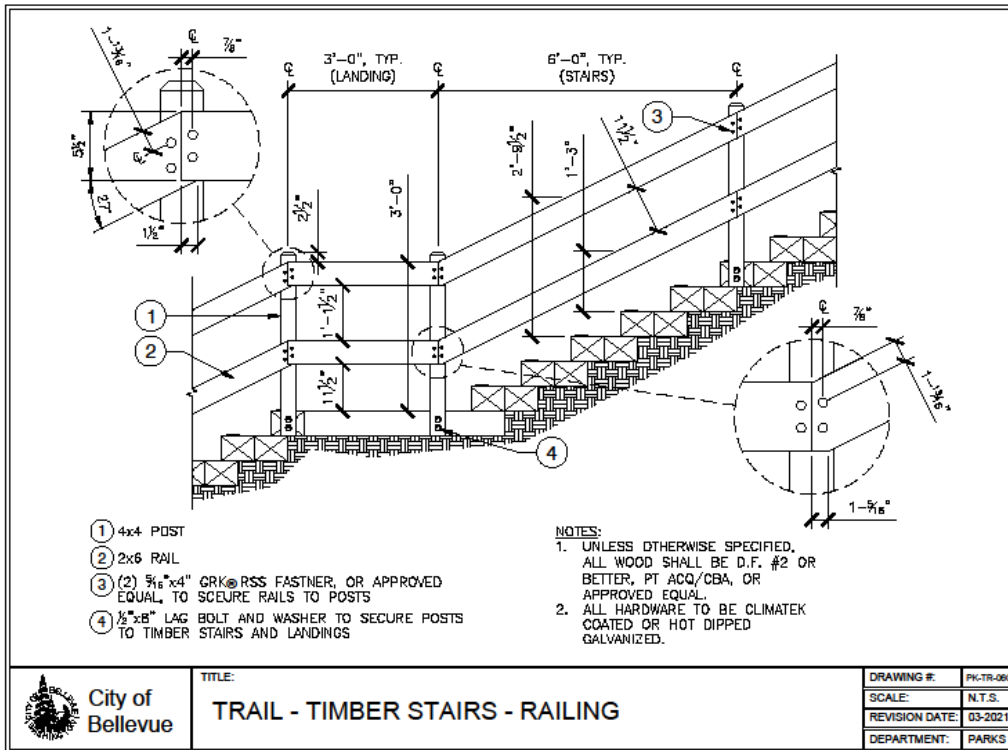

	TITLE:	DRAWING #:	PK-TR-06C
	TRAIL - TIMBER STAIRS - RAILING	SCALE:	N.T.S.
		REVISION DATE:	03-2021
		DEPARTMENT:	PARKS

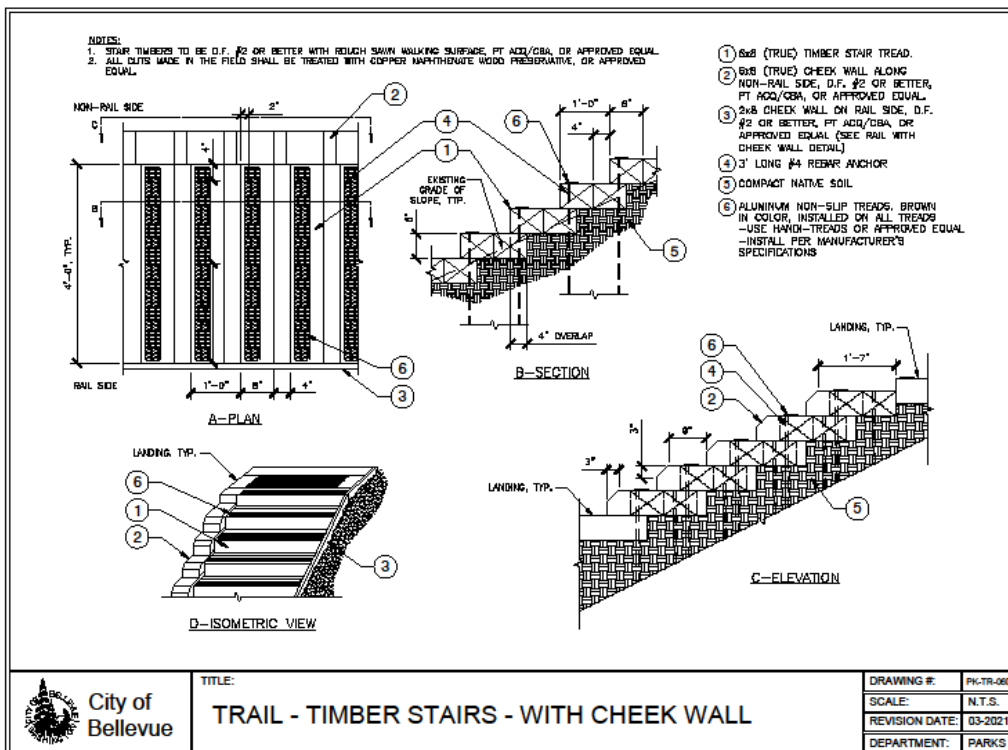

	TITLE:	DRAWING #:	PK-TR-06C
	TRAIL - TIMBER STAIRS - WITH CHEEK WALL	SCALE:	N.T.S.
		REVISION DATE:	03-2021
		DEPARTMENT:	PARKS

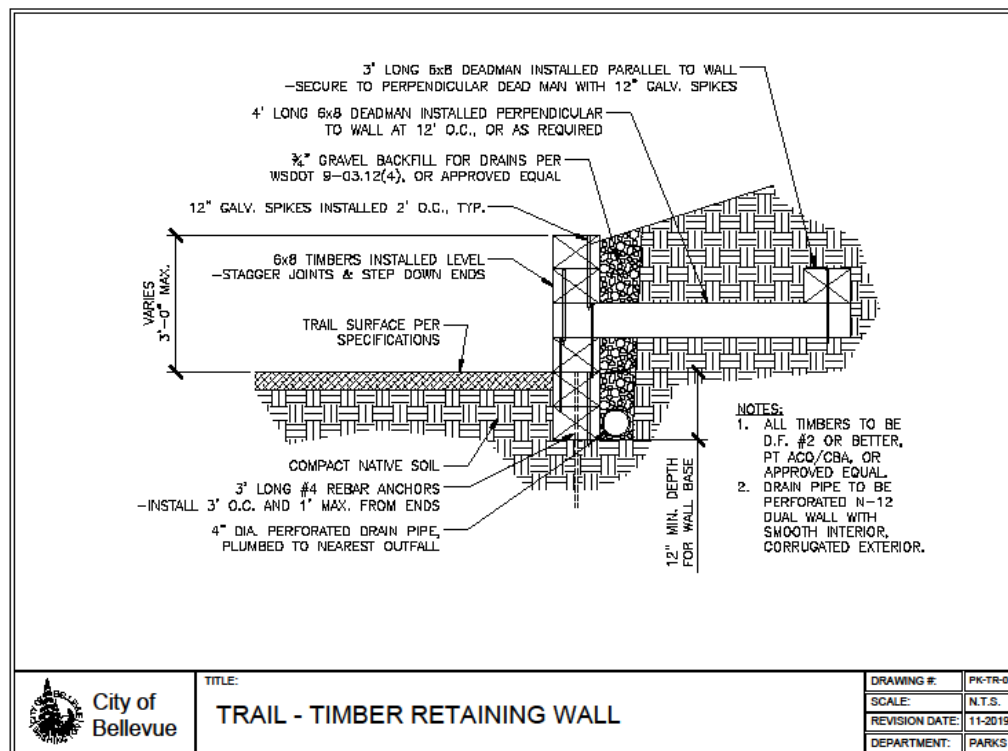
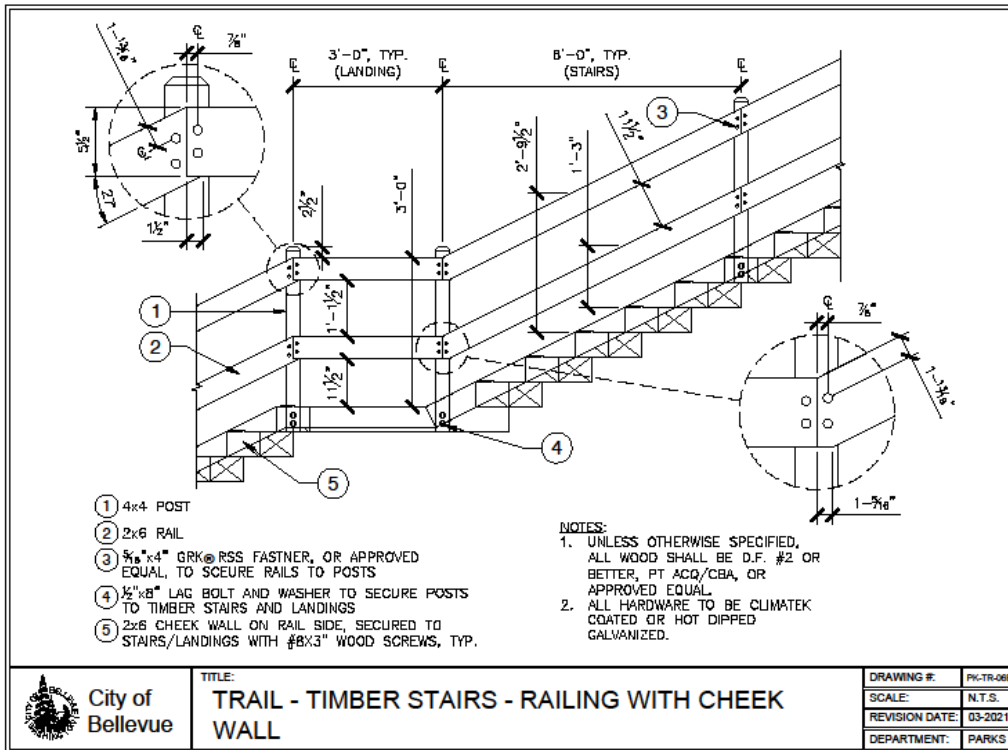

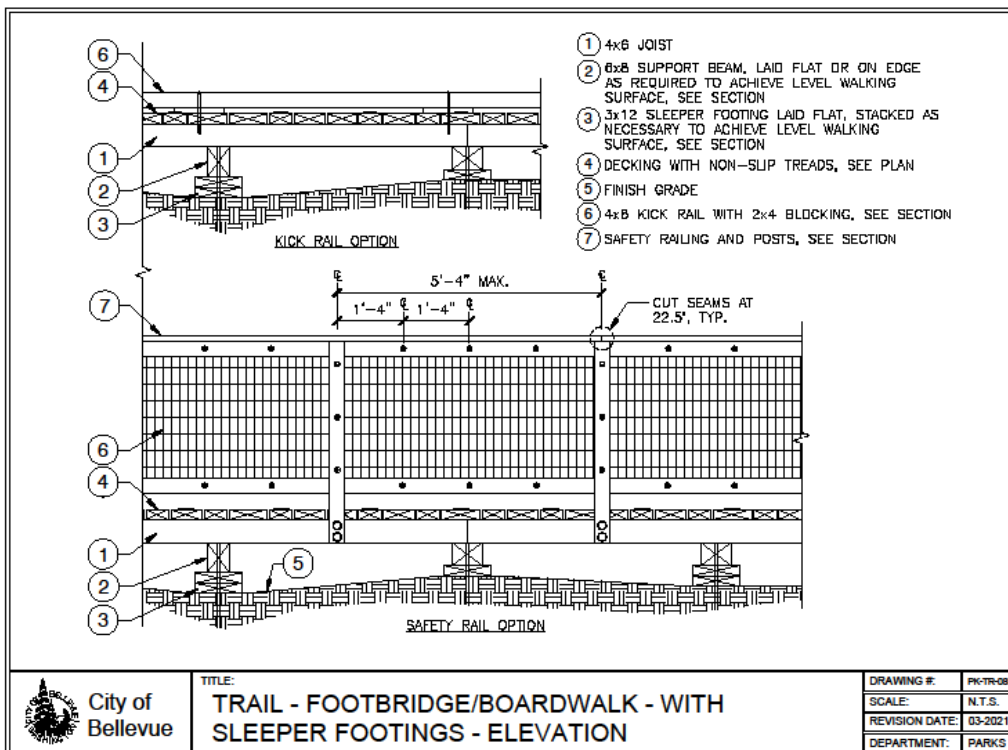
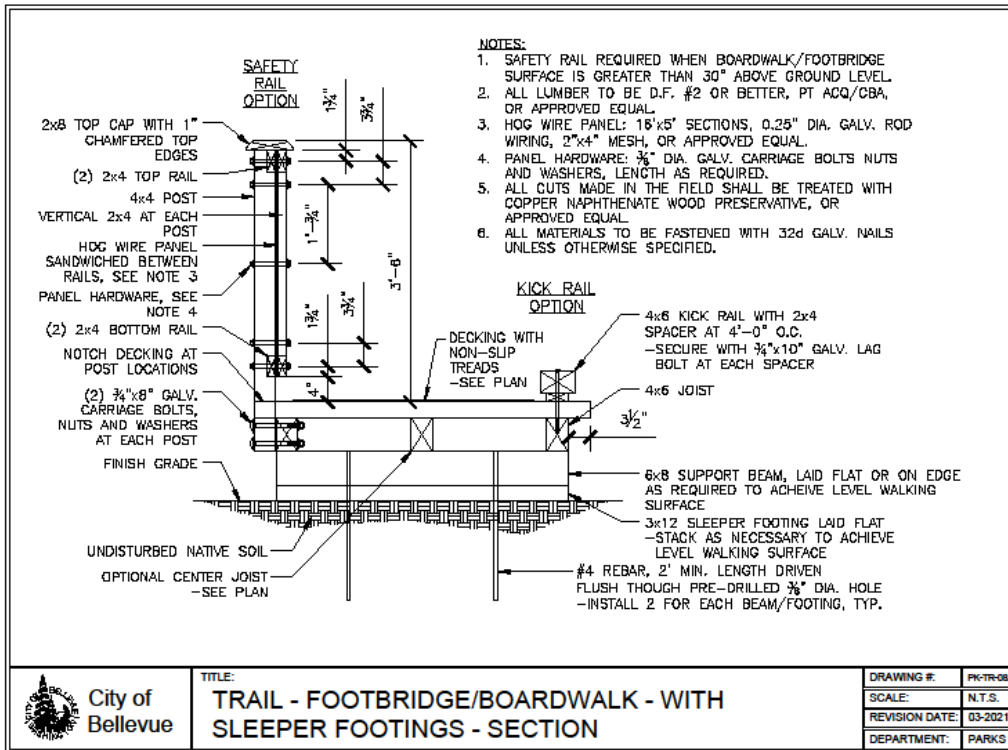

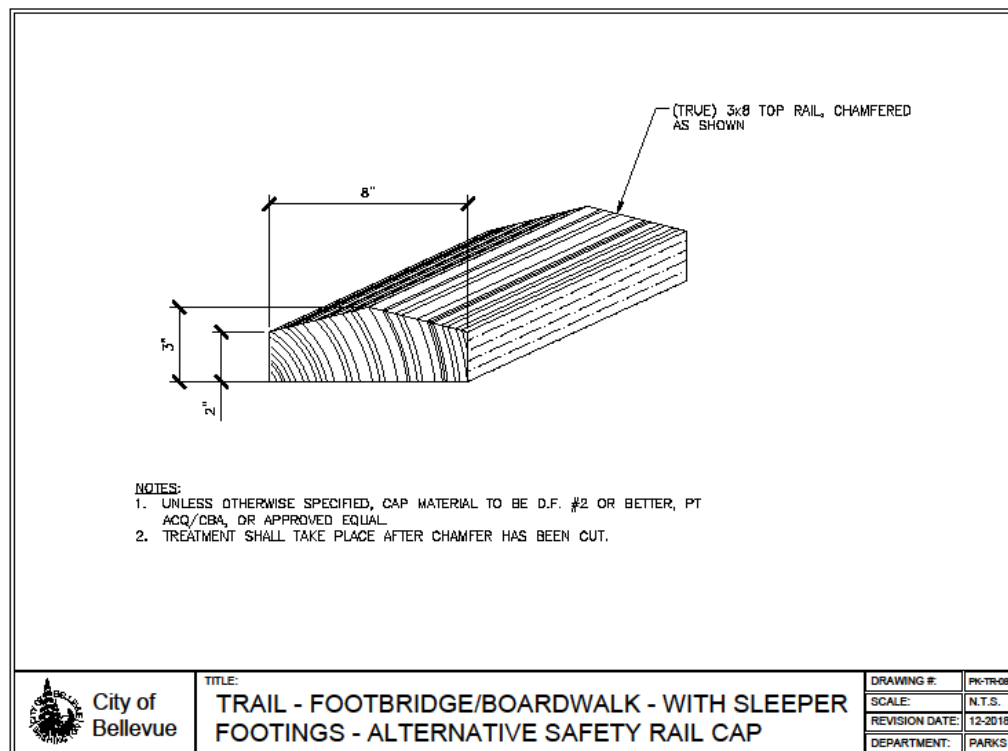
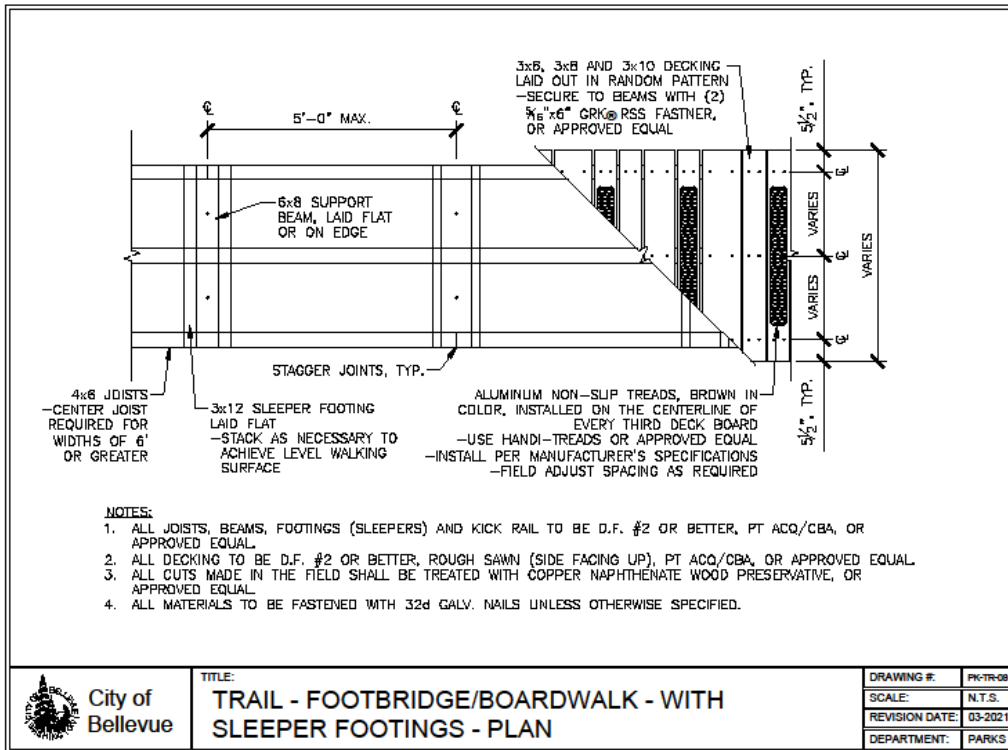

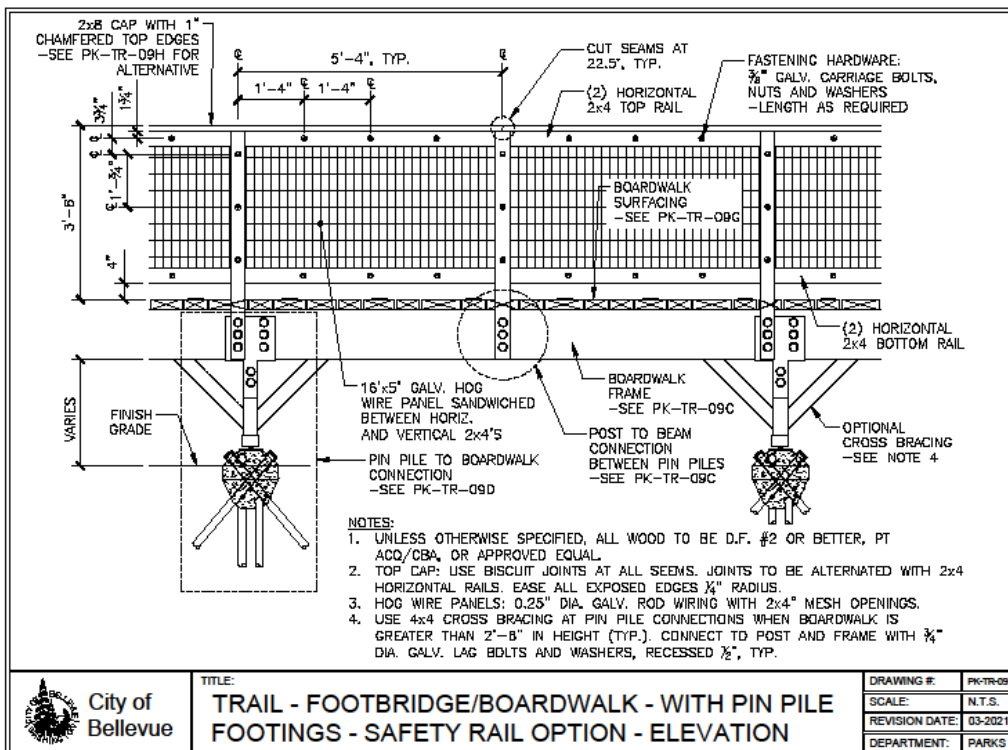
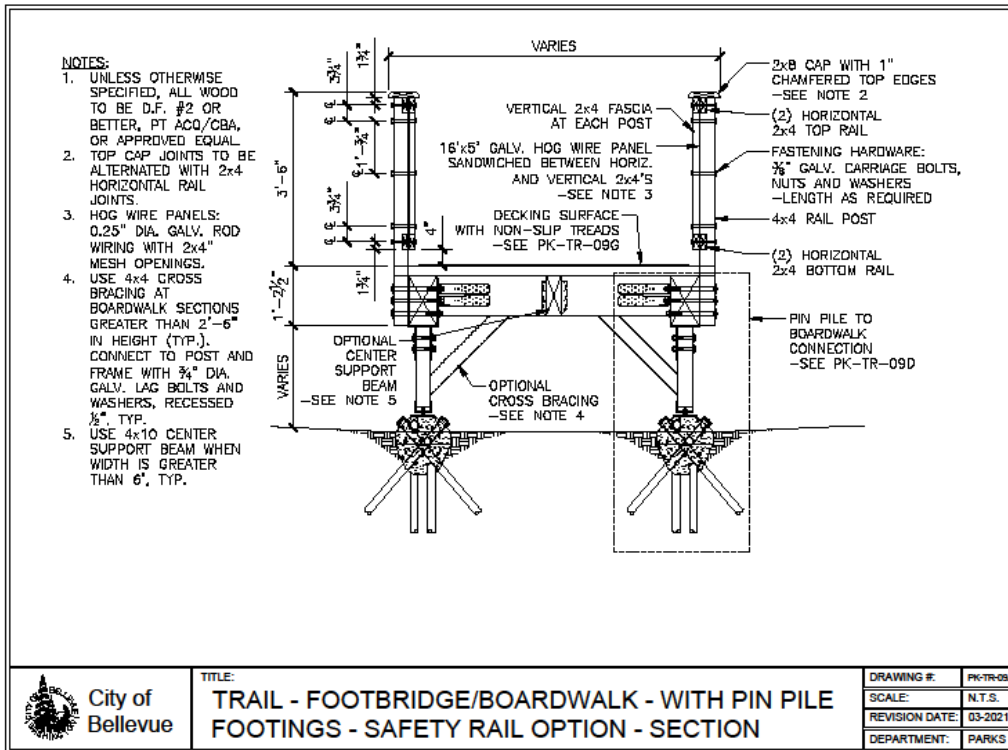

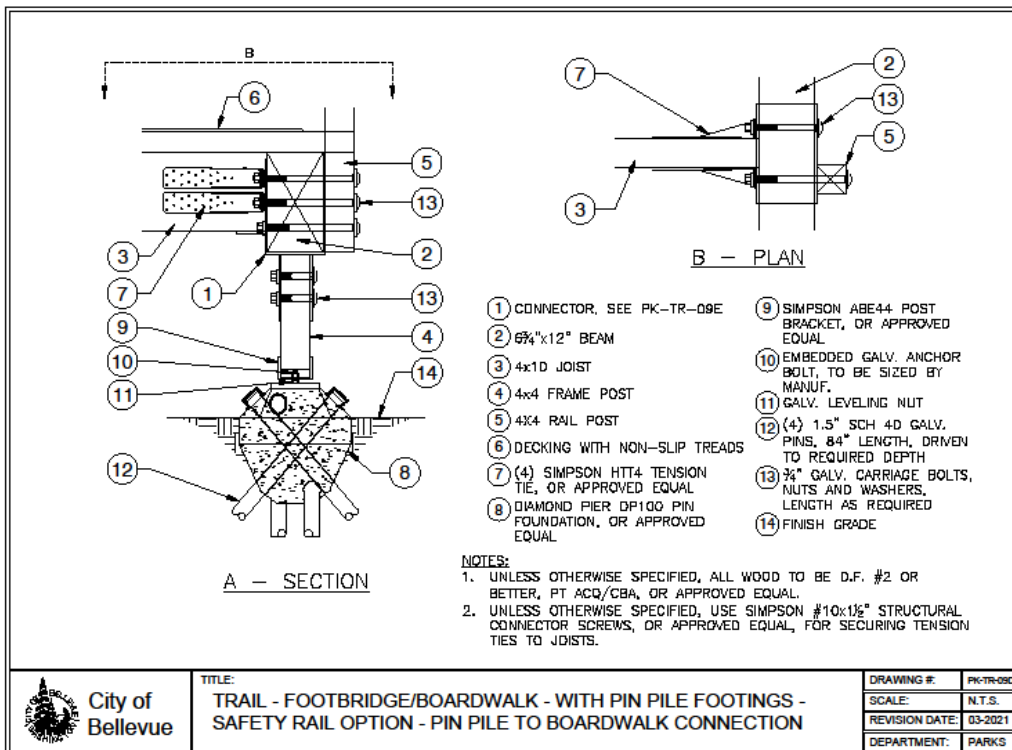
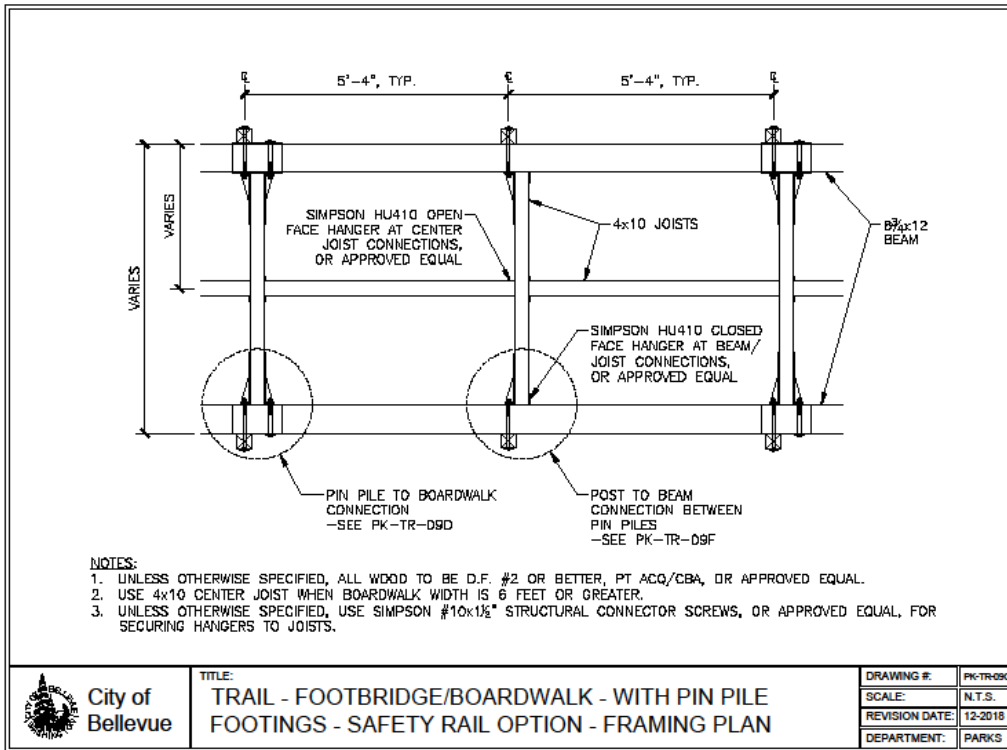

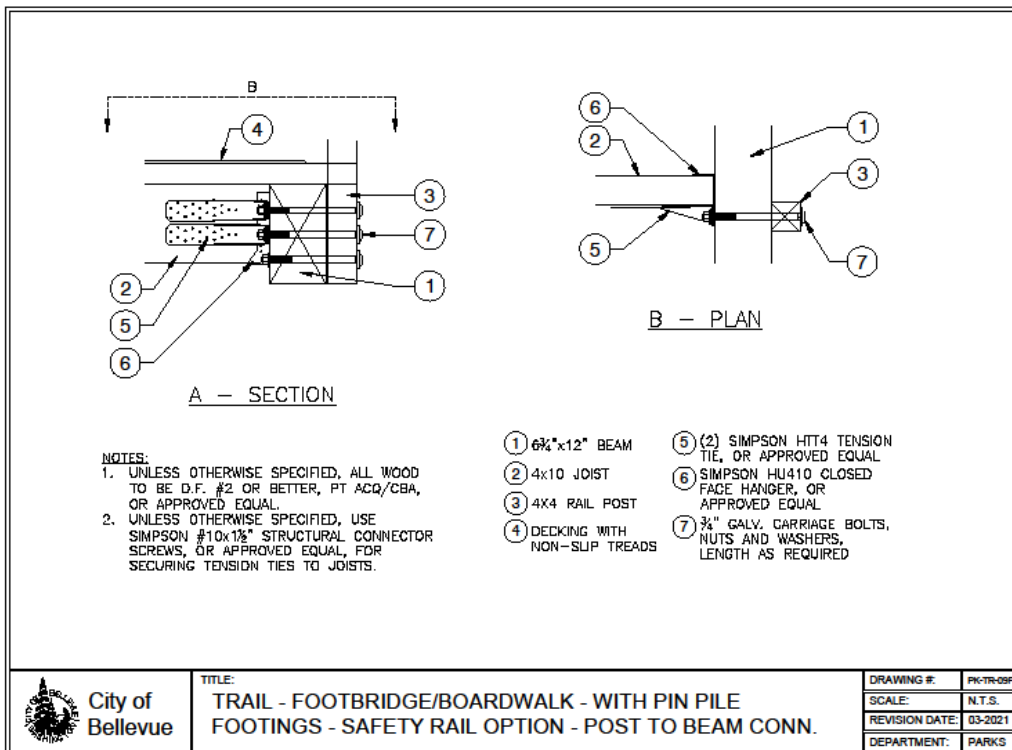
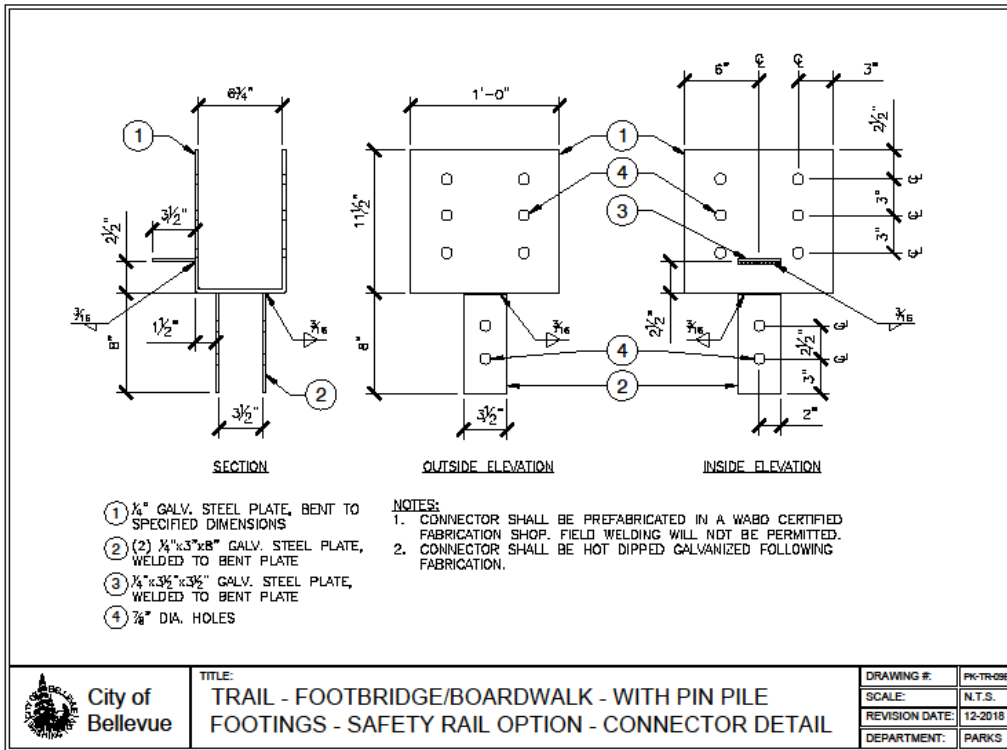

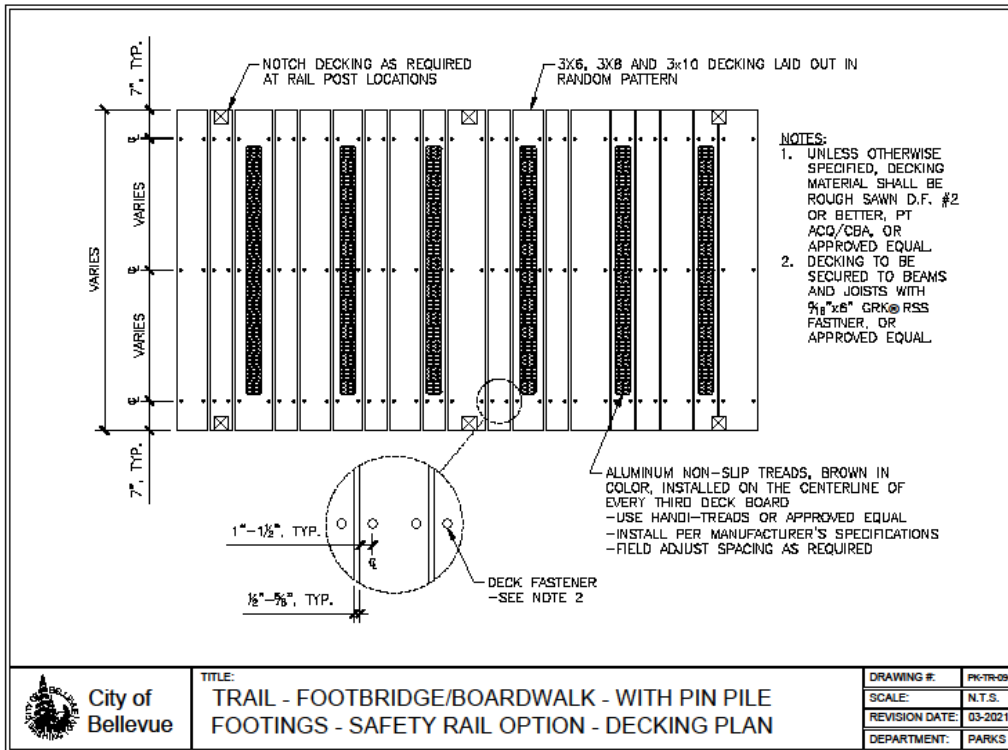

City of Bellevue

TITLE:  
TRAIL - FOOTBRIDGE/BOARDWALK - WITH PIN PILE FOOTINGS - SAFETY RAIL OPTION - DECKING PLAN

DRAWING #:	PK-TR-090
SCALE:	N.T.S.
REVISION DATE:	03-2021
DEPARTMENT:	PARKS

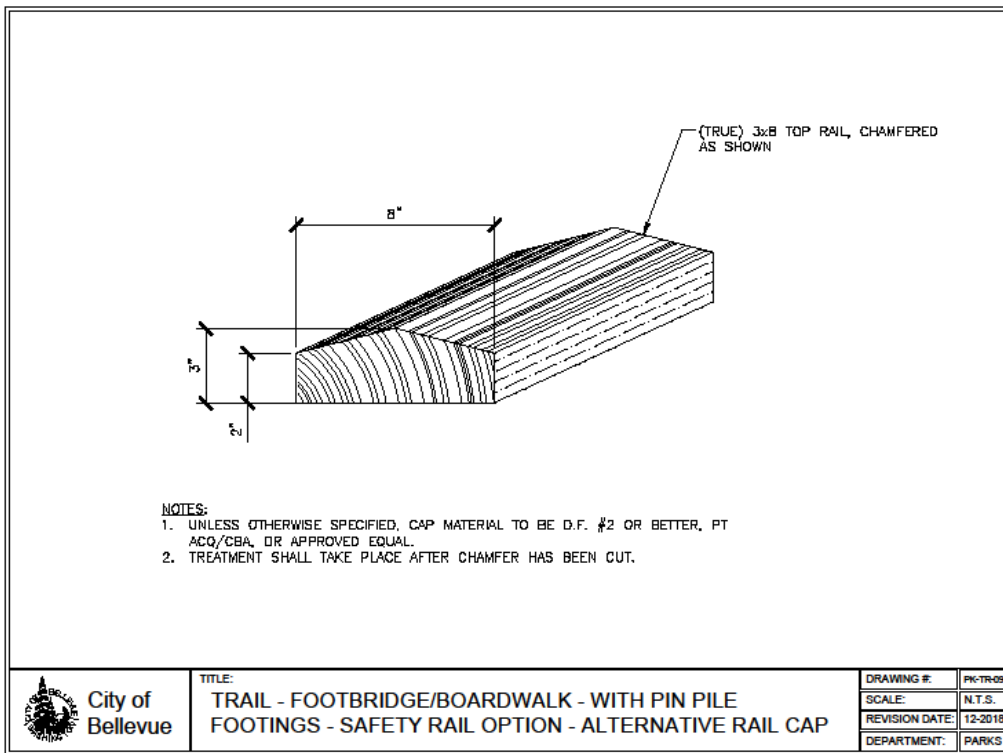

City of Bellevue

TITLE:  
TRAIL - FOOTBRIDGE/BOARDWALK - WITH PIN PILE FOOTINGS - SAFETY RAIL OPTION - ALTERNATIVE RAIL CAP

DRAWING #:	PK-TR-090H
SCALE:	N.T.S.
REVISION DATE:	12-2018
DEPARTMENT:	PARKS



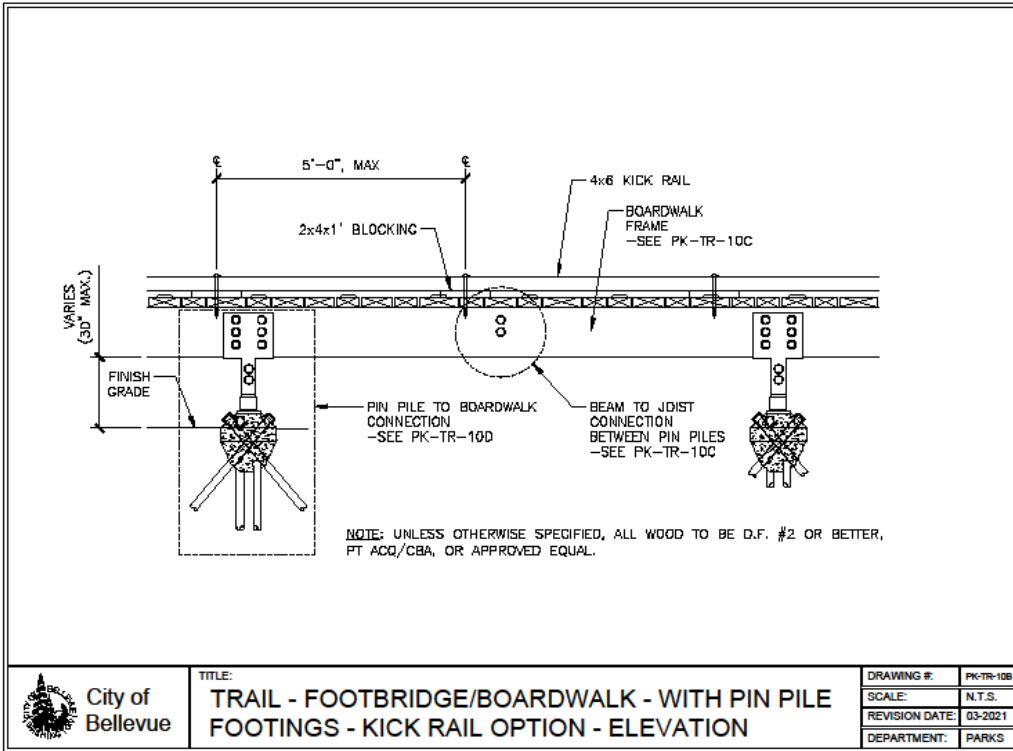
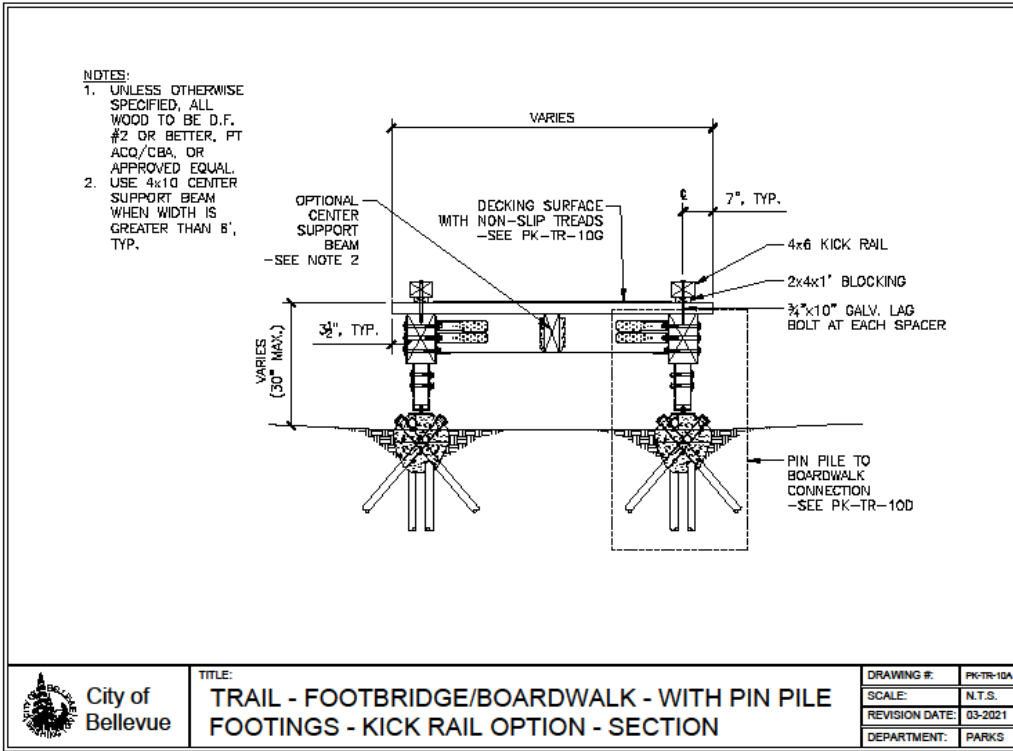

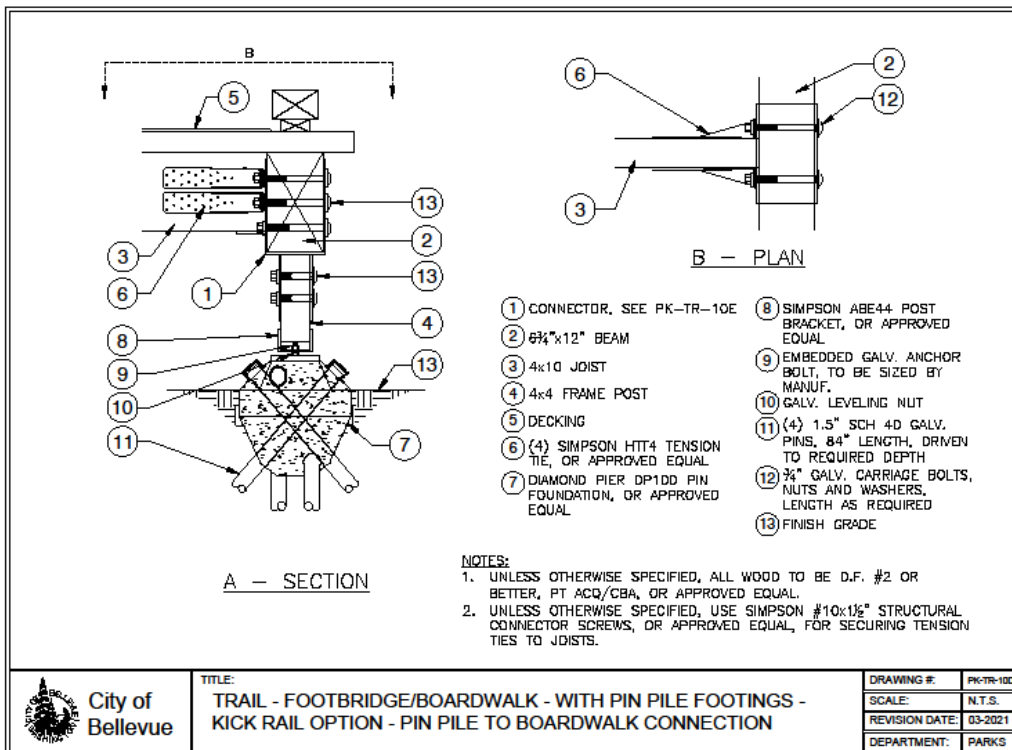
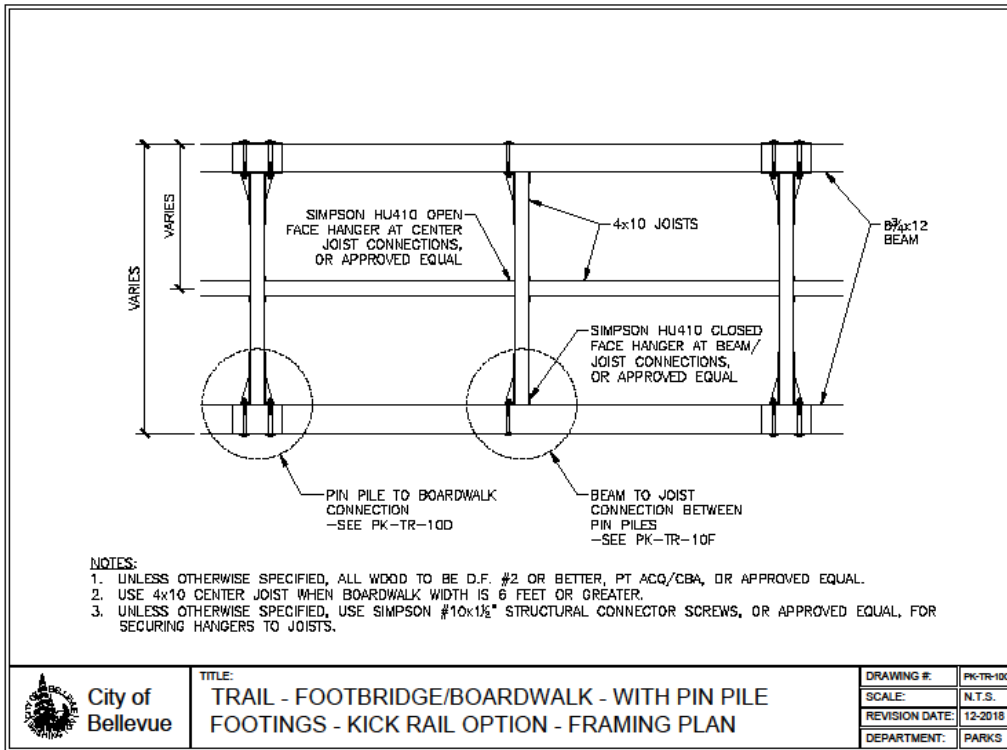

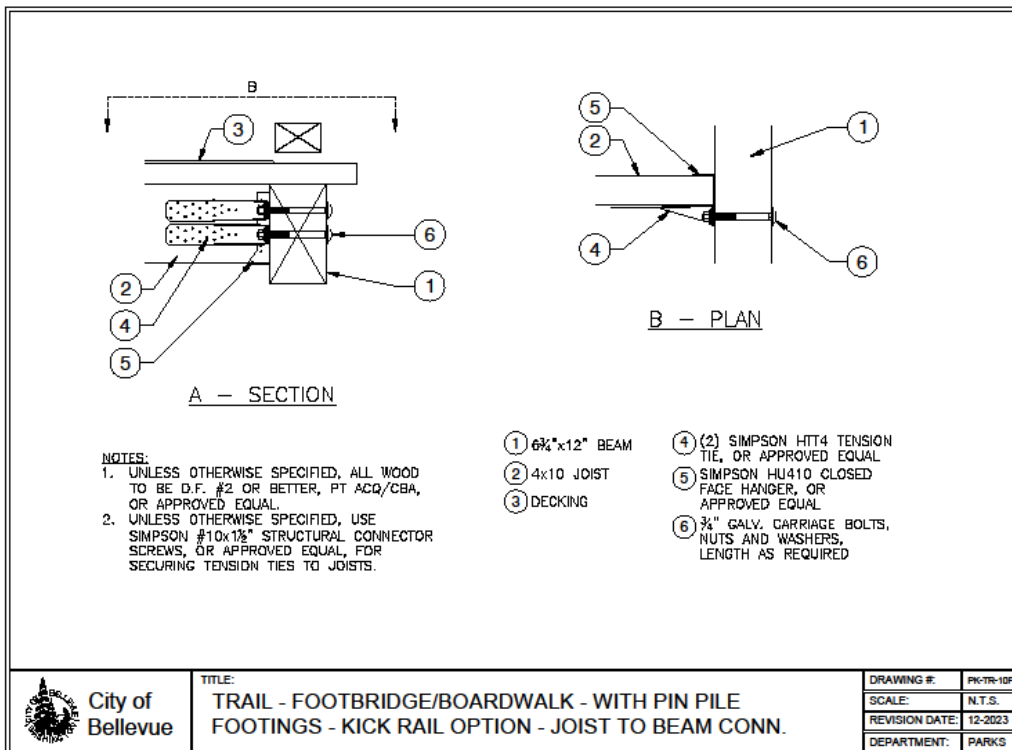
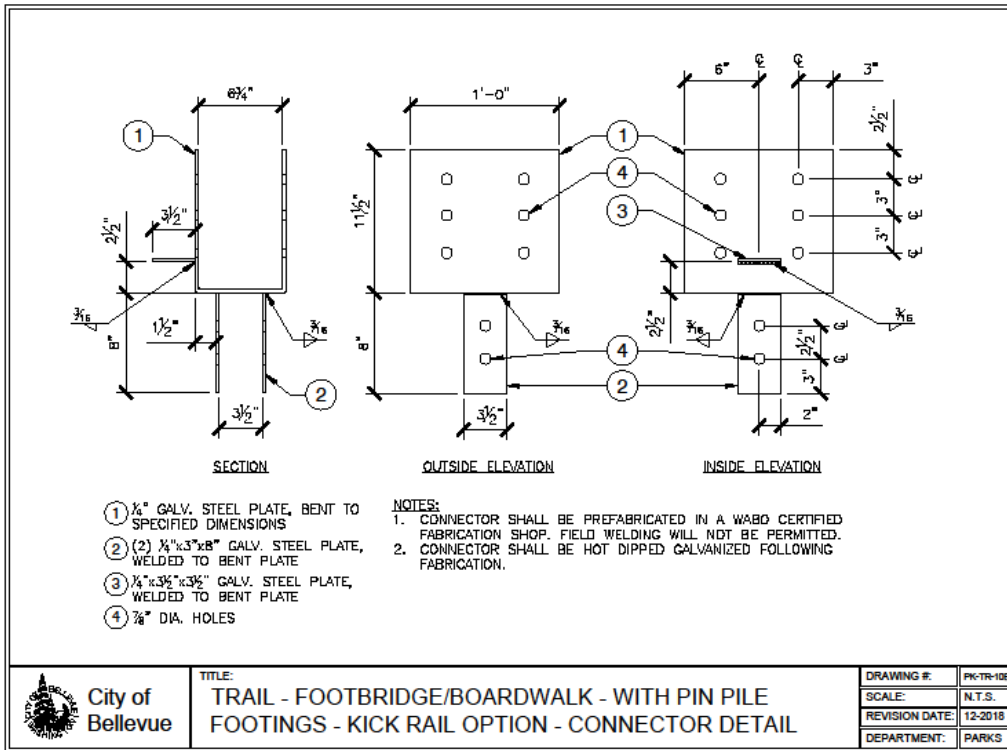

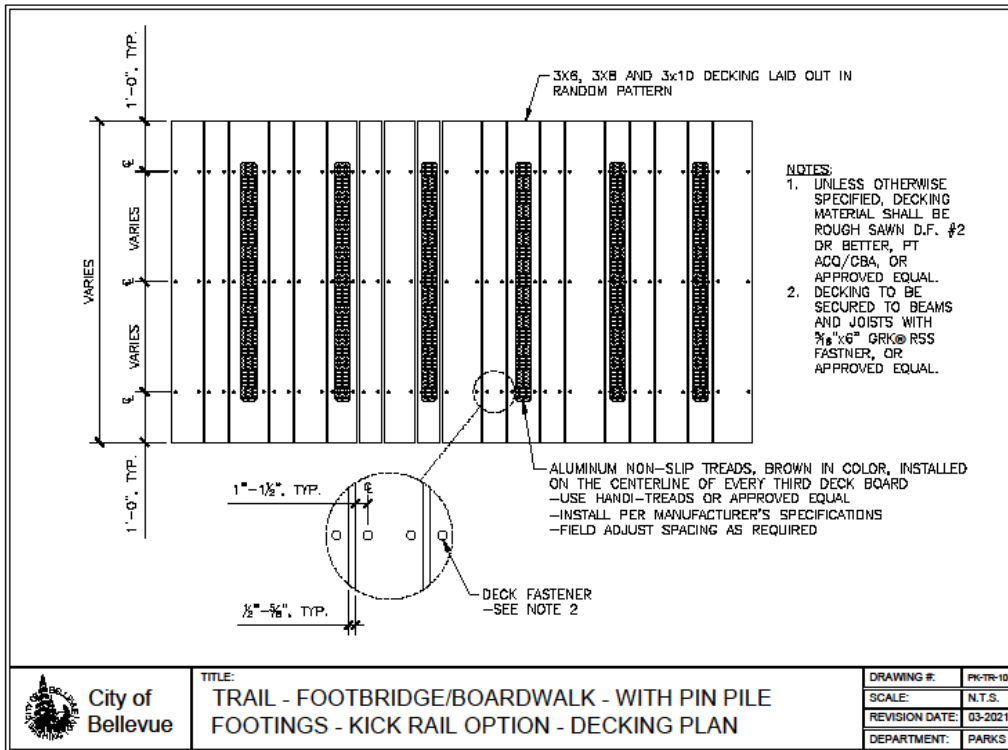

City of Bellevue

TITLE: TRAIL - FOOTBRIDGE/BOARDWALK - WITH PIN PILE FOOTINGS - KICK RAIL OPTION - DECKING PLAN

DRAWING #:	PK-TR-100
SCALE:	N.T.S.
REVISION DATE:	03-2021
DEPARTMENT:	PARKS

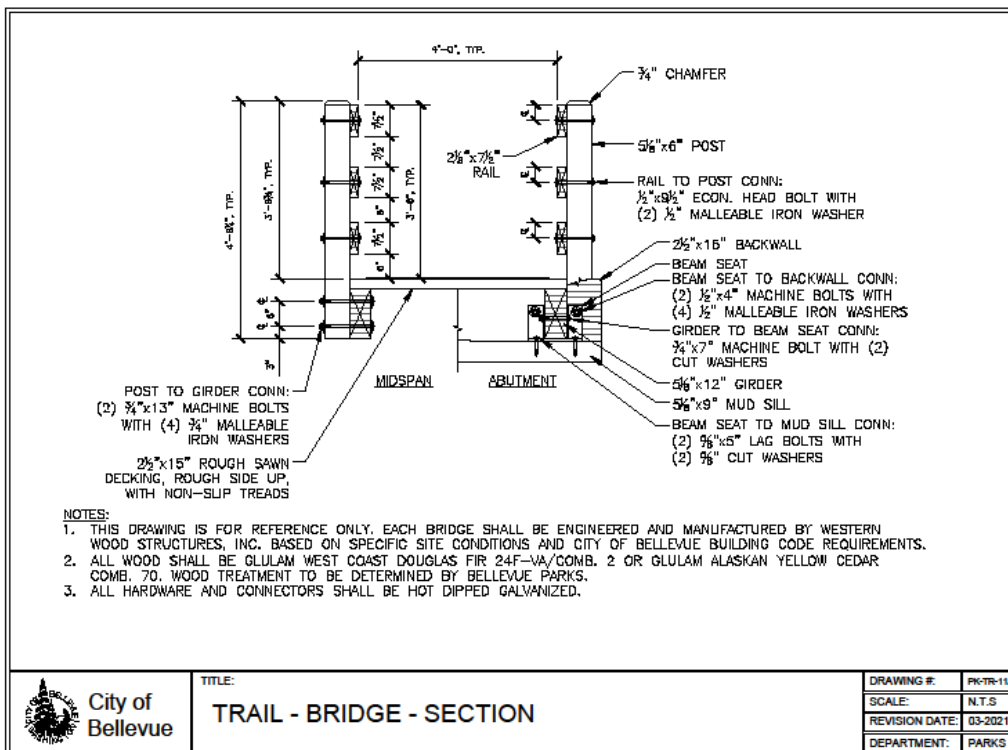

City of Bellevue

TITLE: TRAIL - BRIDGE - SECTION

DRAWING #:	PK-TR-11A
SCALE:	N.T.S.
REVISION DATE:	03-2021
DEPARTMENT:	PARKS

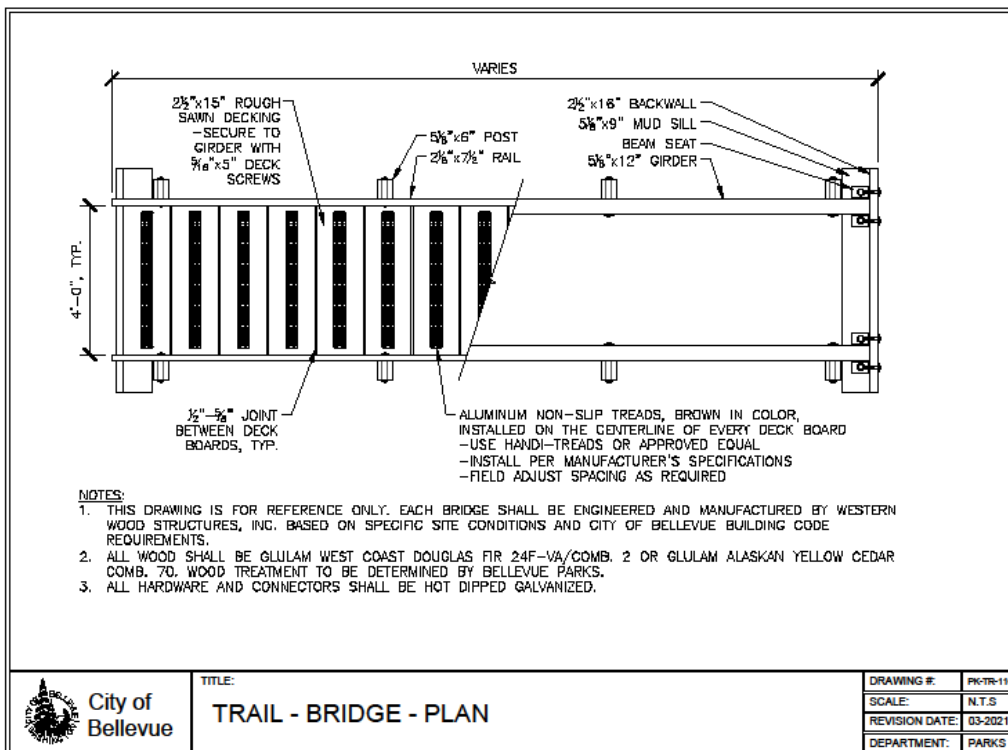
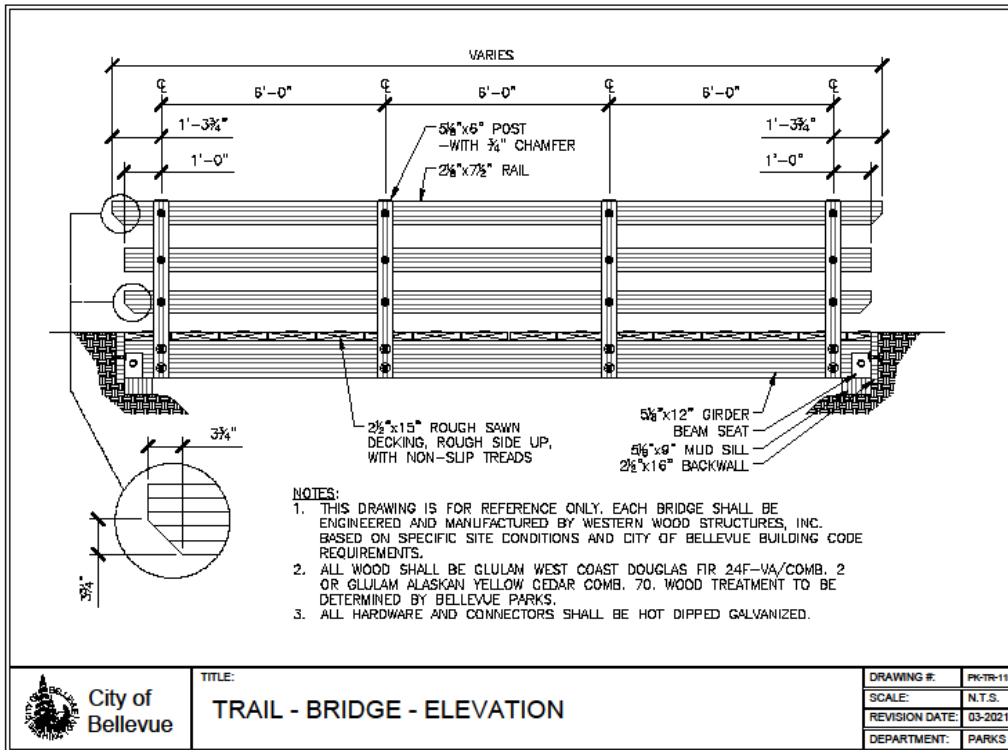

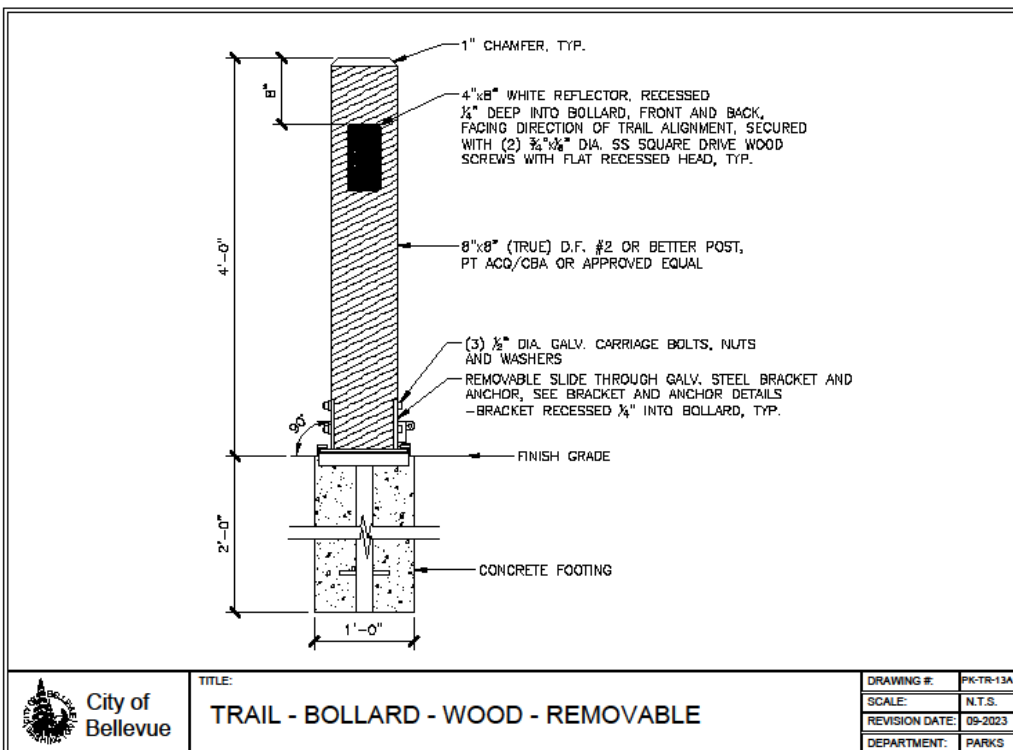
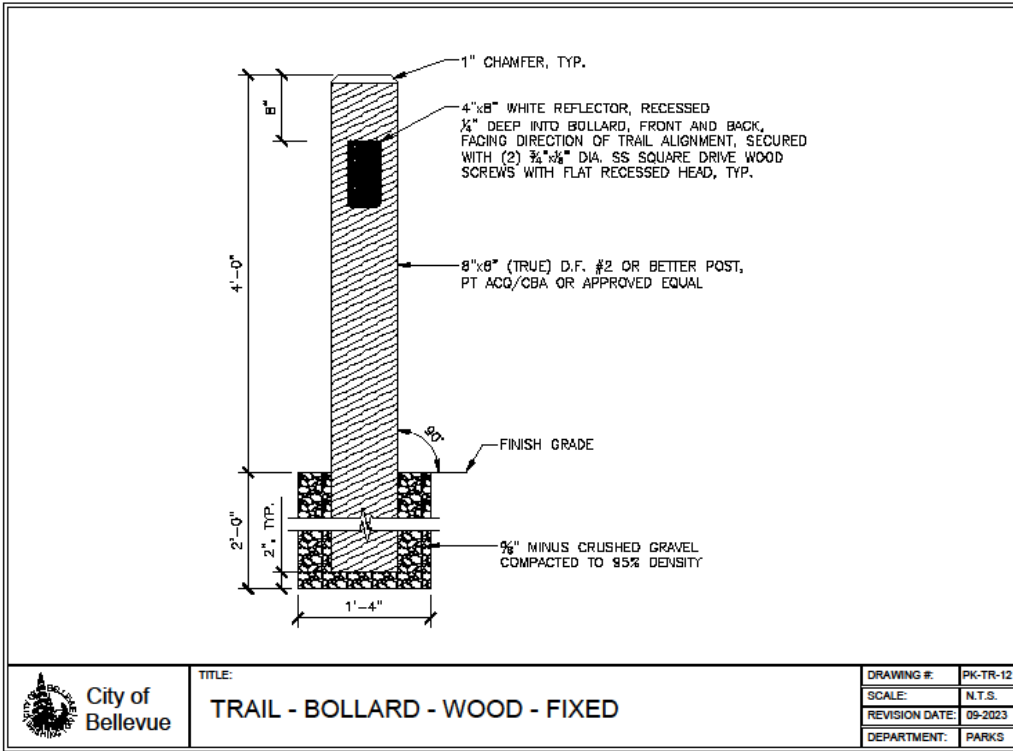

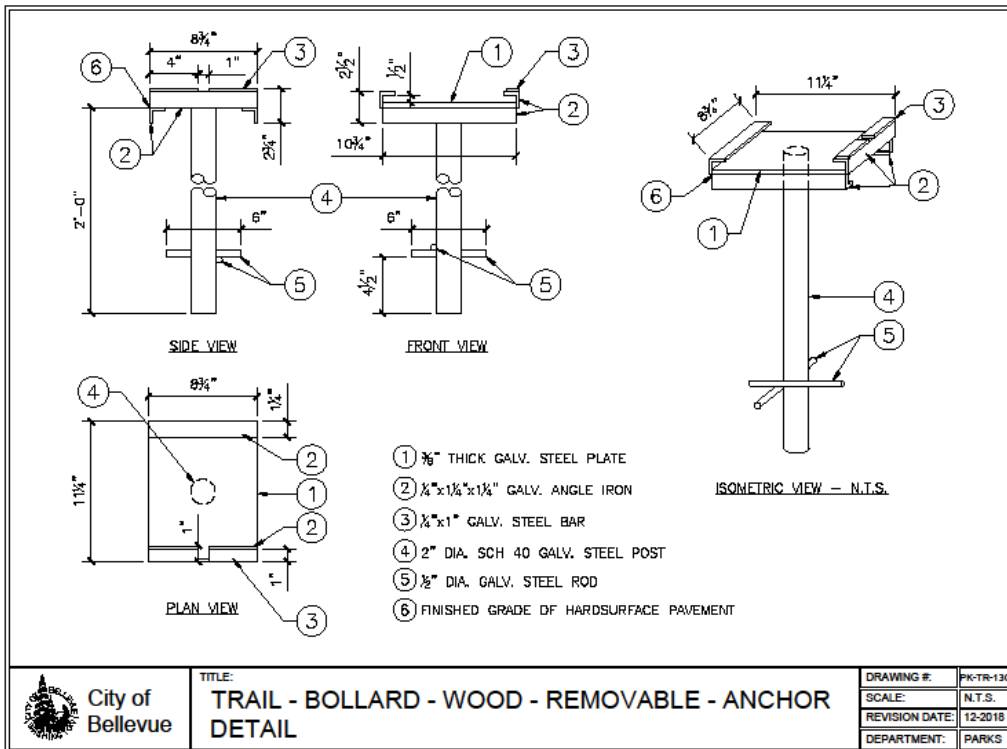
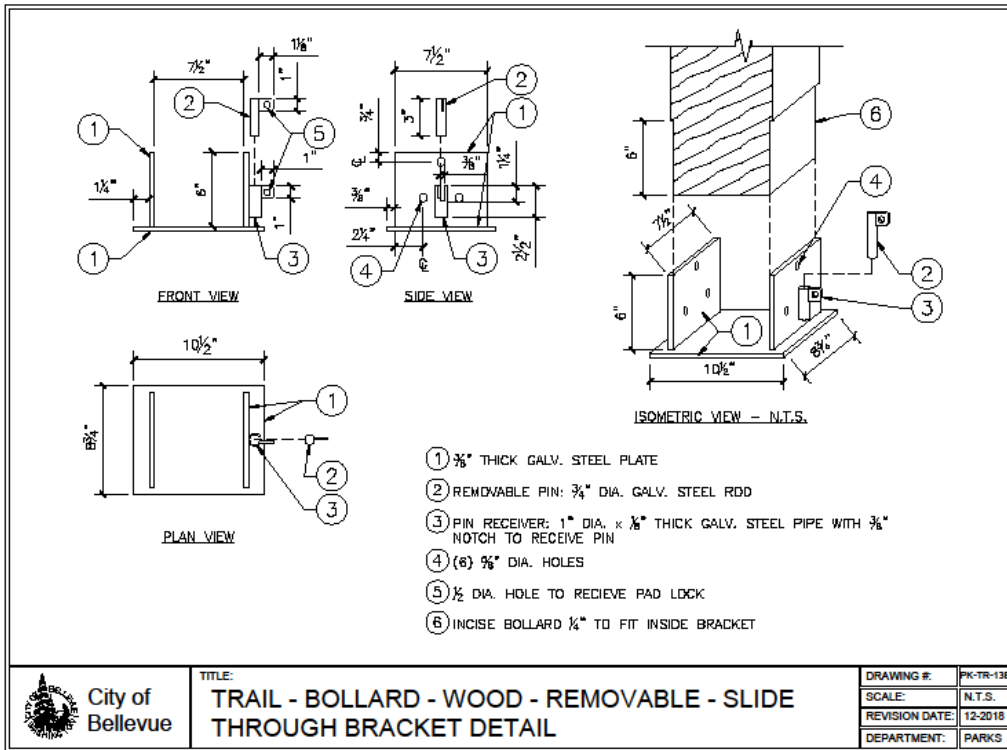

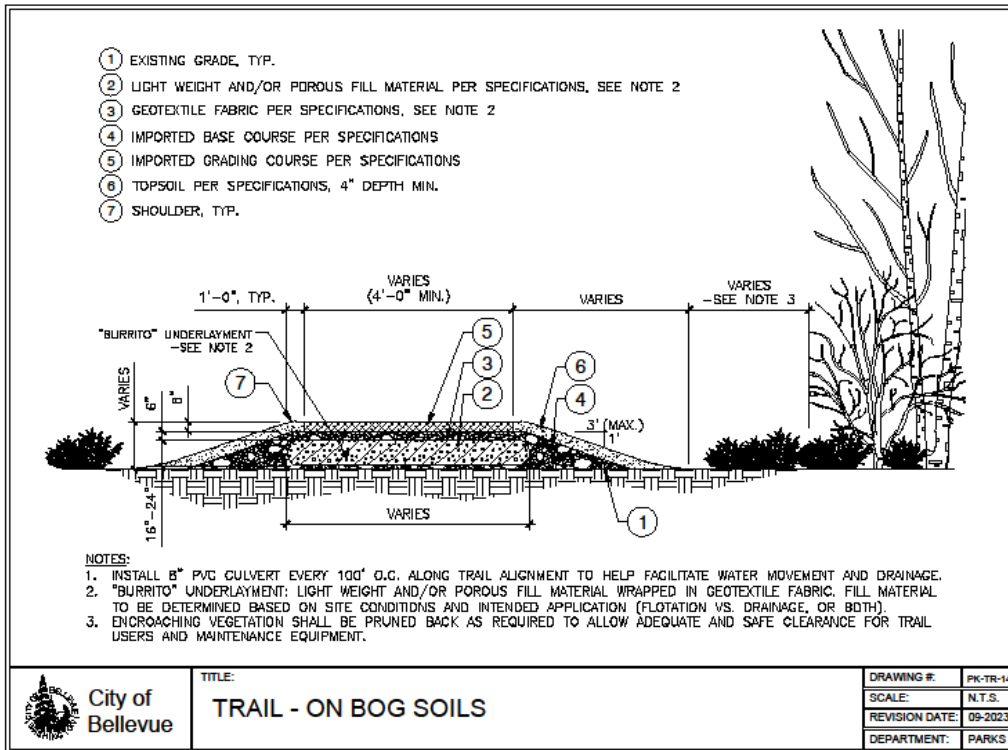



(This page intentionally left blank)

# Sport Fields

---





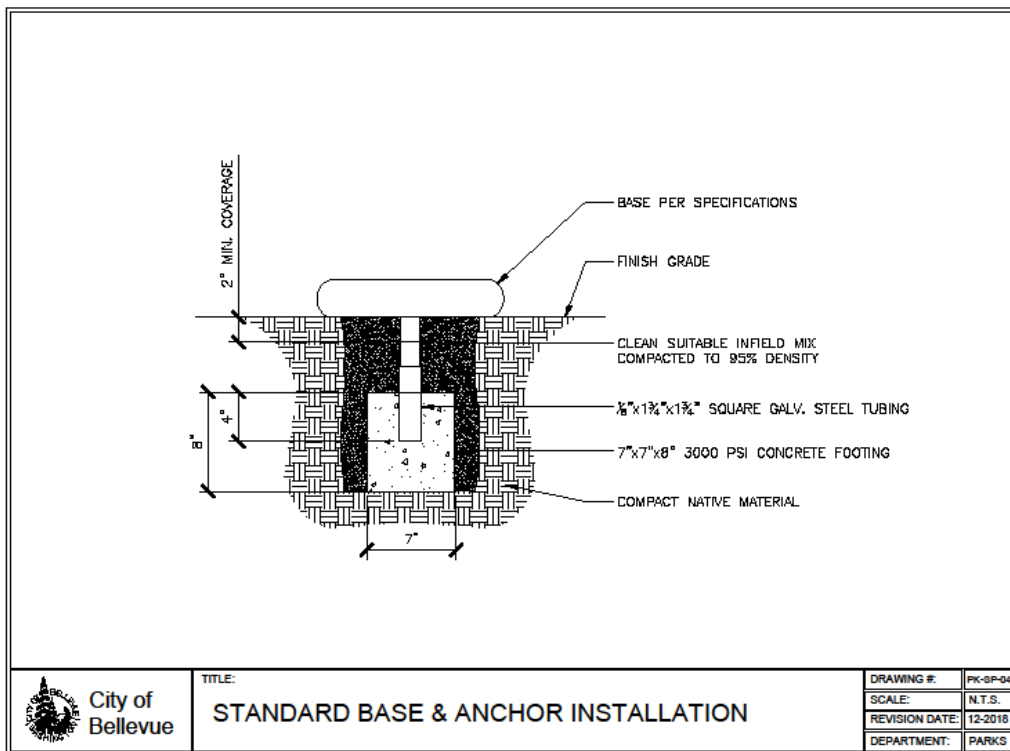
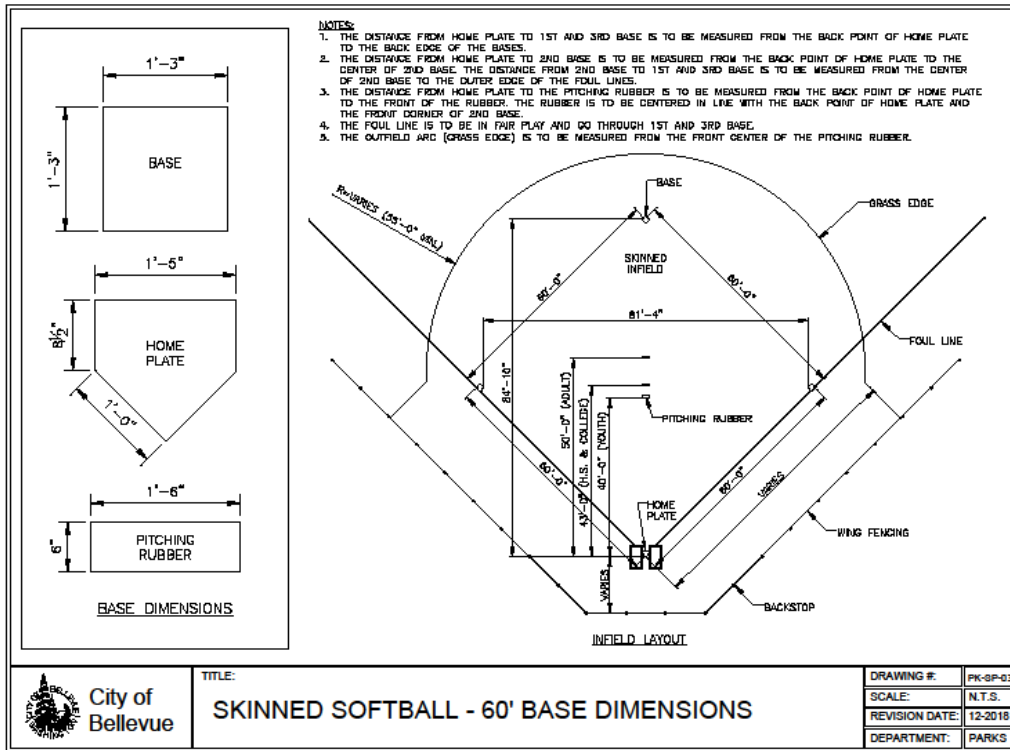

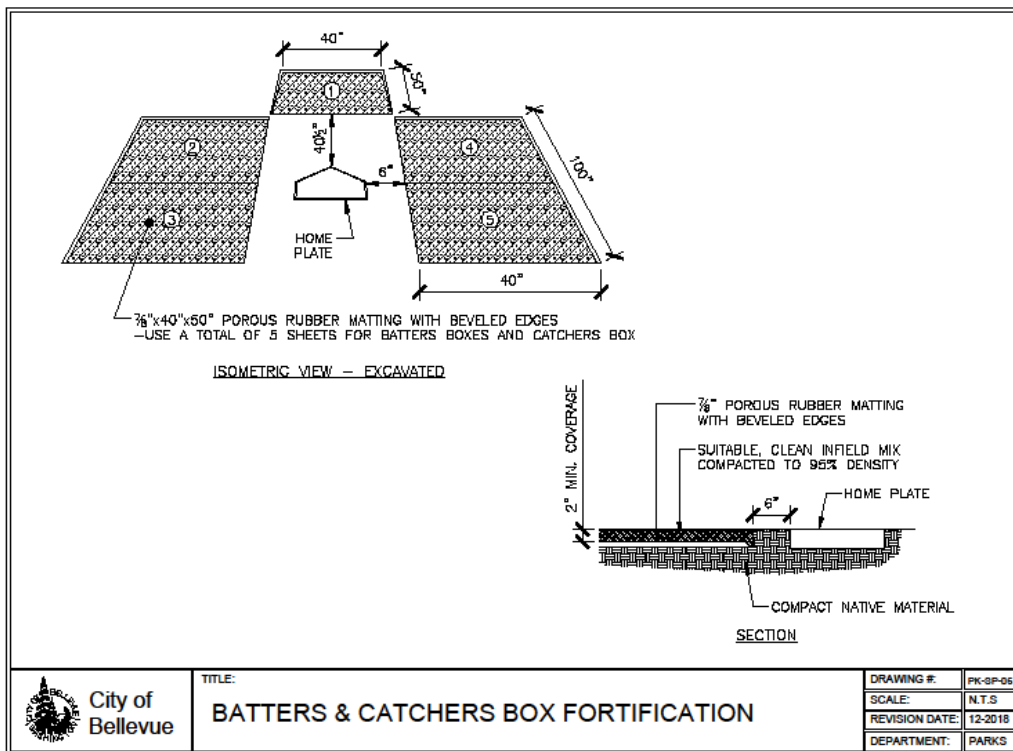
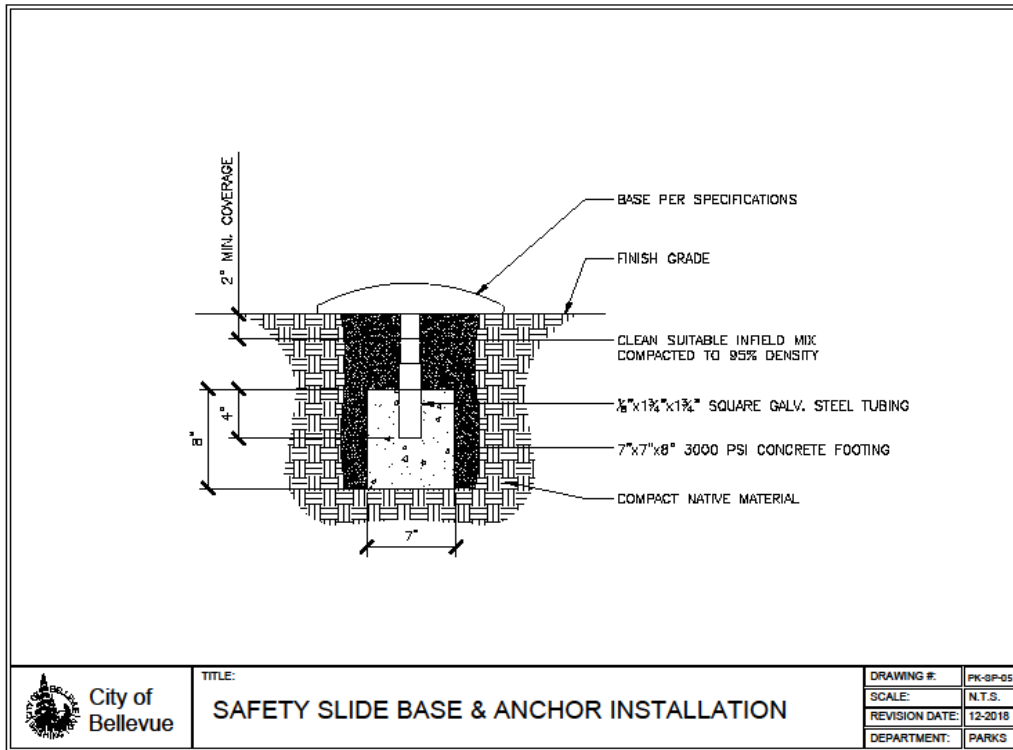

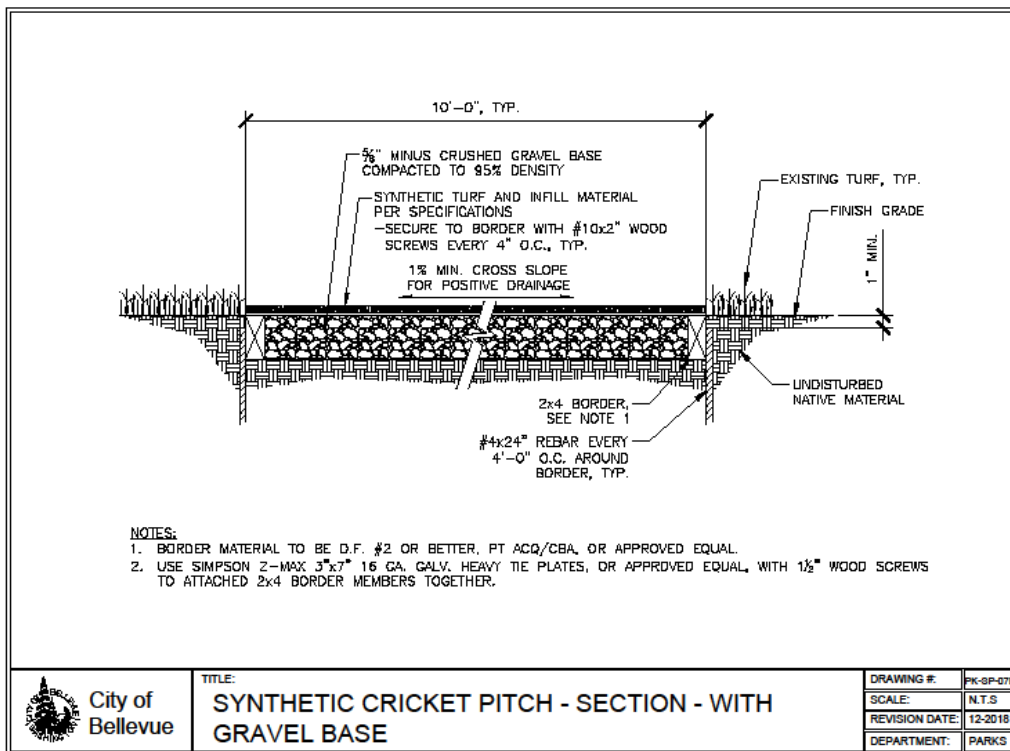
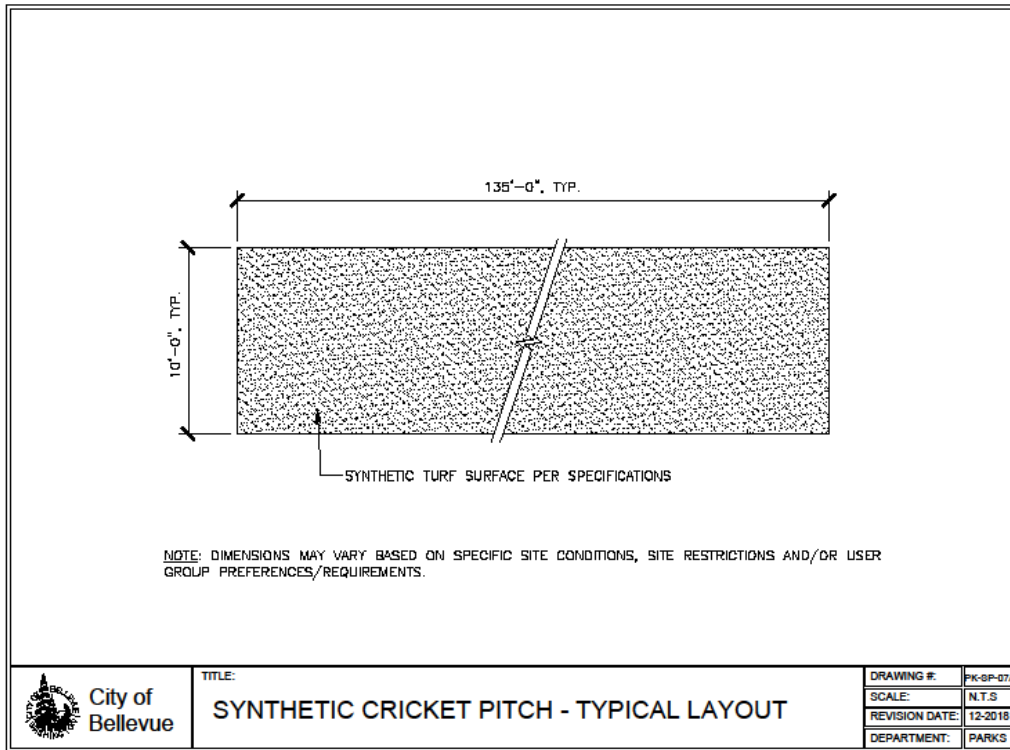

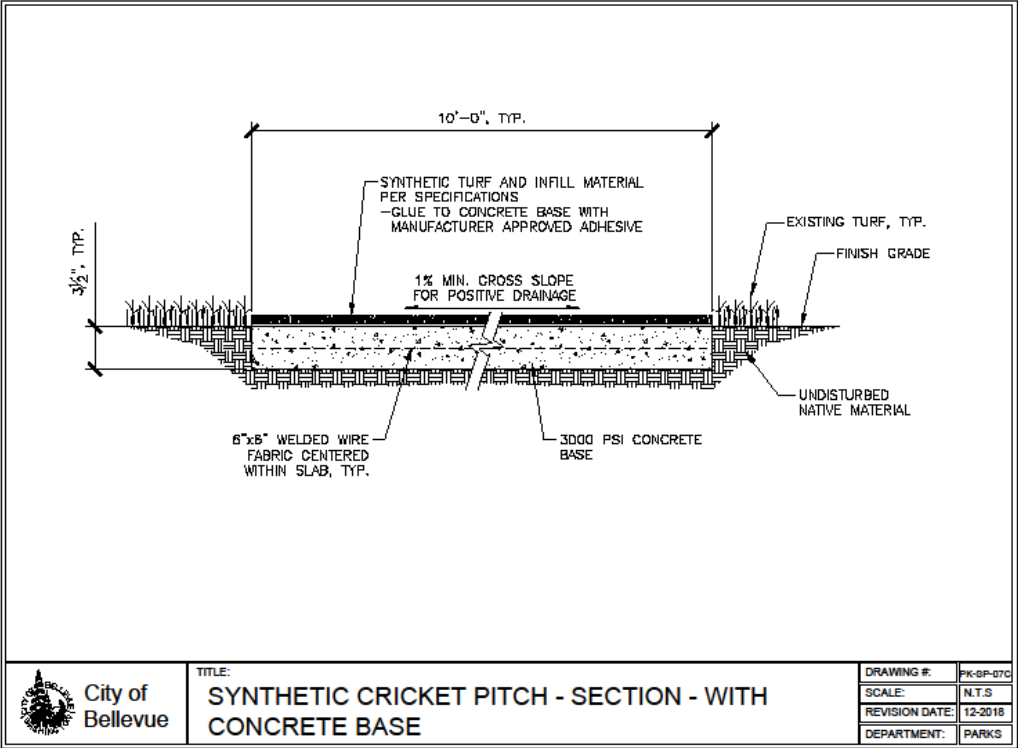

# Coal Creek Natural Area

---





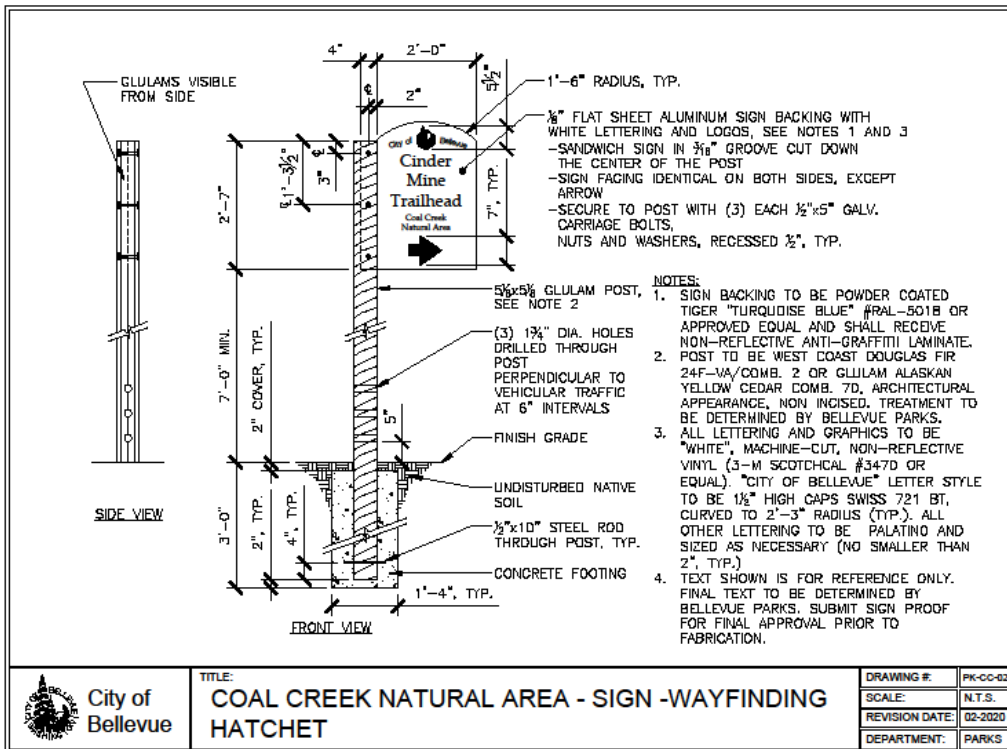
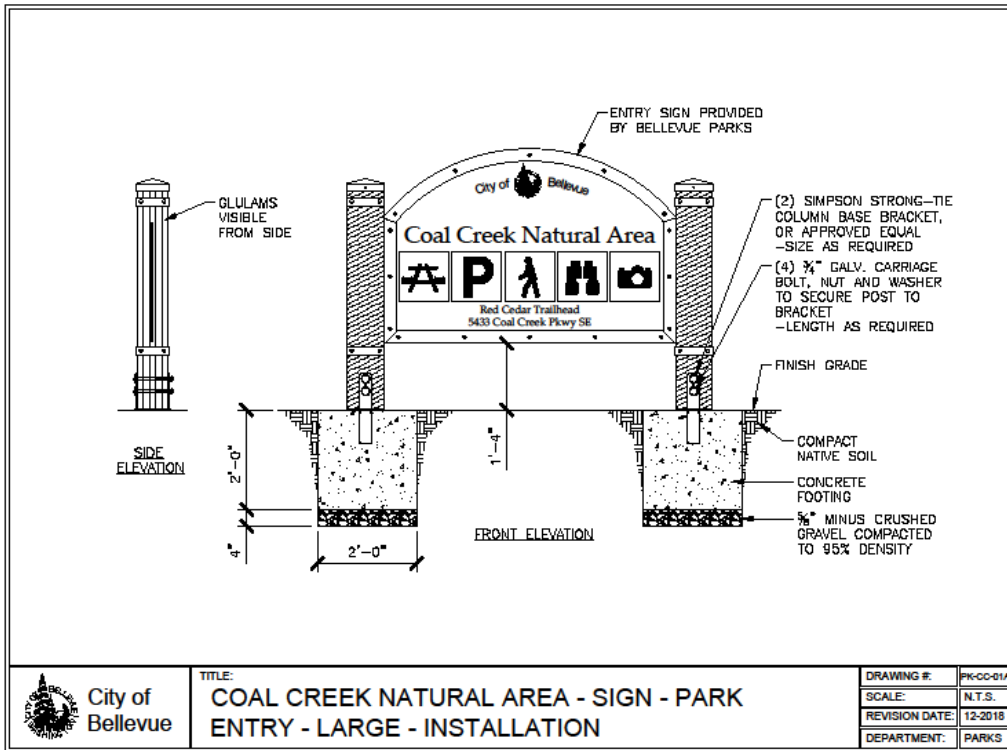

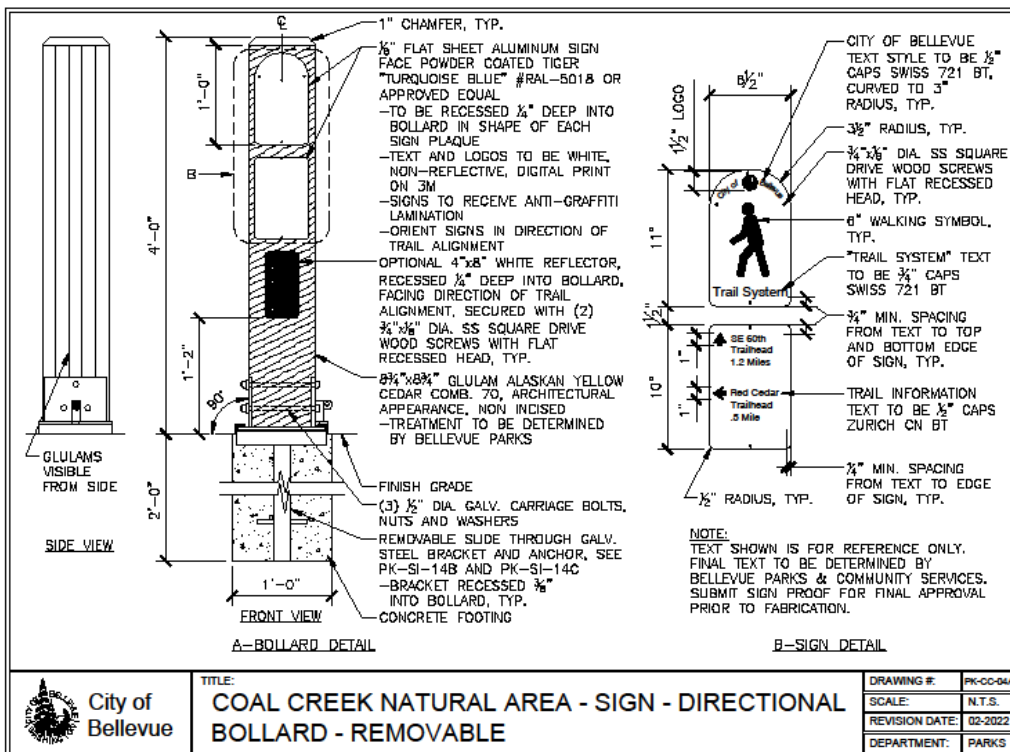
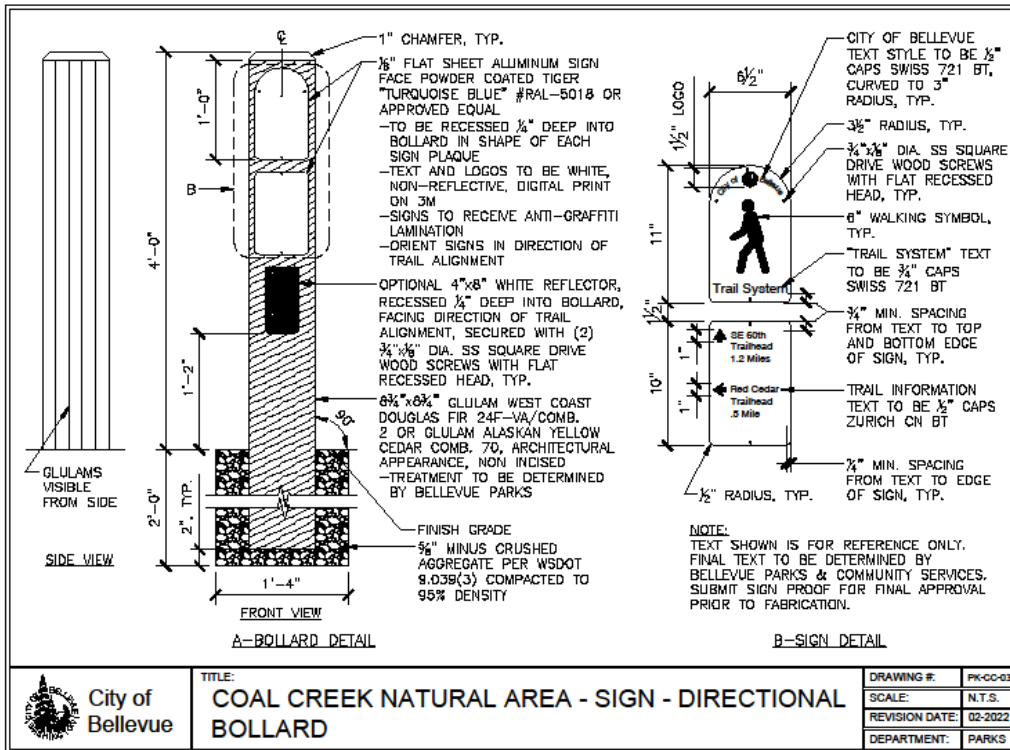

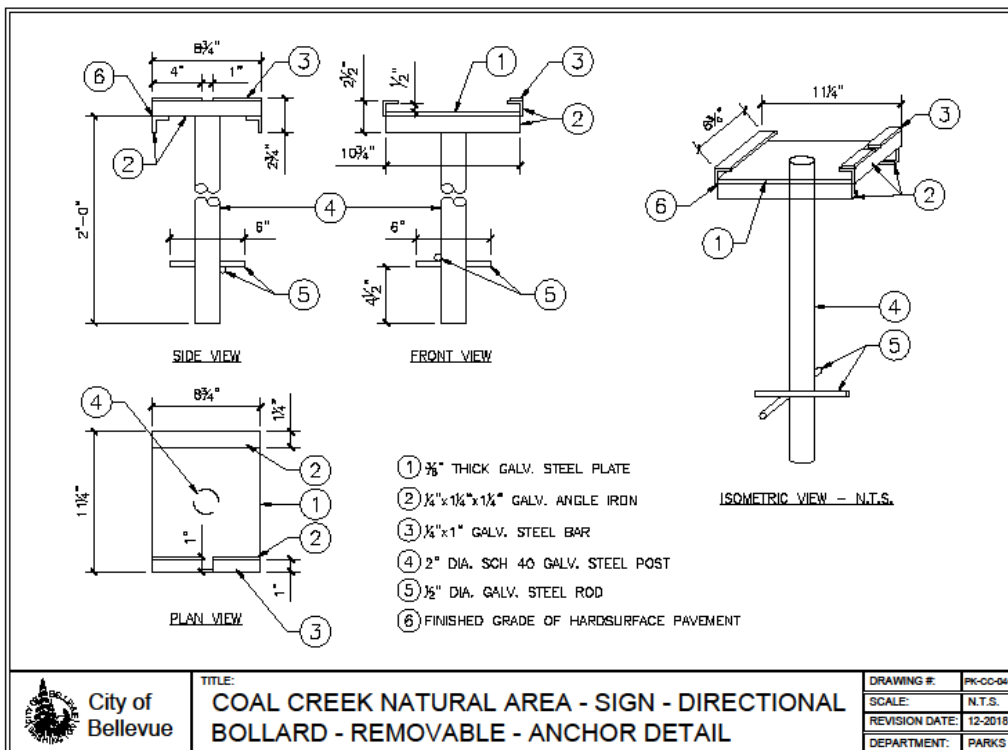
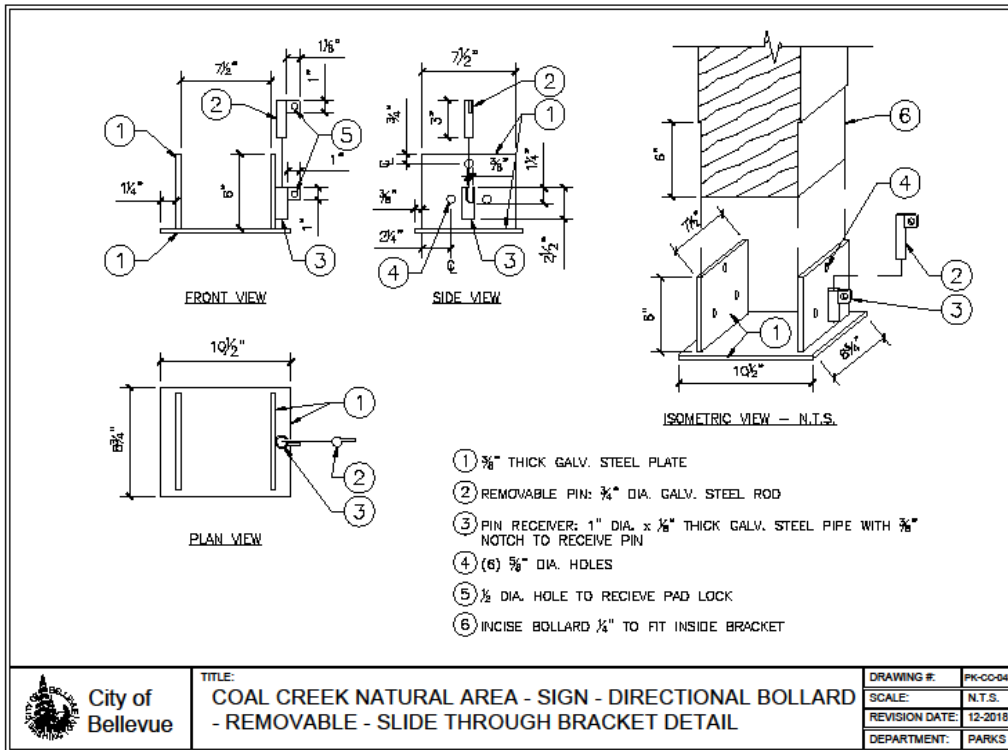

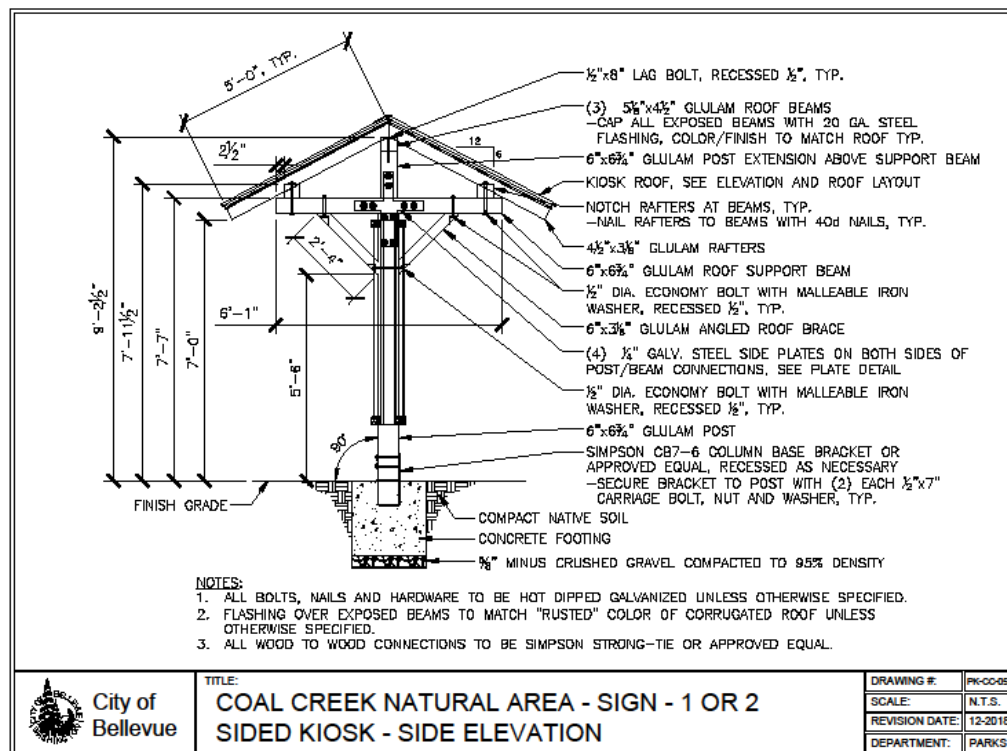
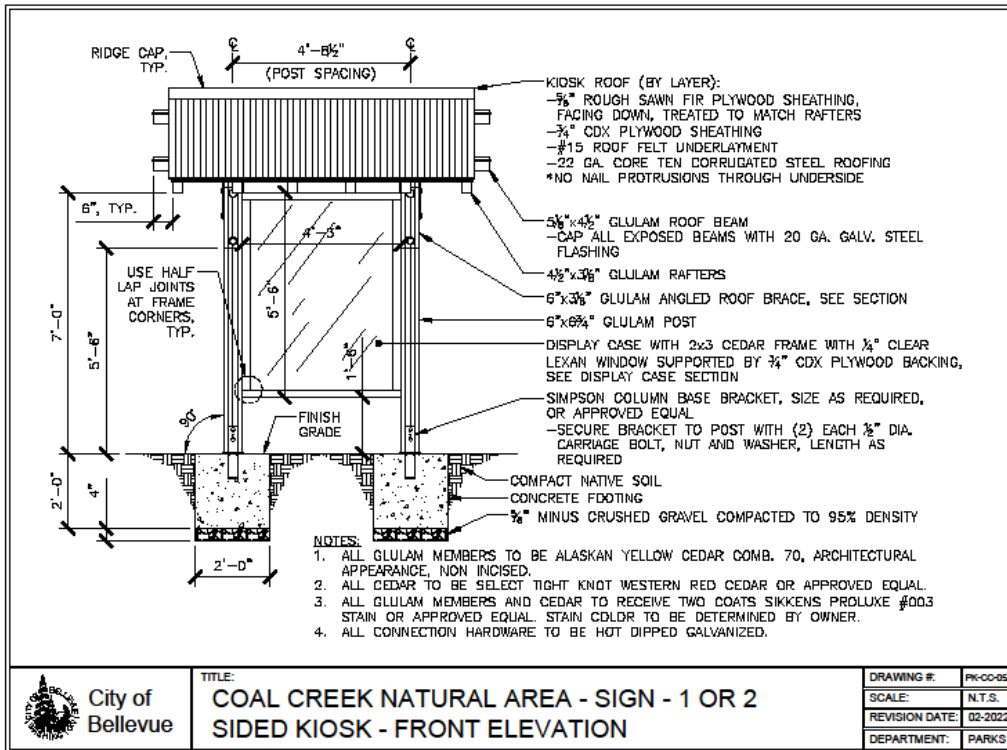

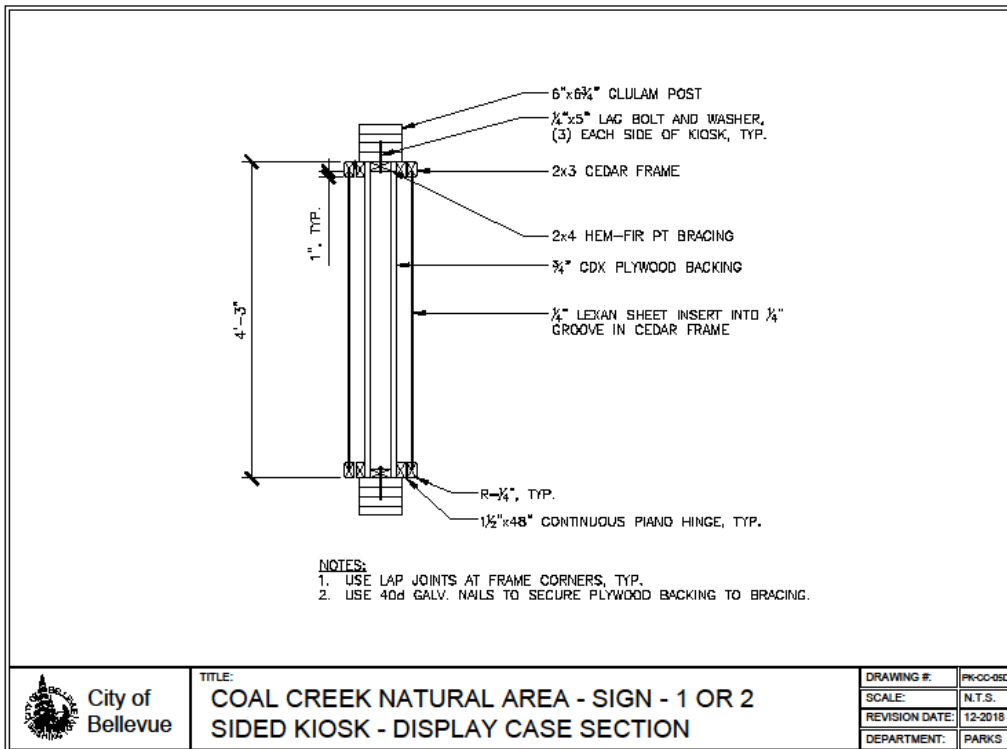
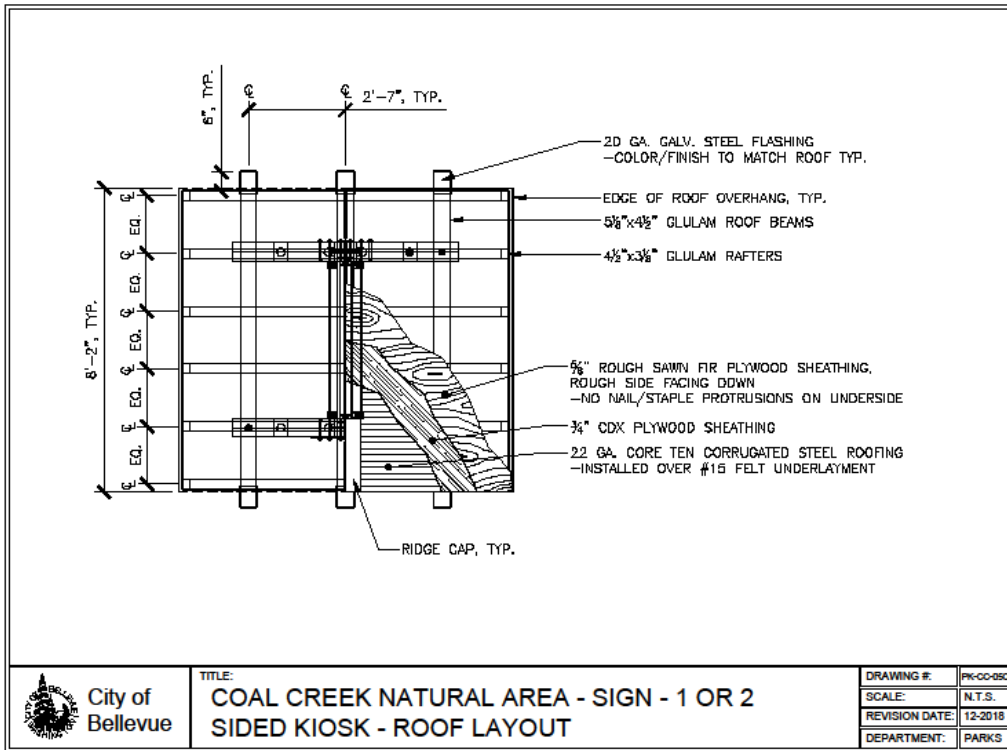









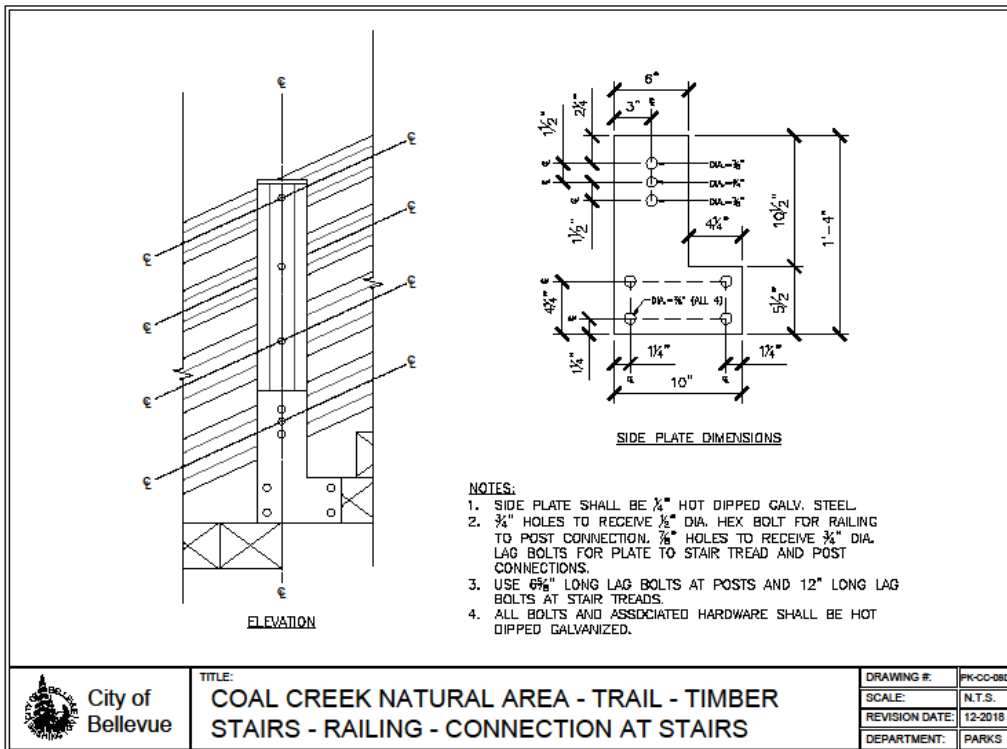
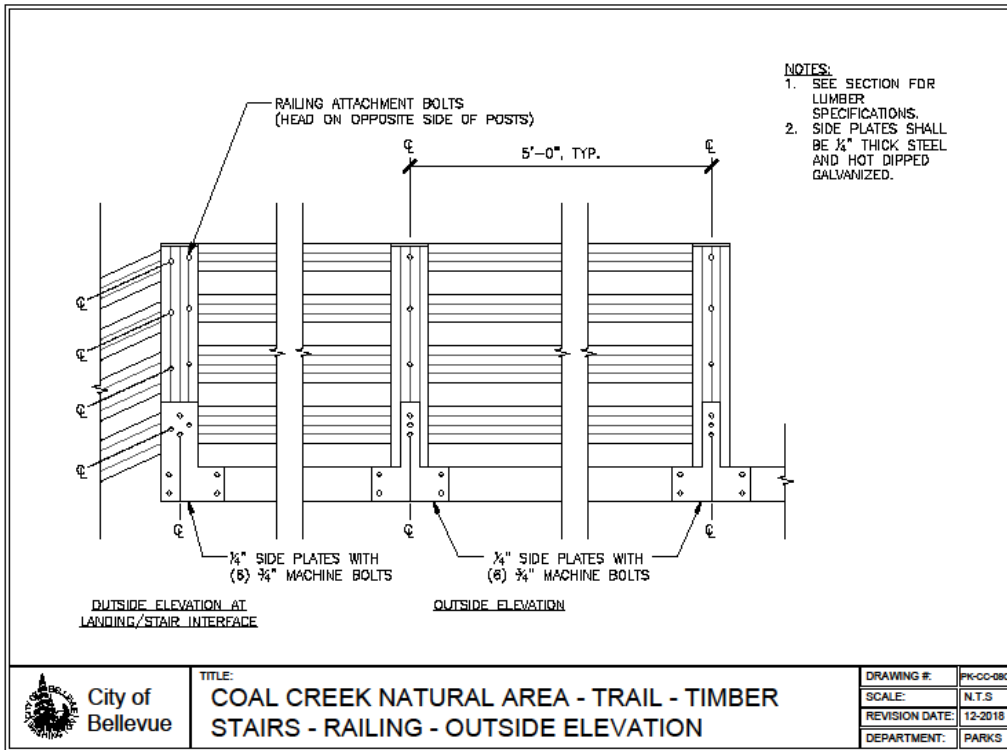

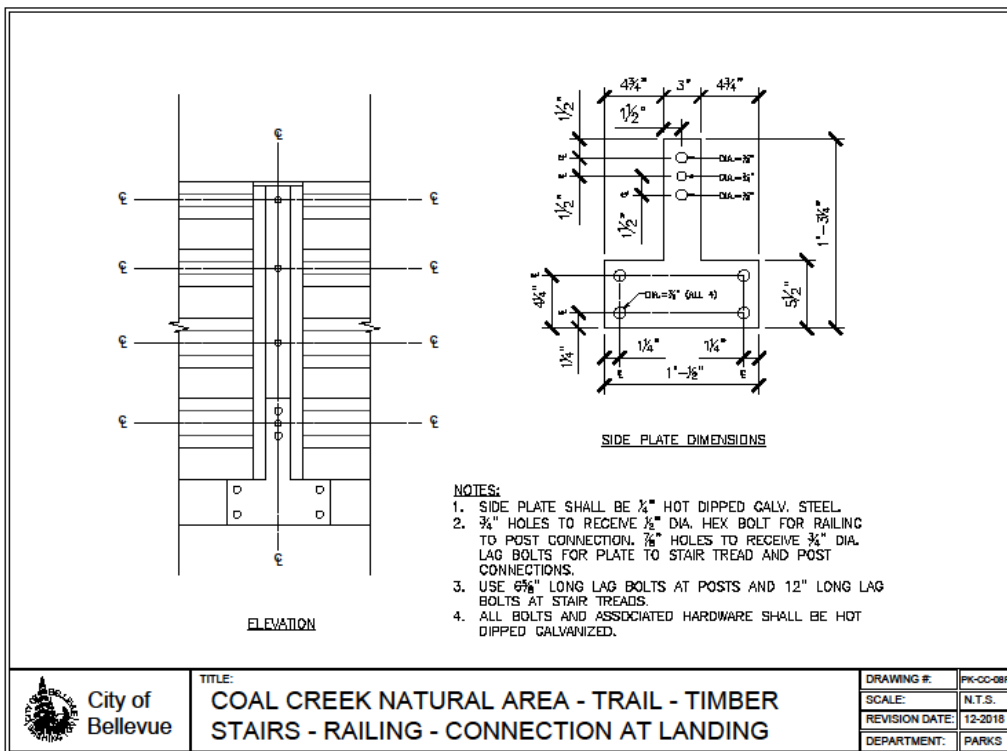
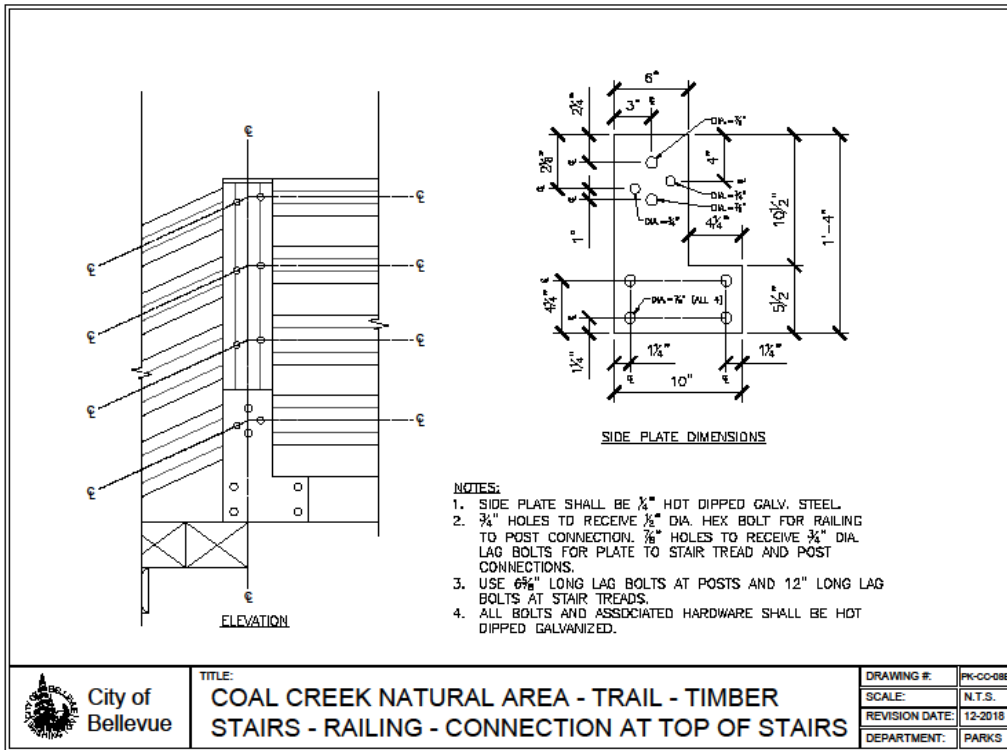

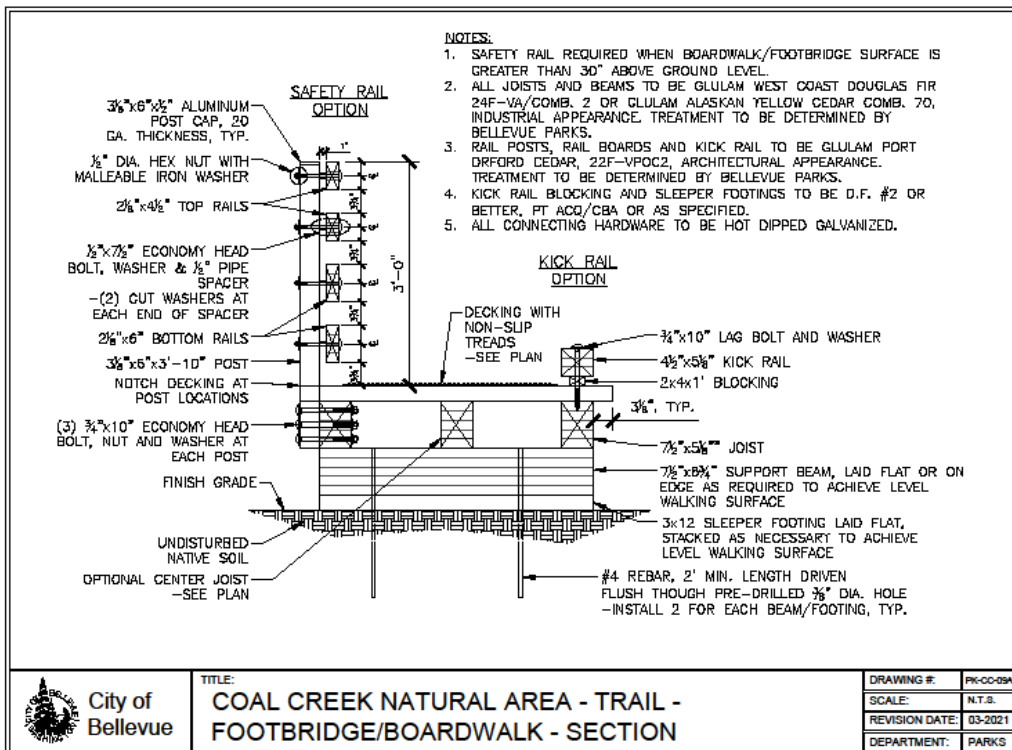
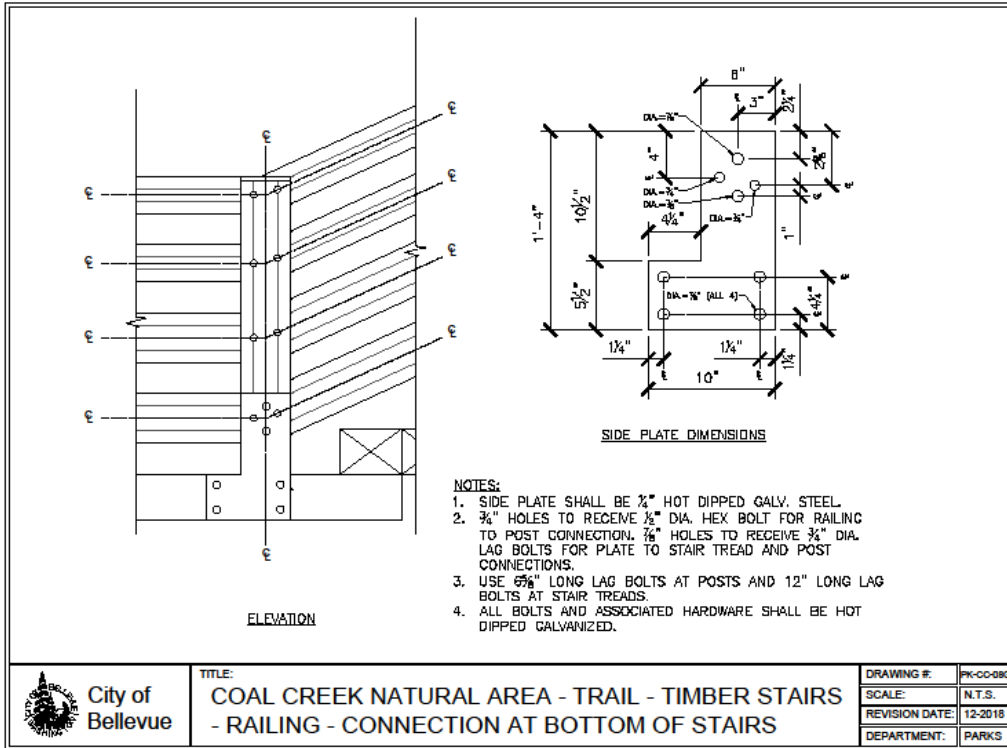

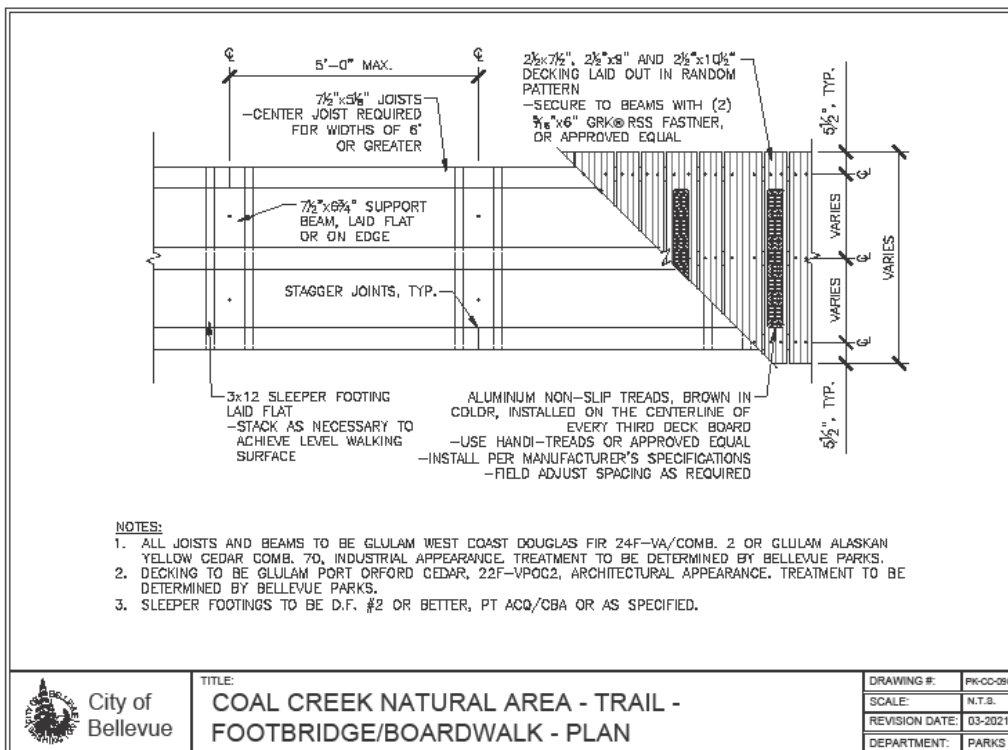
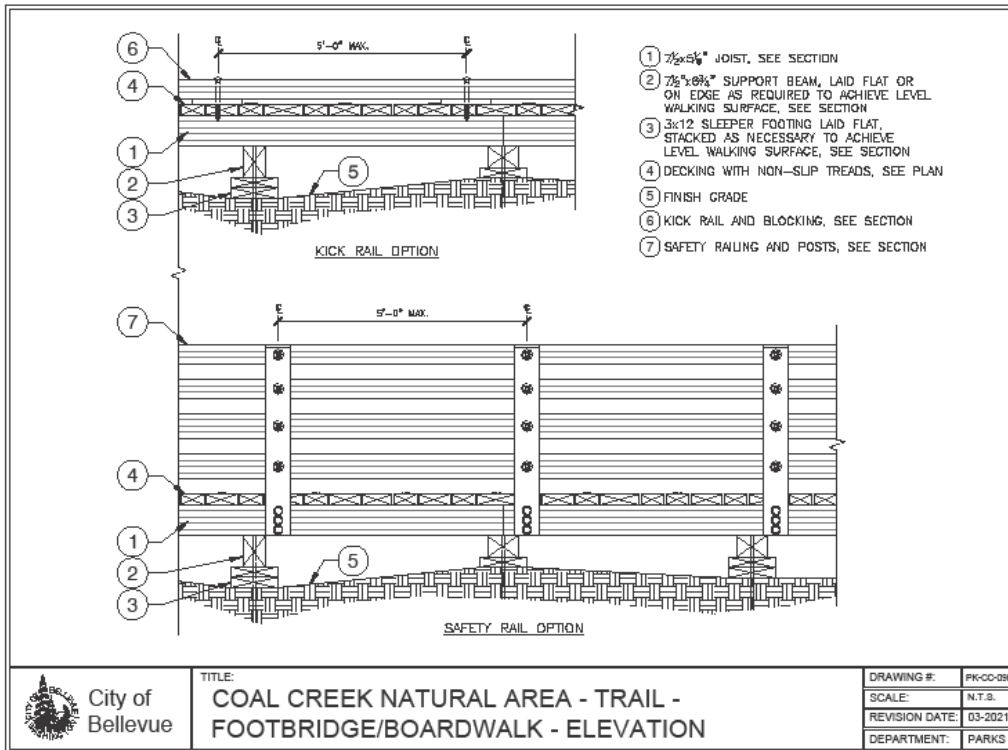

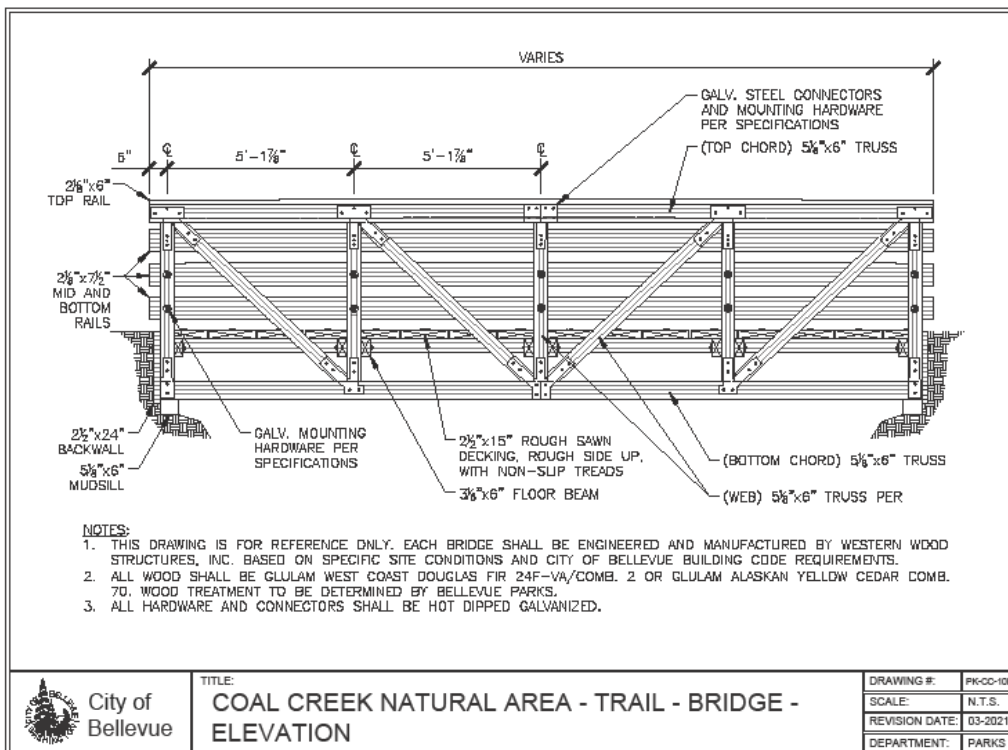
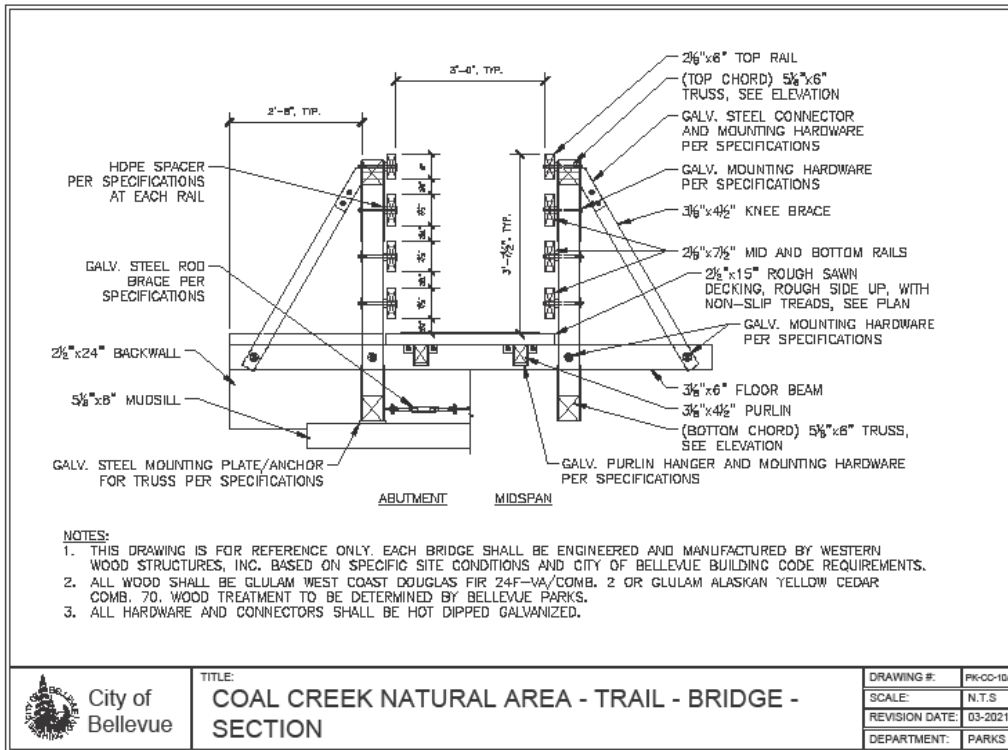

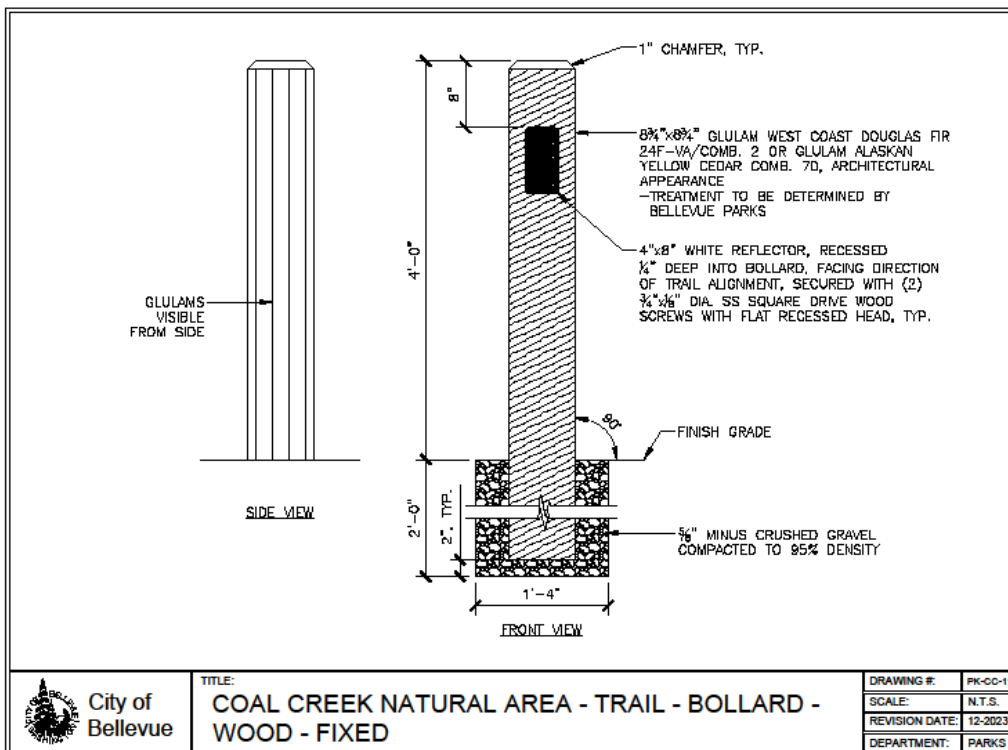
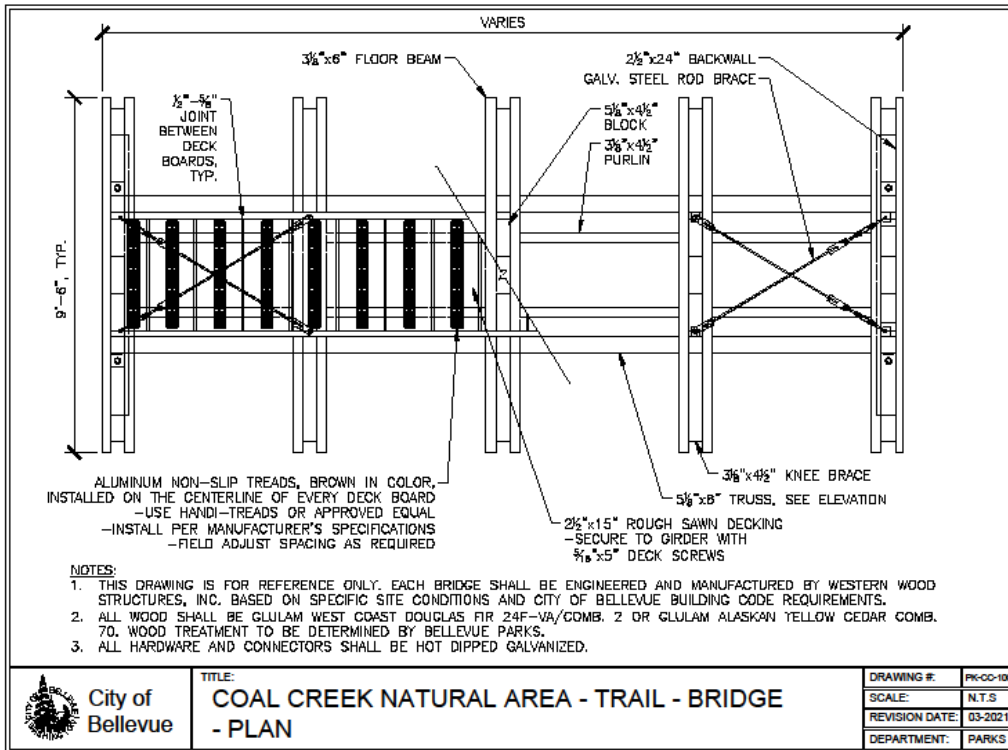

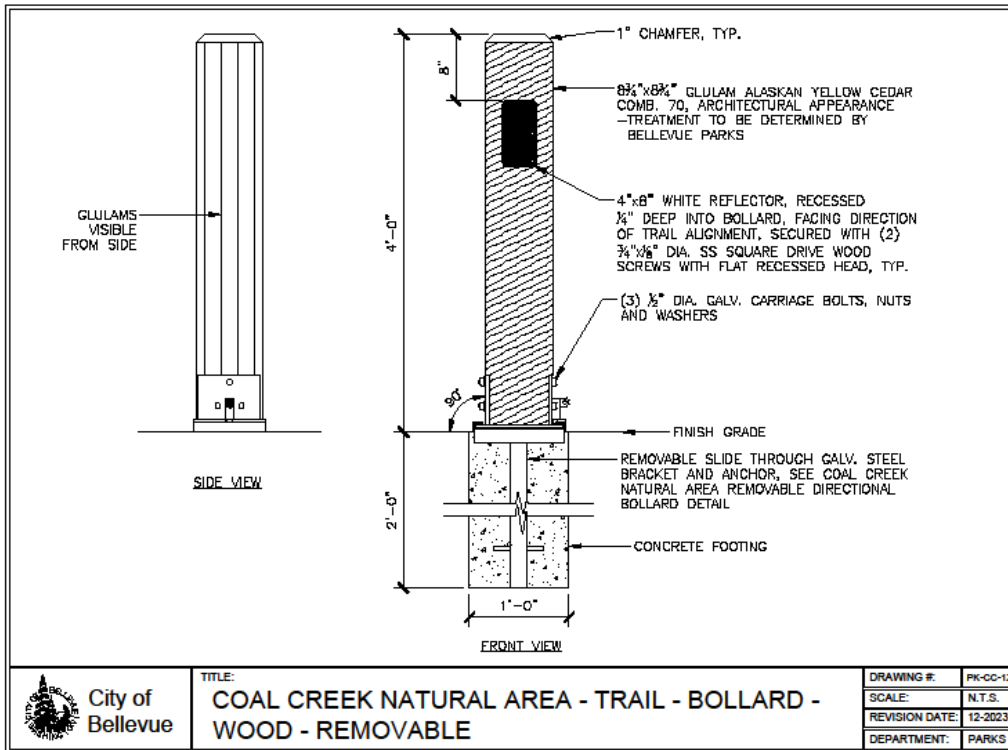

City of Bellevue

TITLE:

COAL CREEK NATURAL AREA - TRAIL - BOLLARD - WOOD - REMOVABLE

DRAWING #:	PK-CC-12
SCALE:	N.T.S.
REVISION DATE:	12-2023
DEPARTMENT:	PARKS