

1/4" LOOP SAWCUT CROSS-SECTION

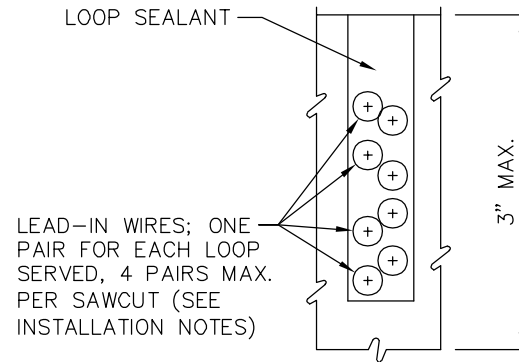

1/2" LEAD-IN SAWCUT CROSS-SECTION

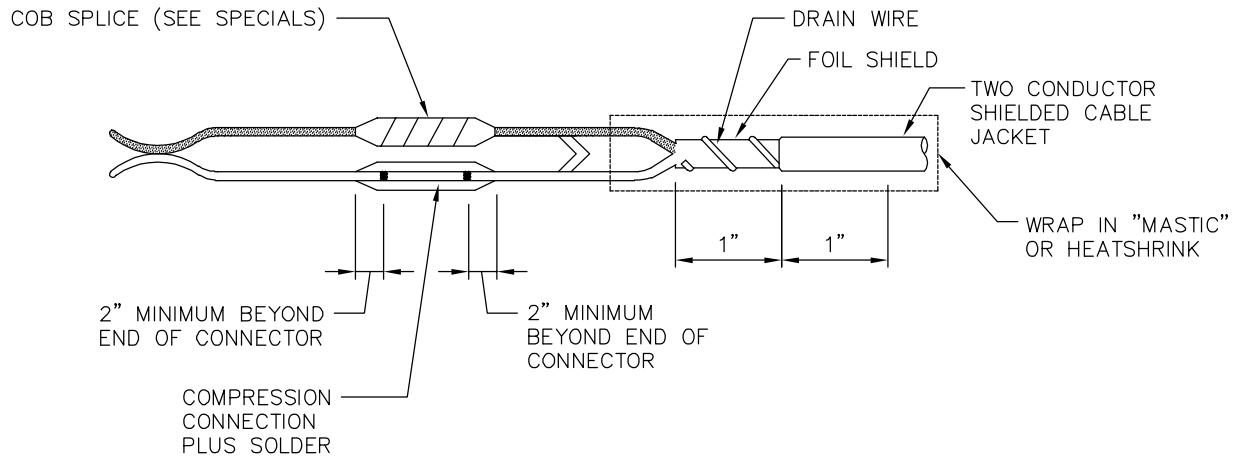

LOOP SPLICE



LOOP DETECTOR DETAIL

DRAWING NUMBER	SL-320-1
SCALE	NONE
REVISION DATE	12/22
DEPARTMENT	TRANS